



**SIRECKS
ENTERPRISES**

**High-Quality
Craftsmanship
for the World's
Demands**



**Surgical
Instruments
Catalogue**

Contact Us



+92 304 5908910



info@sirecksenterprises.com



Plot No. 46, Street No. 2
Aziz Garden, Sialkot 51310
Pakistan



www.sirecksenterprises.com

	Instruments Section	Page #
1	FORCEPS AND CLAMPS	04 -80
2	KNIFE HANDLES	81 -83
3	CVT FORCEPS AND CLAMPS	84-100
4	SCISSORS	101-150
5	BULLDOG	151 -164
	VASCULAR INSTRUMENTS	165 -279
6	VASCULAR CLAMPS	165 -248
7	SCISSORS	249 -266
8	CVT NEEDLE HOLDERS	267 -279
9	MOUTH AND THROAT INSTRUMENTS	280 -293
10	NAIL INSTRUMENTS	294 -301
11	NASAL INSTRUMENTS	302 -320
12	OB GYN	321 -361
13	OPHTHALMIC INSTRUMENTS	362 -391
14	PLASTER CAST INSTRUMENTS	392 -395
15	PLIERS	396 -409
16	TITANIUM INSTRUMENTS	410 -437
17	CURETTES	438 -450
18	LAPAROSCOPIC INSTRUMENTS	451 -469
19	LARYNGOSCOPES & SUBGLOTTISCOPE	470 -518
20	UROLOGY	519 -525
21	VALVE INSTRUMENTS	526 -536
22	VIDEO-ASSISTED	537 -549
23	DISSECTORS AND ELEVATORS	550 -567
24	EAR INSTRUMENTS	568 -578
25	ELECTRO SURGERY	579 -584
26	MISCELLANEOUS GENERAL	585 -598
27	MISCELLANEOUS ORTHOPEDIC	599 -606
28	CVT RETRACTORS	607 -638

#	Instruments Section	Page #
29	RETRACTORS, HAND-HELD	639 -680
30	RETRACTORS, SELF-RETAINING	681 - 703
31	ORTHOPEDIC RETRACTORS	704 - 740
32	RIB INSTRUMENTS	741 - 747
33	RONGEURS	748 - 792
34	BENDING IRONS AND ROG HOLDERS	793 - 797
35	BONE CUTTING FORCEPS	798 - 801
36	BONE FILES AND RASPS	802 - 810
37	BONE HOLDING INSTRUMENTS	811 - 839
38	BONE SAWS AND KNIVES	840 - 843
39	BOUGIES AND TRACHEOSTOMY TUBES	844 - 866
40	BRONCHOSCOPES	867 - 873
41	CARTILAGE AND TENDON INSTRUMENTS	874 - 881
42	CHISELS AND GOUGES	882 - 891
43	ESOPHAGOSCOPES	892 - 910
44	EXTENDED LENGTHOPEN	911 - 924
45	FLOOR GRADE INSTRUMENTS	925 - 933
46	MALLETS	934 - 942
47	MEDIASTINOSCOPY	943 - 949
48	MICRO CLIPS AND APPLIERS	950 - 957
49	NEEDLE HOLDERS	958 - 993
50	OSTEOTOMES	994 - 1002
51	RECTAL	1003 - 1012
52	SCREWDRIVERS	1013 - 1021
53	SPECIALTY SETS	1022 - 1028
54	SUCTION TUBES	1029 - 1035
55	WIRE AND PIN IMPLANTS	1036 - 1060
56	WIRE GUIDES AND DRILL BITS	1061 - 1079
57	MEASURING DEVICES	1080 - 1091

FORCEPS AND CLAMPS

FORCEPS AND CLAMPS

Sponge Forceps

BALLENGER SPONGE FORCEPS



121412

Catalog #	Description
121410	Straight, smooth jaws, 7-1/4" (18.5 cm)
121412	Straight, serrated jaws, 7-1/4" (18.5 cm)
121422	Curved, serrated jaws, 7" (18 cm)

FOERSTER SPONGE FORCEPS



121417

. Pattern, satin finish.

Catalog #	Description
121415	Straight, smooth jaws, 9-3/4" (25 cm)
121417	Straight, serrated jaws, 9-3/4" (25 cm)
121427	Curved, serrated jaws, 9-1/2" (24 cm)

FOERSTER SPONGE FORCEPS



454100

Weck® Pattern, bright finish.

Catalog #	Description
454100	Straight, cross serrated jaws, 9-1/2" (24 cm)

FORCEPS AND CLAMPS

Tubing Clamps

GUNNAR ROLLER CLAMPS



Catalog #	Description
351390	For "milking" pump tubing 1/2" (12.5 mm) diameter, 7-1/8" (18 cm)

LORE TUBE HOLDING FORCEPS



Full serrations, serrated jaws grasp drape without puncturing. Fitting on shanks holds tubing securely and without drag when not in use. Suction tube may be stored in protective metal sleeve.

Catalog #	Description
536275	Angled, 2.6 mm tip, 6-1/4" (16 cm)

MORSE TOWEL CLIP TUBING HOLDERS



For holding extracorporeal tubing to drapes giving positive fixation. The serrated inner surface of the tube holding ring closes down on the tubing but does not collapse or reduce the lumen. Sizes listed are for outside diameter of extracorporeal tubing.

Catalog #	Description
351351	For 3/16" and 1/4" tubing
351352	For 5/16" and 3/8" tubing
351353	For 7/16" and 1/2" tubing
351354	For 9/16" and 5/8" tubing
351355	For 11/16" and 3/4" tubing

FORCEPS AND CLAMPS

Tubing Clamps

NICHOLS TUBING HOLDER

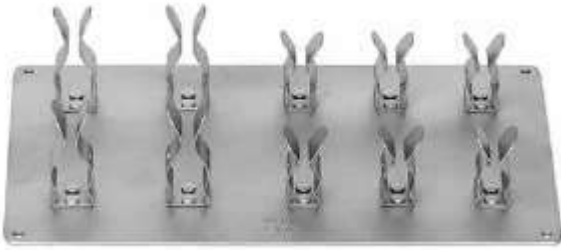

351370

Specially designed to hold and support the weight of the various diameters of tubing used by the pump-oxygenator, keeping them "in-line."

Catalog #
351370

Description
4-1/2" x 7-1/4" (11.4 x 18.5 cm) metal plate is perforated so it may be held in place with towel clamps.

PRESBYTERIAN HOSPITAL TUBING CLAMP



351358

Durable construction with smooth jaws for clamping off tubing without damage.

Catalog #
351358

Description
6-1/2" (16.5 cm)

FORCEPS AND CLAMPS

Tubing Clamps

VORSE TUBING OCCLUDING CLAMPS



351374

Heavy construction with jaws designed for positive occlusion of Silastic®, Tygon® and similar thick-walled tubings.

Catalog #	Description
351373	For tubing 1/4" I.D. (3/8" O.D.), 6-1/8" (15.5 cm)
351374	For tubing 3/8" I.D. (5/8" O.D.), 7-3/8" (18.5 cm)
351375	For tubing 1/2" I.D. (7/8" O.D.), 8-1/8" (20.5 cm)

VORSE TUBING OCCLUDING CLAMPS WITH SAFETY GUARD



351377

The familiar Vorse-type tube-occluding clamp supplied with a safety guard to prevent the box-lock from puncturing the tubing. Heavy construction with jaw designed for positive non-slip occlusion of Silastic®, Tygon® and similar thick-walled tubing.

Catalog #	Description
351376	For tubing 1/4" I.D. (3/8" O.D.), 6-1/8" (15.5 cm)
351377	For tubing 3/8" I.D. (5/8" O.D.), 7-3/8" (18.5 cm)
351378	For tubing 1/2" I.D. (7/8" O.D.), 8-1/8" (20.5 cm)

FORCEPS AND CLAMPS

TowelClamps

EDNA TOWEL FORCEPS



Catalog #
121655
121656

. Pattern, satin finish.

Description
Single row of non-penetrating teeth, 5-1/2" (14 cm)
4" (10 cm)

EDNA NON-PERFORATING TOWEL CLAMPS

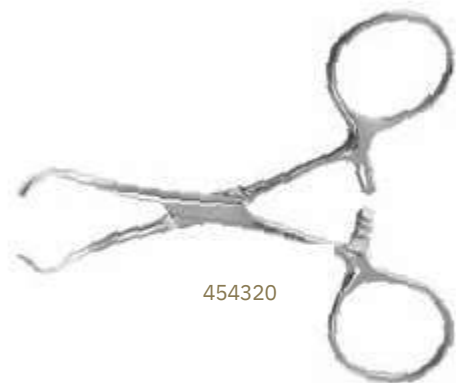

Weck® Pattern, bright finish.

Catalog #
454320
454322

Description
3-3/4" (9.5 cm)
5-3/8" (13.5 cm)

FORCEPS AND CLAMPS

TowelClamps

BACKHAUS TOWEL CLAMPS



454305

Weck® Pattern, bright finish.

Catalog #	Description
454300	3-1/2" (9 cm)
454305	5-1/4" (13.5 cm)

BACKHAUS TOWEL FORCEPS



121600

. Pattern, satin finish.

Catalog #	Description
121605	3-1/2" (9 cm)
121600	5-1/4" (13.5 cm)

BACKHAUS TOWEL FORCEPS



447050

Catalog #	Description
447050	3-1/2" (9 cm)

FORCEPS AND CLAMPS

Towel Forceps

JONES CROSS-ACTION TOWEL FORCEPS



121640

Catalog #	Description
121640	3-1/2" (9 cm)

PEERS TOWEL FORCEPS



121650

Double opposing row of non-penetrating teeth.

Catalog #	Description
121650	5-3/4" (14.5 cm)

ROEDER TOWEL FORCEPS



121610

Catalog #	Description
121610	With ball stops, 5-1/4" (13.5 cm)

FORCEPS AND CLAMPS

Splinter Forceps

CARMALT SPLINTER FORCEPS



Catalog #	Description
GS39410	Straight, serrated, 4-3/8" (11 cm)
GS39412	Curved, serrated, 4-3/8" (11 cm)



GS39412

FEILCHENFELD SPLINTER FORCEPS



Catalog #	Description
GS39386	Straight, serrated, 3-1/4" (8.5 cm)
GS39390	Straight, serrated, 4-1/2" (11.5 cm)



GS39386

PLAIN SPLINTER FORCEPS



Catalog #	Description
GS39364	Straight, serrated, 3-1/2" (9 cm)
GS39366	Straight, serrated, 0.6 mm tip, 4-1/2" (11.5 cm)

GS39364

SPLINTER FORCEPS



Catalog #	Description
181556	Straight, serrated, 3-1/8" (8 cm)
181557	Straight, serrated, 4" (10 cm)
181559	Straight, serrated, 5" (12.5 cm)

181559

FORCEPS AND CLAMPS

Splinter Forceps

VANGUARD SPLINTER LIBERATOR

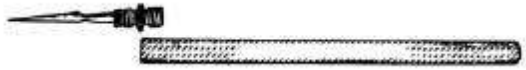

GS39534

Catalog #	Description
GS39534	Trocar in reversible handle, 5" (12.5 cm)
GS39536	Trocar point only

VIRTUS SPLINTER FORCEPS



GS39478

Catalog #	Description
GS39478	Straight, serrated, 6" (15 cm)

WILLIAMS SPLINTER FORCEPS



GS39509

GS39511

GS39513

Catalog #	Description
GS39509	Straight, serrated, 5-1/2" (14 cm)
GS39511	45 degree angled, serrated, 5-1/4" (13.5 cm)
GS39513	90 degree angled, serrated, 5-1/2" (14 cm)

FORCEPS AND CLAMPS

Dressing Forceps

THUMB DRESSING FORCEPS



181106

. Pattern, satin finish. Standard, serrated tips.

Catalog #	Description
181102	2.7 mm tip, 5" (12.5 cm)
181104	3.4 mm tip, 5-1/2" (14 cm)
181106	3.5 mm tip, 6" (15 cm)
181108	4 mm tip, 7-1/4" (18.5 cm)

THUMB DRESSING FORCEPS



465115

Weck® Pattern, bright finish. Standard, serrated tips.

Catalog #	Description
465100	2.6 mm tip, 4-5/8" (11.5 cm)
465105	2.7 mm tip, 5" (12.5 cm)
465110	3 mm tip, 5-5/8" (14.5 cm)
465115	3.5 mm tip, 6-1/4" (16 cm)
465120	3.6 mm tip, 7-7/8" (20 cm)
465125	4 mm tip, 9-7/8" (25 cm)
465130	4.7 mm tip, 12" (30.5 cm)

THUMB FORCEPS



465160

Weck® Pattern, bright finish. Narrow, serrated tips.

Catalog #	Description
465150	2 mm tip, 4-5/8" (11.5 cm)
465155	2 mm tip, 5" (12.5 cm)
465160	2 mm tip, 5-5/8" (14.5 cm)
465165	2 mm tip, 6" (15 cm)
465170	2.1 mm tip, 7-7/8" (20 cm)

ADSON DRESSING FORCEPS

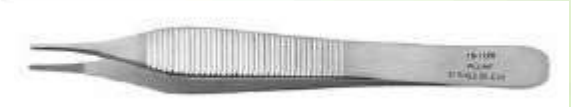

181220

. Pattern, satin finish.

Catalog #	Description
181220	4-3/4" (12 cm)

FORCEPS AND CLAMPS

Dressing Forceps

ADSON DRESSING FORCEPS



057200

Weck® Pattern, serrated tip.

Catalog #	Description
057200	Standard, 1.3 mm tip, 4-3/4" (12 cm)
057202	Delicate, 1.2 mm tip, 5" (12.5 cm)

ADSON DRESSING FORCEPS TC



057205

Weck® Pattern, tungsten carbide.

Catalog #	Description
057205	Standard, 4-3/4" (12 cm), TC

ADSON DRESSING FORCEPS



GS39060

Pattern.

Catalog #	Description
GS39058	Micro tip, serrated, 1 mm tip, 4-3/4" (12 cm)
GS39060	Delicate, serrated, 1.2 mm tip, 4-3/4" (12 cm)
GS39062	Standard tip, serrated, 4-3/4" (12 cm)
GS39059	Micro serrated, 1 mm tip, 6" (15 cm)
GS39052	Serrated, 1.2 mm tip, 6" (15 cm)

EWALD DRESSING FORCEPS



181237

. Pattern, satin finish. Delicate tips designed for careful handling of tissue. Handles are broad for comfortable, secure grasp.

Catalog #	Description
181237	Serrated, 4-3/4" (12 cm)

FORCEPS AND CLAMPS

Dressing Forceps

ADSON LASER TISSUE FORCEPS



Ebonized.

Catalog #	Description
447025	1 x 2 teeth, 4-3/4" (12 cm)

CUSHING DRESSING FORCEPS



Serrated handles, scraper end.

Catalog #	Description
181410	Straight, serrated tips, 7" (18 cm)

CUSHING DRESSING FORCEPS TC



Catalog #	Description
351860	Straight, 6-7/8" (17.5 cm), TC

CUSHING DRESSING FORCEPS



Weck® Pattern, bright finish.

Catalog #	Description
466200	Straight, serrated, 1.5 mm tip, 7" (18 cm)

CUSHING GUTSCH DRESSING FORCEPS

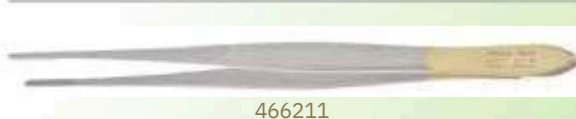

Tungsten carbide.

Catalog #	Description
466211	Serrated, 1.8 mm tip, 6-7/8" (17.5 cm), TC
466210	Serrated, 1.6 mm tip, 7" (18 cm), TC

FORCEPS AND CLAMPS

Dressing Forceps

CUSHING BAYONET DRESSING FORCEPS



Catalog #	Description
351861	7-1/2" (19 cm), TC

CUSHING GUTSCH BAYONET DRESSING FORCEPS



Serrated handles, scraper end.

Catalog #	Description
466220	Serrated, 1.5 mm tip, 7-1/4" (18.5 cm)

GERALD DRESSING FORCEPS



These are full-size dressing forceps with only the distal portion narrowed to provide light, delicate tips that maintain alignment.

Catalog #	Description
351900	Serrated, 7" (18 cm)
351902	Serrated, 9-3/4" (25 cm)

GERALD DRESSING FORCEPS TC



Catalog #	Description
466225	Straight, serrated, 1.1 mm tip, 6-7/8" (17.5 cm), TC

FORCEPS AND CLAMPS

Dressing Forceps

IRIS DRESSING FORCEPS



Catalog #	Description
181600	Straight, 4" (10 cm)
181602	Slightly curved, 4" (10 cm)

DRESSING FORCEPS



Catalog #	Description
GS38082	Curved, fine point serrated, 5" (12.5 cm)

GRUENWALD BAYONET FORCEPS



Catalog #	Description
466151	Serrated, 2.3 mm tip, 8-3/8" (21.5 cm)

FORCEPS AND CLAMPS

Dressing Forceps

JANSEN BAYONET DRESSING FORCEPS



466150

Catalog #	Description
GS55100	Serrated, 2.1 mm tip, 6-1/4" (16 cm)
466150	Serrated, 2.4 mm tip, 7-5/8" (19.5 cm)

LUCAE BAYONET DRESSING FORCEPS



027100

Catalog #	Description
027100	Delicate, 1.5 mm tip, 5-1/2" (14 cm)

LUCAE BAYONET DRESSING FORCEPS



031100

Catalog #	Description
031100	Serrated, 2 mm tip, 6-1/2" (16.5 cm)

THUMB BAYONET DRESSING FORCEPS



395118

Catalog #	Description
395118	Angled, smooth, 7-1/4" (18.5 cm)

FORCEPS AND CLAMPS

Dressing Forceps

NEVINS FORCEPS



Catalog #	Description
466160	Straight, 1.5 mm serrated tip, 6-3/4" (17 cm)

POTTS-SMITH DRESSING FORCEPS



Fine, serrated tips.

Catalog #	Description
351850	7-1/4" (18.5 cm)
351852	8-1/4" (21 cm)
351854	9-5/8" (24.5 cm)
351856	10-1/4" (26 cm)
351858	11-7/8" (30 cm)

POTTS-SMITH TECHNIQUE® DRESSING FORCEPS



Narrow, serrated, TC tips.

Catalog #	Description
351862	7" (18 cm), TC
351863	8" (20.5 cm), TC
351864	9-3/4" (25 cm), TC
351865	10-1/4" (26 cm), TC

FORCEPS AND CLAMPS

Dressing Forceps

BRIGHAM DRESSING FORCEPS



466170

Catalog #	Description
466170	Serrated, 1.7 mm dissecting tip, 6-1/8" (15.5 cm)

SEMKEN DRESSING FORCEPS



GS39086

Catalog #	Description
181270	Serrated, 5" (12.5 cm)
GS39086	Serrated, 1.8 mm tip, 6" (15 cm)

Tissue Forceps

THUMB TISSUE FORCEPS



181131

. Pattern, satin finish. 1 x 2 teeth.

Catalog #	Description
181127	2 mm tip, 5" (12.5 cm)
181129	2.6 mm tip, 5-1/2" (14 cm)
181131	2.4 mm tip, 6" (15 cm)
181133	3.3 mm tip, 7-1/4" (18.5 cm)
181139	3.4 mm tip, 11-3/4" (30 cm)

THUMB TISSUE FORCEPS



181166

. Pattern, satin finish.

Catalog #	Description
181155	1 x 2 teeth, extra-fine 2.6 mm tip, 5-1/2" (14 cm)
181166	2 x 3 teeth, 6-1/4" (16 cm)

FORCEPS AND CLAMPS

Tissue Forceps

TISSUE FORCEPS



Pattern, satin finish.

Catalog #	Description
GS38304	3 x 4 teeth, 5-1/2" (14 cm)



GS38304

THUMB TISSUE FORCEPS



Weck® Pattern, bright finish. 1 x 2 teeth.

467115

Catalog #	Description
467100	2.0 mm tip, 4-1/2" (11.5 cm)
467105	2.2 mm tip, 5" (12.5 cm)
467110	2.2 mm tip, 5-5/8" (14.5 cm)
467115	2.3 mm tip, 6-1/4" (16 cm)
467120	2.7 mm tip, 8" (20.5 cm)
467125	3.4 mm tip, 9-5/8" (24.5 cm)

TISSUE FORCEPS



. Pattern, satin finish.

181310

Catalog #	Description
181310	1.5 mm tip, 1 x 2 teeth, serrated, 6" (15 cm)

FORCEPS AND CLAMPS

Tissue Forceps

ADSON TISSUE FORCEPS



. Pattern, satin finish.



181228

Catalog #	Description
181223	1 x 2 teeth, 4-3/4" (12 cm)
181225	2 x 3 teeth, 5" (12.5 cm)
181228	1 x 2 teeth, serrated, 4-3/4" (12 cm)

ADSON TISSUE FORCEPS



Weck® Pattern, bright finish.



057207

Catalog #	Description
057207	1 x 2 teeth, 1.3 mm tip, 4-3/4" (12 cm)
057210	Standard, 1 x 2 teeth, 1.4 mm tip, 4-3/4" (12 cm)
057212	Delicate, 1 x 2 teeth, 1.2 mm tip, 5" (12.5 cm)
057214	Delicate, serrated, 1 x 2 teeth, 1.3 mm tip, 4-7/8" (12.5 cm)
057230	2 x 3 teeth, 2 mm tip, 5" (12.5 cm)



057210

FORCEPS AND CLAMPS

Tissue Forceps

CALLISON-ADSON TISSUE FORCEPS



057220

Weck® Pattern, bright finish.

Catalog #	Description
057220	1 x 2 teeth with tying platform, 1.3 mm tip, 4-3/4" (12 cm)

ADSON TISSUE FORCEPS



GS39057

Pattern, satin finish.

Catalog #	Description
GS39056	Micro 1 x 2 teeth, 0.8 mm tip, 4-3/4" (12 cm)
GS39057	Micro 1 x 2 teeth, 0.9 mm tip, 6" (15 cm)
GS39064	Delicate 1 x 2 teeth, 4-3/4" (12 cm)
GS39050	1 x 2 teeth, 1.2 mm tip, 6" (15 cm)

ADSON-DEBAKEY® TISSUE FORCEPS



GS39054

Pattern, satin finish. DeBakey® Teeth.

Catalog #	Description
GS39054	1.5 mm tip, 4-3/4" (12 cm)

BROWN-ADSON TISSUE FORCEPS



181235

. Pattern, satin finish. Delicate tips designed for careful handling of tissue. Handles are broad for comfortable, secure grasp.

Catalog #	Description
181235	9 x 9 teeth, 4-3/4" (12 cm)

BROWN-ADSON TISSUE FORCEPS



057250

Weck® Pattern, satin finish.

Catalog #	Description
057250	7 x 7 teeth, 2 mm tip, 4-3/4" (12 cm)

FORCEPS AND CLAMPS

Tissue Forceps

ADSON BROWN LASER TISSUE FORCEPS



Ebonized.

Catalog #	Description
447030	Straight, 9 x 9 teeth, 4-3/4" (12 cm)

EWALD TISSUE FORCEPS



. Pattern, satin finish. Delicate tips designed for careful handling of tissue. Handles are broad for comfortable, secure grasp.

Catalog #	Description
181240	1 x 2 teeth, 4-3/4" (12 cm)

HUDSON TISSUE FORCEPS



Catalog #	Description
057215	1 x 2 teeth, heavy, 1.5 mm tip, 5" (12.5 cm)

FORCEPS AND CLAMPS

Tissue Forceps

BEASLEY-BABCOCK TISSUE FORCEPS



Catalog #	Description
057302	6 x 6 teeth, 5-1/4" (13.5 cm)

BONNEY TISSUE FORCEPS



Strong, rugged construction. Serrated tying platform. Non-slip handles.

Catalog #	Description
640524	1 x 2 teeth, 3.3 mm tip, 6-3/4" (17 cm)
181327	2 x 3 teeth, 6-3/4" (17 cm)

BROWN TISSUE FORCEPS



Small 9 x 9 sets of teeth run longitudinally along narrow jaws.

Catalog #	Description
181255	6" (15 cm)
342965	8" (20.5 cm)
342967	9-1/2" (24 cm)

FORCEPS AND CLAMPS

Tissue Forceps

CUSHING BAYONET TISSUE FORCEPS



468240

Serrated handles, scraper end.

Catalog #	Description
468240	1 x 2 teeth, 7-1/4" (18.5 cm)

CUSHING GUTSCH TISSUE FORCEPS



468230

Catalog #	Description
468230	1 x 2 teeth, serrated, 7" (18 cm)

CUSHING TISSUE FORCEPS



468220

Catalog #	Description
468220	1 x 2 teeth, serrated, 7" (18 cm)



DEBAKEY® THORACIC TISSUE FORCEPS



342980



342986



The row of 1 x 2 DeBakey®-type serrations on the tips are designed to be large and strong enough to handle relatively large masses of tissue. Because of the groove construction and light spring tension, they may be used to hold and handle suture material as well. These forceps are of heavier design than the DeBakey® Vascular Tissue Forceps (351800 through 351814 on pg. 50). The distal portion is tapered to a 3 mm DeBakey®-type tip.

Catalog #	Description
342980	Straight, 3 mm tip, 6-1/8" (15.5 cm)
342981	Straight, 3 mm tip, 7-3/4" (19.5 cm)
342982	Straight, 3 mm tip, 9-1/2" (24 cm)
342984	Straight, 3 mm tip, 12" (30.5 cm)
342986	Angled, 3 mm tip, 12" (30.5 cm)

FORCEPS AND CLAMPS

Tissue Forceps

DEBAKEY® VASCULAR TISSUE FORCEPS



351800



351810

Standard. The distal 2 cm of these forceps is a narrow DeBakey®-type serration with a width of 2 mm. The body of the instrument is constructed especially to prevent feathering, and all pins and projections have been omitted to help eliminate suture catchers. Jaws are very well-fitted for handling tiny vessels as well as the smallest suture material.

Catalog #	Description
351800	Straight, 2 mm tip, 6" (15 cm)
351802	Straight, 2 mm tip, 7-3/4" (19.5 cm)
351804	Straight, 2 mm tip, 9-1/2" (24 cm)
351808	Straight, 2 mm tip, 12" (30.5 cm)
351810	Angled, 2 mm tip, 6" (15 cm)
351812	Angled, 2 mm tip, 7-3/4" (19.5 cm)
351814	Angled, 2 mm tip, 9-1/2" (24 cm)

DEBAKEY®-DIETRICH DELICATE VASCULAR TISSUE FORCEPS



351803

Designed for micro-vascular and coronary artery surgery. The distal portion is tapered to a 1 mm extra-fine DeBakey®-type serration.

Catalog #	Description
351801	Straight, delicate, 1 mm tip, 6" (15 cm)
351803	Straight, delicate, 1 mm tip, 7-3/4" (19.5 cm)
351806	Straight, delicate, 1 mm tip, 9-1/2" (24 cm)

DEBAKEY® ULTRALIGHT FORCEPS



351821

Approximately one-half the weight of standard DeBakey® Forceps, similar to that of titanium but at a much lower price. Ebonized stainless steel to reduce glare. Reduced tension minimizes fatigue and allows better control of delicate tissues.

Catalog #	Description
351820	1.5 mm tip, 6" (15 cm)
351821	1.5 mm tip, 7-3/4" (19.5 cm)

FORCEPS AND CLAMPS

Tissue Forceps

DEBAKEY® CARBIDE FORCEPS



DeBakey®-type serrations at distal tip. Tungsten carbide insert behind the jaw for secure needle pulling actions.



351817

Catalog #	Description
351815	Regular forceps, 6" (15 cm), TC
351817	Regular forceps, 7-3/4" (19.5 cm), TC
351818	Delicate forceps, 7-3/4" (19.5 cm), TC
351819	Regular forceps, 9-1/2" (24 cm), TC
351824	Delicate forceps, 9-1/2" (24 cm), TC



351818

VASCULAR DEBAKEY® BAYONET TISSUE FORCEPS



351845

DeBakey®-type serrations with a bayonet shape. Angled handles for difficult access and increased visibility.

Catalog #	Description
351845	Fine, 1.3 mm tip, 7-3/4" (19.5 cm)
351843	Standard, 2.0 mm tip, 7-3/4" (19.5 cm)



351843

FORCEPS AND CLAMPS

Tissue Forceps

DEBAKEY® TITANIUM TISSUE FORCEPS



Catalog#	Description
359024	Straight, flat handle, 1.5 mm jaw width, 6" (15 cm)
359025	Straight, flat handle, 1.5 mm jaw width, 7-5/8"(19.5cm)
359021	Straight, flat handle, 2.5 mm jaw width, 6" (15 cm)
359022	Straight, flat handle, 2.5 mm jaw width, 7-5/8"(19.5cm)
359027	Straight, flat handle, 3 mm jaw width, 6" (15 cm)
359028	Straight, flat handle, 3 mm jaw width, 7-5/8"(19.5cm)
359029	<u>Straight, flat handle, 3 mm jaw width, 9-1/2" (24 cm)</u>
359030	Angular, flat handle, 2.5 mm jaw width, 5-7/8"(15cm)
359031	Angular, flat handle, 2.5 mm jaw width, 7-1/2"(19cm)
359032	Angular, flat handle, 2.5 mm jaw width, 9-1/4"(23.5cm)

FERRISSMITH TISSUE FORCEPS



468190

Catalog#	Description
468190	2 x 3 teeth with 4 mm serrated tying platform. 6-7/8"(17.5cm)

GERALD TISSUE FORCEPS



351905

These are full-size tissue forceps with only the distal portion narrowed to provide light, delicate tips that maintain alignment.

Catalog#	Description
351905	1 x 2 teeth, 7" (18 cm)
351907	1x2teeth,9-3/4" (25cm)

FORCEPS AND CLAMPS

Tissue Forceps

GERALD DEBAKEY® TISSUE FORCEPS



351901

Delicate, tapered DeBakey®-type serrations.

Catalog #	Description
351901	7" (18 cm)
351908	8" (20.5 cm)
351909	9-1/2" (24 cm)
351910	Angled, 6-7/8" (17.5 cm)



351910

GRAEFE TISSUE FORCEPS



181250

Catalog #	Description
181250	5 x 6 teeth, 4-3/8" (11 cm)

FORCEPS AND CLAMPS

Tissue Forceps

IRIS TISSUE FORCEPS

Delicate.



Catalog #

Description

181610

Straight, 1 x 2 teeth, 4" (10 cm)

181614

Full curve, 1 x 2 teeth, 3-3/4" (9.5 cm)

181604

Full curve, 3-3/4" (9.5 cm)



181610



181614

SEMKEN TISSUE FORCEPS



181272

These delicate forceps are midway in size between Iris forceps and delicate standard tissue forceps.

Catalog #

Description

181272

1 x 2 teeth, 5" (12.5 cm)

GS39088

1 x 2 teeth, 6-1/4" (16 cm)

FORCEPS AND CLAMPS

Tissue Forceps

NELSON TISSUE FORCEPS



Catalog #
342950

Description
6 x 7 sharp, fine teeth, 9" (23 cm)

SINGLEY TISSUE FORCEPS



Serrated ring end 8.5 mm wide. Medium-heavy construction.

Catalog #
342933

Description
9" (23 cm)

ADAMS TISSUE FORCEPS



351835

Catalog #
351835

Description
Delicate, 1 mm tip, 8" (20.5 cm), TC

TUTTLE THORACIC TISSUE FORCEPS



342935

Light construction. Ring tips 6.8 mm wide.

Catalog #
342935

Description
9" (23 cm)

FORCEPS AND CLAMPS

Tissue Forceps

CORONARY ULTRA-FINE TISSUE FORCEPS



351838

Tungsten carbide.

Catalog #	Description
351837	7" (18 cm), TC
351838	8" (20.5 cm), TC
351839	9" (23 cm), TC

WHEELER TECHNIQUE® PLAQUE AND VESSEL FORCEPS



351827

Very powerful grip at tip.

Catalog #	Description
351825	DeBakey®-type jaw, 1.6 mm, 5-1/2" (14 cm)
351827	DeBakey®-type jaw, 1.6 mm, 7-1/8" (18 cm)
351829	DeBakey®-type jaw, 1.6 mm, 8-3/4" (22 cm)

CRAFOORD TISSUE FORCEPS



351898

Serrated tips are built up to provide an unusually secure grip.

Catalog #	Description
351898	Serrated, 8" (20.5 cm)

POTTS-SMITH TISSUE FORCEPS



351872

Fine, serrated, 1 x 2 distal teeth.

Catalog #	Description
351870	7-1/4" (18.5 cm)
351872	8-1/4" (21 cm)
351874	9-1/2" (24 cm)
351876	10-1/4" (26 cm)

FORCEPS AND CLAMPS

Tissue Forceps

RUSSIAN TISSUE FORCEPS



Catalog #	Description
181360	6" (15 cm)
181365	8" (20.5 cm)
181370	10" (25.5 cm)



181365

C.W. MAYO TISSUE FORCEPS



Russian-type fenestrated tips are 6.7 mm wide and deeply serrated.

342910

Catalog #	Description
342910	9" (23 cm)

DAVIS TISSUE FORCEPS



Russian-type jaws, 7.5 mm wide.

342915

Catalog #	Description
342915	Straight, serrated, 10" (25.5 cm)

SELMAN TISSUE FORCEPS



Small diameter circular tips have meshing teeth for secure, non-damaging grip.



351842

Catalog #	Description
351840	6" (15 cm)
351841	8" (20.5 cm)
351842	10" (25.5 cm)

FORCEPS AND CLAMPS

Hemostatic Forceps and Clamps

ADSON HEMOSTATIC FORCEPS



30 mm jaw, 2 mm tip, two-thirds serrations.

Catalog #	Description
477190	Straight, 7-1/2" (19 cm)
477191	Curved, 7-1/8" (18 cm)

THORACIC ARTERY FORCEPS



Slim, slightly curved jaws have very light criss-cross serrations making this an excellent instrument for handling suture material as well as delicate tissue.

Catalog #	Description
342585	Serrated, 2" (5 cm) tip length, 2 mm tip width, 9-1/4" (23.5 cm)

FORCEPS AND CLAMPS

Hemostatic Forceps and Clamps

LEJEUNE THORACIC FORCEPS



Catalog #
342594

Description
Slightly curved, serrated, 1-3/8" (3.5 cm) tip length,
1.8 mm tip width, 9-3/8" (24 cm)

BENGOLEA FORCEPS



Lightweight, with narrow, criss-cross serrated jaws.

Catalog #
342587

Description
Slightly curved, serrated, 2 mm wide tip,
8-1/2" (21.5 cm)

BRIDGE HEMOSTATIC FORCEPS



32 mm serrated jaw.

Catalog #
504180
504181
540111

Description
Straight, 2 mm tip, 11-1/8" (28.5 cm)
Curved, 2 mm tip, 11" (28 cm)
Curved, 1.6 mm tip, 6-7/8" (17.5 cm)

FORCEPS AND CLAMPS

Hemostatic Forceps and Clamps

CARMALT FORCEPS



Cross-serrated tip with longitudinally serrated jaw.

Catalog #	Description
476300	Straight, 43 mm jaw, 3 mm tip, 6-1/2" (16.5 cm)
476310	Straight, 58 mm jaw, 4 mm tip, 8-1/4" (21 cm)
476330	Curved, 43 mm jaw, 3 mm tip, 6-1/2" (16.5 cm)
476340	Curved, 58 mm jaw, 4 mm tip, 8-1/4" (21 cm)

FORCEPS AND CLAMPS

Hemostatic Forceps and Clamps

COLLER FORCEPS



475307



477110

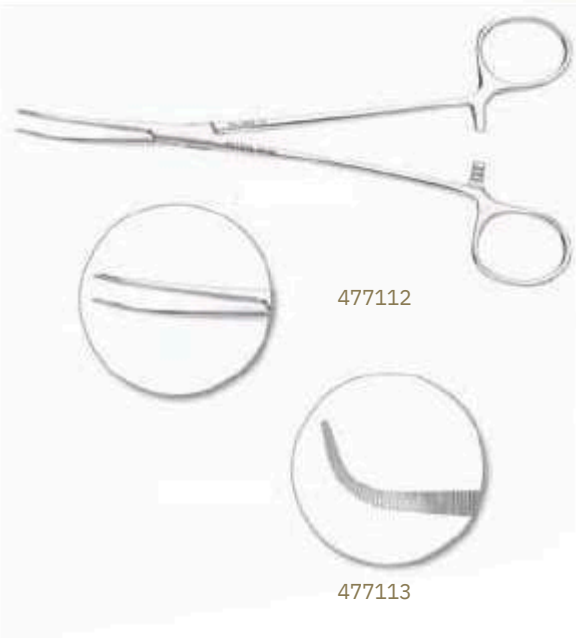

477112

477113

Catalog#	Description
475305	Skillman serrations, straight, 31 x 1.7 mm tip, 5-1/2" (14cm)
475306	Skillman serrations, curved, 29 x 1.7 mm tip, 5-3/8" (13.5cm)
475307	Skillman serrations, strongly curved, 26 x 1.7 mm tip, 5-3/8" (13.5 cm)
477109	Straight, 38 x 1.8 mm tip, 1 x 3 catch, 6-5/8" (17cm)
477110	Curved, 38 x 1.8 mm tip, 1 x 3 catch, 6-5/8" (17 cm)
477112	Curved, 42 x 1.7 mm tip, 1 x 3 catch, 7-1/4" (18.5 cm)
477113	Strongly curved, 37 x 1.6 mm tip, 1 x 3 catch, 7" (18 cm)
477116	Curved, 44 x 2 mm tip, 4 x 4 catch, 9-3/8" (24 cm)
477117	Strongly curved, 40 x 2 mm tip, 4 x 4 catch, 9-1/4" (23.5cm)
477118	Angled, 32 x 2 mm tip, 4 x 4 catch, 8-7/8" (22.5 cm)



477118

FORCEPS AND CLAMPS

Hemostatic Forceps and Clamps

COLLIER HEMOSTATIC FORCEPS



182086

A Crile-type forceps with a lighter distal end for more delicate procedures.

Catalog #	Description
182085	Straight, 5-1/2" (14 cm)
182086	Curved, 5-1/2" (14 cm)
182090	Straight, 6-1/4" (16 cm)
182095	Curved, 6-1/4" (16 cm)
182097	Straight, 7-3/4" (19.5 cm)
182098	Curved, 7-1/4" (18.5 cm)

CRILE HEMOSTATS



182060

. Pattern, satin finish, standard tip, full serrations.

Catalog #	Description
182050	Straight, 5-3/4" (14.5 cm)
182060	Curved, 5-1/2" (14 cm)
182070	Straight, 6-1/4" (16 cm)
182080	Curved, 6-1/4" (16 cm)

CRILE FORCEPS



475309

Weck® Pattern, bright finish, full serrations.

Catalog #	Description
475308	Straight, 5-5/8" (14.5 cm)
475309	Curved, 5-3/4" (14.5 cm)

FORCEPS AND CLAMPS

Hemostatic Forceps and Clamps

CRILE FORCEPS



475311

Weck® Pattern, bright finish, delicate, full serrations.

Catalog #	Description
475310	Straight, 1.8 mm tip, 5-1/2" (14 cm)
475311	Curved, 1.8 mm tip, 5-3/8" (13.5 cm)
475312	Straight, 1.7 mm tip, 6-3/8" (16 cm)
475313	Curved, 2 mm tip, 6-1/4" (16 cm)

DANDY HEMOSTATIC FORCEPS



181822

. Pattern, satin finish.

Catalog #	Description
181822	Curved sideways, 5-1/2" (14 cm)

DANDY KOLODNY FORCEPS

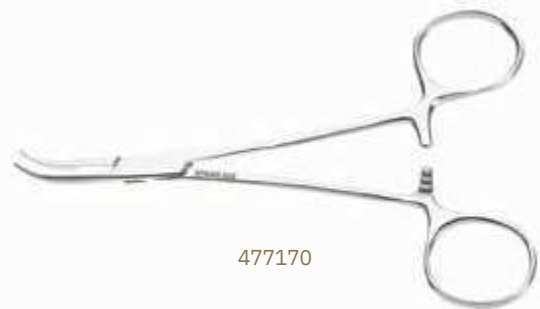

477170

Weck® Pattern, bright finish.

Catalog #	Description
477170	Curved sideways, one-half horizontal serrations, 5-3/8" (13.5 cm)

FORCEPS AND CLAMPS

Hemostatic Forceps and Clamps

HALSTED MOSQUITO FORCEPS



. Pattern, satin finish, full serrations.

Catalog #	Description
182300	Straight, 5-1/4" (13.5 cm)
182310	Curved, 5-1/8" (13 cm)
182350	Straight, 4" (10 cm)
182355	Curved, 4" (10 cm)

HALSTED MOSQUITO FORCEPS



Weck® Pattern, bright finish, serrated jaw.

Catalog #	Description
475084	Straight, 1.2 mm tip, 4-3/4" (12 cm)
475086	Curved, 1.2 mm tip, 4-5/8" (11.5 cm)
475100	Straight, 1.6 mm tip, 5-1/4" (13.5 cm)
475101	Curved, 1.6 mm tip, 5-1/8" (13 cm)

HALSTED MOSQUITO FORCEPS WITH TEETH



Weck® Pattern, bright finish.

Catalog #	Description
475102	Straight, 1 x 2 teeth, 1.5 mm tip, 5" (12.5 cm)

FORCEPS AND CLAMPS

Hemostatic Forceps and Clamps

HARTMANN MOSQUITO FORCEPS



Weck® Pattern, bright finish. Delicate, serrated jaw.

Catalog #	Description
475080	Straight, 20 mm jaw, 1.3 mm tip, 4" (10 cm)
475082	Curved, 20 mm jaw, 1.3 mm tip, 4" (10 cm)

MOSQUITO FORCEPS



Catalog #	Description
075118	Curved, fully serrated, 1.7 x 2 mm tip, 7-1/4" (18.5 cm)

FORCEPS AND CLAMPS

Hemostatic Forceps and Clamps

MOSQUITO FORCEPS SERRATED



Catalog #	Description
GS36078	Curved, serrated, 1 x 2 teeth, 5" (12.5 cm)

SKILLMAN MOSQUITO FORCEPS



Weck® Pattern, bright finish. Full serrations.

Catalog #	Description
475130	Straight, 1.6 mm tip, 5-1/4" (13.5 cm)
475131	Curved, 1.6 mm tip, 5-1/8" (13 cm)

FORCEPS AND CLAMPS

Hemostatic Forceps and Clamps

JONES HEMOSTAT



Sturdy construction, fully serrated.

Catalog #	Description
182160	Straight, 5" (12.5 cm)

KELLY FORCEPS



. Pattern, satin finish. Half serrations.

Catalog #	Description
182100	Straight, 5-3/4" (14.5 cm)
182110	Curved, 5-1/2" (14 cm)

KELLY FORCEPS



Weck® Pattern, bright finish. Half serrations.

Catalog #	Description
475210	Straight, 5-1/2" (14 cm)
475211	Curved, 5-1/2" (14 cm)

FORCEPS AND CLAMPS

Hemostatic Forceps and Clamps

LAHEY TRACTION FORCEPS



171155

Catalog #	Description
171155	Straight, 3 x 3 teeth, 6" (15 cm)

LAWRENCE HEMOSTATIC FORCEPS



504171

Catalog #	Description
504171	31 mm jaw, 2 mm tip, 10-3/4" (27.5 cm)
540140	30 mm jaw, 1.7 mm tip, 6-3/4" (17 cm)

MASTIN MUSCLE FORCEPS



550190

Catalog #	Description
550190	42 mm jaw with cross serrations on pin side only. Curved on side, 3.1 mm tip, 6-5/8" (17 cm)

FORCEPS AND CLAMPS

Hemostatic Forceps and Clamps

MAYO-PEAN FORCEPS



Weck® Pattern, bright finish. Straight hemostatic forceps with full serrations.

Catalog #	Description
476105	2.9 mm tip, 6-5/8" (17 cm)
476106	2.4 mm tip, 6-5/8" (17 cm)
476110	3.3 mm tip, 7-1/4" (18.5 cm)
476115	3.7 mm tip, 8-1/4" (21 cm)
476120	3.7 mm tip, 8-3/4" (22 cm)
476125	3.8 mm tip, 10-3/8" (26.5 cm)

MAYO-PEAN FORCEPS



Weck® Pattern, bright finish. Curved hemostatic forceps with full serrations.

Catalog #	Description
476150	2.5 mm tip, 5-5/8" (14.5 cm)
476155	2.9 mm tip, 6-1/2" (16.5 cm)
476156	2.4 mm tip, 6-1/2" (16.5 cm)
476160	3.3 mm tip, 7-1/8" (18 cm)
476165	3.7 mm tip, 8-1/4" (21 cm)
476170	3.5 mm tip, 9-1/4" (23.5 cm)
476175	3.8 mm tip, 10-1/4" (26 cm)

PEAN CLAMPS



Pattern, satin finish. Horizontal serrations.

Catalog #	Description
185060	Straight, 8-1/8" (20.5 cm)
185065	Curved, 8-1/8" (20.5 cm)
185066	Curved, 9-1/4" (23.5 cm)
185067	Straight, 10-1/8" (25.5 cm)

FORCEPS AND CLAMPS

Hemostatic Forceps and Clamps

ROCHESTER-PEAN FORCEPS



. Pattern, satin finish. Straight, full serrations.

Catalog #	Description
181830	Curved, 2 mm tip, 6-1/2" (16.5 cm)

ROCHESTER-PEAN FORCEPS



. Pattern, satin finish. Straight, full serrations.

Catalog #	Description
182400	2.7 mm tip, 5-1/2" (14 cm)
182405	2.8 mm tip, 6-1/2" (16.5 cm)
182415	3.0 mm tip, 7-1/4" (18.5 cm)
182420	3.2 mm tip, 8" (20.5 cm)

ROCHESTER-PEAN FORCEPS



. Pattern, satin finish. Curved, full serrations.

Catalog #	Description
182440	3.2 mm tip, 5-1/2" (14 cm)
182445	2.8 mm tip, 6-1/4" (16 cm)
182455	3.0 mm tip, 7-1/4" (18.5 cm)
182460	3.2 mm tip, 8" (20.5 cm)

FORCEPS AND CLAMPS

Hemostatic Forceps and Clamps

ROCHESTER-PEAN FORCEPS, 12"



GS36362

Pattern, satin finish.

Catalog #	Description
GS36360	Hemostatic, straight, 4.6 mm tip, 12" (30.5 cm)
GS36362	Curved, serrated, 12" (30.5 cm)

OCHSNER FORCEPS (KOCHER)



476205

Weck® Pattern, bright finish. Straight hemostatic forceps with full serrations, 1 x 2 teeth.

Catalog #	Description
476200	3 mm tip, 5-5/8" (14.5 cm)
476205	4.2 mm tip, 6-3/8" (16 cm)
476206	Light model, 2.5 mm tip, 6-3/8" (16 cm)
476210	3.3 mm tip, 7-1/4" (18.5 cm)
476215	4.5 mm tip, 8" (20.5 cm)
476220	5.5 mm tip, 8-7/8" (22.5 cm)
476225	5 mm tip, 10-3/8" (26.5 cm)

OCHSNER FORCEPS (KOCHER)



476255

Weck® Pattern, bright finish. Curved hemostatic forceps with full serrations, 1 x 2 teeth.

Catalog #	Description
476250	2.7 mm tip, 5-1/2" (14 cm)
476255	2.6 mm tip, 6-1/4" (16 cm)
476260	3.6 mm tip, 7-1/4" (18.5 cm)
476265	3.4 mm tip, 7-7/8" (20 cm)
476270	4 mm tip, 8-3/4" (22 cm)
476275	4 mm tip, 10-1/4" (26 cm)

FORCEPS AND CLAMPS

Hemostatic Forceps and Clamps

ROCHESTER-OCHSNER FORCEPS (KOCHER)



. Pattern, straight. Full serrations, 1 x 2 teeth.

Catalog #	Description
182600	5-1/2" (14 cm)
182605	6-1/4" (16 cm)
182615	7-1/4" (18.5 cm)
182620	8" (20.5 cm)

ROCHESTER-OCHSNER FORCEPS (KOCHER)



. Pattern, curved. Full serrations, 1 x 2 teeth.

Catalog #	Description
182655	6-1/4" (16 cm)
182665	7-1/4" (18.5 cm)
182670	Curved, 1 x 2 teeth, 8" (20.5 cm)

PROVIDENCE HOSPITAL FORCEPS



Weck® Pattern, bright finish. Two-thirds serrations.

Catalog #	Description
475200	Straight, 2 mm tip, 5-3/8" (13.5 cm)
475201	Curved, 2 mm tip, 5-3/8" (13.5 cm)

FORCEPS AND CLAMPS

Hemostatic Forceps and Clamps

PROVIDENCE HOSPITAL HEMOSTATS



. Pattern, satin finish. Half serrations.

Catalog #	Description
182140	Straight, 5-3/4" (14.5 cm)
182150	Curved, 5-5/8" (14.5 cm)

RANKIN FORCEPS



. Pattern, satin finish. Half serrations.

Catalog #	Description
182120	Straight, 6-1/4" (16 cm)
182130	Curved, 6-1/4" (16 cm)

RANKIN-KELLY HEMOSTAT FORCEPS



Pattern, satin finish. Three-quarter serrations.

Catalog #	Description
GS36196	Straight, 6-1/4" (16 cm)
GS36198	Curved, serrated, 6-1/4" (16 cm)

FORCEPS AND CLAMPS

Hemostatic Forceps and Clamps

SAROT INTRA-THORACIC ARTERY FORCEPS



Slender, slightly curved forceps with serrated jaws. Specially designed for pulmonary resections, cardiovascular and esophageal surgery.

Catalog #	Description
342571	Medium, serrated, 1/2" (1.5 cm) tip length, 1.6 mm tip width, 7-5/8" (19.5 cm)
342572	Large, serrated, 2-1/4" (5.5 cm) tip length, 2 mm tip width, 9" (23 cm)

SCHNIDT FORCEPS (TONSIL)



. Pattern, satin finish. Half serrations.

Catalog #	Description
182390	Half curved, 7-1/2" (19 cm)

SCHNIDT FORCEPS (TONSIL)



Weck® Pattern, bright finish.

Catalog #	Description
075116	Slightly curved, 7-1/4" (18.5 cm)
075120	Lightly curved, serrated, 2 mm tip, 7-1/2" (19 cm)
075122	Strongly curved, serrated, 2 mm tip, 7-1/2" (19 cm)

FORCEPS AND CLAMPS

Hemostatic Forceps and Clamps

VANDERBILT VESSEL FORCEPS



342590

This hemostatic-type forceps is particularly useful in cardiovascular and thoracic surgery but has been used extensively in general surgery as well. The elongated handles afford access to a number of surgical sites. Jaws are of a standard cross-serration design.

Catalog #	Description
342590	Slightly curved, 2" (5 cm) tip length, 2 mm tip width, 8-5/8" (22 cm)

SERREFINES CROSS-ACTION CLAMPS



182205

Catalog #	Description
182200	Straight, 1-1/2" (4 cm)
182205	Straight, 2-1/4" (5.5 cm)
182210	Curved, 1-3/8" (3.5 cm)

Extra-Delicate Hemostatic Forceps

JACOBSON HEMOSTATIC FORCEPS



443507

. Pattern, satin finish. These delicate forceps feature tips as fine as 0.8 mm and can be used in a number of microsurgical procedures.

Catalog #	Description
443500	Straight, 0.8 mm tip, 3-7/8" (10 cm)
443502	Curved, 0.8 mm tip, 3-7/8" (10 cm)
443505	Straight, 0.8 mm tip, 5-1/8" (13 cm)
443507	Curved, 0.8 mm tip, 5-1/8" (13 cm)
443508	Full curved, 0.8 mm tip, 4-7/8" (12.5 cm)
443510	Curved, 1.2 mm tip, 7-1/8" (18 cm)
443512	Full curved, 1 mm tip, 7-1/8" (18 cm)

FORCEPS AND CLAMPS

Extra Delicate Hemostatic Forceps

MICRO MOSQUITO FORCEPS



GS36165

Pattern, satin finish.

Catalog #	Description
GS36164	Straight, 1 mm tip, 5" (12.5 cm)
GS36165	Curved, serrated, extremely fine tips, 5" (12.5 cm)

PLASTI STATS® ADSON FORCEPS



181824

Catalog #	Description
181824	Curved, 1/2" (12.5 mm) jaw serration, 5-1/2"(14 cm)

PLASTI STATS® COLLIER FORCEPS



181804

Catalog #	Description
181804	Curved, 7-1/2" (19 cm)

FORCEPS AND CLAMPS

Extra Delicate Hemostatic Forceps

PLASTISTATS CRILEHEMOSTATS



181802

Full serrations.

Catalog #	Description
181800	Straight, 1-1/4" (32 mm) jaw, 5-3/4" (14.5 cm)
181802	Curved, 1-1/4" (32 mm) jaw, 5-1/2" (14 cm)

PLASTI STATS® KOCHER FORCEPS



181832

Catalog #	Description
181832	Straight, 1 x 2 teeth, full serrations, 5-1/2" (14 cm)

PLASTI STATS® MOSQUITO FORCEPS



181806

Full serrations.

Catalog #	Description
181810	Straight, 3/4" (2 cm) jaw, 4" (10 cm)
181812	Curved, 5/8" (1.5 cm) jaw, 4" (10 cm)
181818	Straight, 1/2" (12.5 mm) jaw, 4-3/4" (12 cm)
181820	Curved, 1/2" (12.5 mm) jaw, 4-5/8" (11.5 cm)
181814	Straight, 3/4" (2 cm) jaw, 5" (12.5 cm)
181816	Curved, 3/4" (2 cm) jaw, 5" (12.5 cm)
181806	Straight, 1" (2.5 cm) jaw, 5-1/2" (14 cm)
181808	Curved, 1" (2.5 cm) jaw, 5-1/2" (14 cm)

FORCEPS AND CLAMPS

Right Angle Clamps

CROUCH CLAMP

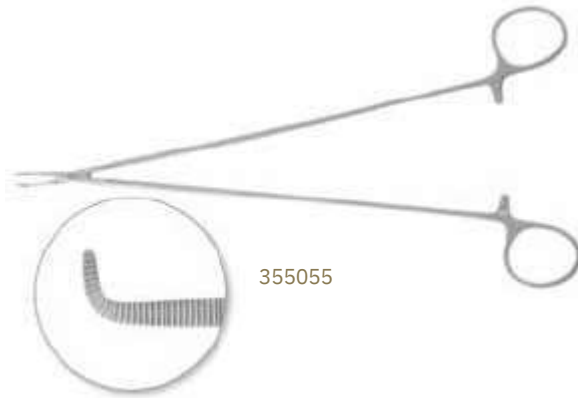

Catalog #	Description
355055	10-1/4" (26 cm)

DEBAKEY® RIGHT ANGLE FORCEPS



With full length longitudinal serrations and cross serrations at tip.

Catalog #	Description
342566	7-5/8" (19.5 cm)
342567	9" (23 cm)
342568	10-1/4" (26 cm)
342569	11-3/8" (29 cm)

FORCEPS AND CLAMPS

Right Angle Clamps

DIETHRICH RIGHT ANGLE CLAMPS



Catalog #

355798

355799

355800

355801

Description

Serrated jaw, 5-3/8" (13.5 cm)

Serrated jaw, 4-7/8" (12.5 cm)

Serrated jaw 8 mm past angle, 7-1/4" (18.5 cm)

Longitudinally serrated jaw 8 mm past angle, 7-1/4" (18.5 cm)



355800



355801

FINOCHIETTO THORACIC FORCEPS



A utility clamp for use as ligature carrier, hemostat or dissector. Particularly good in ligation during esophageal surgery. Blades have longitudinal serrations and holes for threading ligature.

Catalog #

342615

Description

Angled, longitudinal serrations, 1-1/8" (3 cm) tip length, 9-1/2" (24 cm)

FORCEPS AND CLAMPS

Right Angle Clamps

GEMINI FORCEPS



A more delicate modification of the Mixer Forceps. Slender, acutely curved jaws with full serrations.

Catalog #	Description
342596	7-1/4" (18.5 cm)
342597	9" (23 cm)
342598	11-1/8" (28.5 cm)

GRAY CYSTIC DUCT FORCEPS



Catalog #	Description
172550	Curved jaws and shafts. Set of two: 8-1/4" (21 cm) and 9-1/4" (23.5 cm)

HARRINGTON CLAMPS



Right angle jaw. Dull, non-glare finish stainless steel.

Catalog #	Description
342632	Heavy construction, longitudinal serrations, 1-1/2" (4 cm) tip length, 12-3/8" (31.5 cm)
342633	Light construction, longitudinal serrations, 1-1/2" (4 cm) tip length, 12-3/8" (31.5 cm)

FORCEPS AND CLAMPS

Right Angle Clamps

JACKSON TRACHEAL HEMOSTAT



514480

Catalog #	Description
514480	Acutely curved, 5-3/8" (13.5 cm)

KANTROWITZ FORCEPS



342557

True right angle forceps with cross serrated jaws. Useful for grasping and dissecting in thoracic, vascular and general surgery.

Catalog #	Description
342557	Serrated, 3/4" (2 cm) tip length, 2 mm tip width, 7-7/8" (20 cm)
342558	Serrated, 9-1/2" (24 cm)
342559	Serrated, 3/4" (2 cm) tip length, 2 mm tip width, 10-5/8" (27 cm)

FORCEPS AND CLAMPS

Right Angle Clamps

LAHEY DISSECTING FORCEPS



Catalog #
496105
496110
496111

Description
Longitudinal serrations, 2.4 mm tip, 7-7/8" (20 cm)
Horizontal serrations, 44 mm jaw, 2.4 mm tip,
7-3/4" (19.5 cm)
Longitudinal serrations, 46 mm jaw, 2.5 mm tip,
7-3/4" (19.5 cm)

LAHEY GALL DUCT FORCEPS, SLENDER BLADES



Catalog #
172530
172531
172532

Description
Longitudinal serrations, 7-1/2" (19 cm)
Standard serrations, 7-1/2" (19 cm)
Longitudinal serrations, 8-7/8" (22.5 cm)

FORCEPS AND CLAMPS

Right Angle Clamps

LOWER GALL DUCT FORCEPS



Catalog #
172525

Description
Short jaws, fully curved, longitudinal serrations,
7-1/2" (19 cm)

172525

MEEKER HEMOSTATIC DISSECTING FORCEPS



Catalog #
540150
504190

Description
90 degree-angled, serrated, 23 mm jaw, 1.8 mm tip,
6-3/8" (16 cm)
90 degree-angled, serrated, 28 mm jaw, 1.8 mm tip,
10-5/8" (27 cm)

504190

MACQUIGG-MIXTER FORCEPS



An excellent general purpose forceps and bronchus clamp. Longitudinally serrated jaws, right angle tip.

Catalog #
342611

Description
Curved, longitudinal serrations, 1-5/8" (4 cm) tip
length, 8-5/8" (22 cm)

342611

FORCEPS AND CLAMPS

Right Angle Clamps

MIXTER THORACIC FORCEPS



Regular model. Available with DeBakey®-type jaw or standard serrated jaw, 3/4" (2 cm) long.

Catalog #	Description
342603	Half curved, serrated, 5/8" (1.5 cm) tip length, 2.3 mm tip width, 9-1/8" (23 cm)
342600	Curved, DeBakey®-type jaw, 1" (2.5 cm) tip length, 2.8 mm tip width, 9-1/4" (23.5 cm)
342601	Strongly curved, serrated, 3/4" (2 cm) tip length, 8-3/4" (22 cm)

MIXTER CLAMPS



Catalog #	Description
477108	40 degree-angled, fully serrated, 50 mm jaw, 3 mm tip, 7-3/4" (19.5 cm)

MIXTER DISSECTING FORCEPS



Two-thirds serrations.

Catalog #	Description
477091	26 mm jaw, 2 mm tip, 7-1/4" (18.5 cm)
477092	40 mm jaw, 2.2 mm tip, 9" (23 cm)
477093	55 mm jaw, 2.4 mm tip, 11" (28 cm)

477092

FORCEPS AND CLAMPS

Right Angle Clamps

MIXTER FORCEPS



GS36566

Catalog #	Description
GS36566	Fully curved, serrated, 9" (23 cm)

MIXTER GALL DUCT FORCEPS



172503

Acutely curved jaws. Full serrations run entire length of jaw.

Catalog #	Description
172500	6-1/4" (16 cm)
172503	7-1/8" (18 cm)
172506	8-3/4" (22 cm)

PEDIATRIC MIXTER DISSECTING FORCEPS



477090

Weck® Pattern, bright finish, fully curved.

Catalog #	Description
477090	24 mm jaw, 2 mm tip, 5-1/4" (13.5 cm)

FORCEPS AND CLAMPS

Right Angle Clamps

MIXTER "PEDI" GALL DUCT FORCEPS



. Pattern, satin finish.

Catalog #	Description
172495	Delicate, 5-1/8" (13 cm)

RIENHOFF SWAN-NECK CLAMP



A double-curved forceps with delicately rounded tips.

Catalog #	Description
342625	Serrated, 10-5/8" (27 cm)

ROOS SCALENECTOMY FORCEPS



Designed to give a secure hold on the scalene muscle during scaleneotomy.

Catalog #	Description
342575	Right angle, longitudinal serrations, 1/2" (1.5 cm) tip length, 1.5 mm tip width, 11" (28 cm)

FORCEPS AND CLAMPS

Right Angle Clamps

RUMEL THORACIC FORCEPS



342511

Furnished with DeBakey®-type jaw or standard serrated jaws. In addition to being one of the more popular thoracic artery forceps, they are especially suited for passing tapes around the cava or pulmonary artery in open heart surgery.

Catalog #	Description
342501	A curved, DeBakey® jaw, 2-3/4" (7 cm) tip length, 9-5/8" (24.5 cm)
342504	D curved, DeBakey® jaw, 1-1/8" (3 cm) tip length, 2.8 mm tip width, 9-3/4" (25 cm)
342511	A curved, serrated, 1/2" (1.5 cm) tip length, 2.4 mm tip width, 9-3/8" (24 cm)
342513	C curved, serrated, 3/4" (2 cm) tip length, 2 mm tip width, 9-5/8" (24.5 cm)
342514	D curved, serrated, 1" (2.5 cm) tip length, 2.4 mm tip width, 9" (23 cm)
342533	Child size, fully curved, standard serrated, 2 mm tip width, 7-7/8" (20 cm)



342533



342501

SAWTELL HEMOSTATIC FORCEPS



342583

Catalog #	Description
342583	Full curved, heavy tips, 7-1/4" (18.5 cm)

FORCEPS AND CLAMPS

Right Angle Clamps

STOREY HEMOSTATIC FORCEPS



33 mm jaw with cross serrations.

Catalog #	Description
496215	Slightly curved, 8-3/4" (22 cm)
496216	Strongly curved, 8-5/8" (22 cm)
496217	Right angle, 8-3/8" (21.5 cm)

WESTPHAL DISSECTING FORCEPS



Longitudinal serrations, narrow tip.

Catalog #	Description
496112	Angled, 7-7/8" (20 cm)

FORCEPS AND CLAMPS

Right Angle Clamps

WILLAUER FORCEPS



Catalog # 342580 Lightweight full curved, longitudinally serrated jaws.

Description
2" (5 cm) tip length, 9-1/2" (24 cm)

Gastrointestinal Forceps and Clamps

ADAIR-ALLIS INTESTINAL TISSUE FORCEPS



Catalog # 182915

Description
9 x 10 teeth, 6-1/4" (16 cm)

ALLEN INTESTINAL CLAMPS



Longitudinal serrations, 1 x 2 teeth.

Catalog #	Description
185005	Jaws 3-3/4" (9.5 cm), 9-1/2" (24 cm)
185006	Jaws 2-3/8" (6 cm), 8" (20.5 cm)
185010	Pediatric size, delicate, jaws 2-1/8" (5.5 cm), 6-1/4" (16 cm)

FORCEPS AND CLAMPS

Gastrointestinal Forceps and Clamps

ALLIS DELICATE TISSUE FORCEPS



Weck® Pattern, bright finish, 6-1/8" (15.5 cm).

Catalog #	Description
541100	2 x 3 teeth , 3.8 mm tip
541120	Straight, delicate, 3 x 4 teeth , 4 mm tip

ALLIS TISSUE FORCEPS



. Pattern, satin finish.

Catalog #	Description
182795	3 x 4 teeth, 6" (15 cm)
182850	4 x 5 teeth, 6" (15 cm)
182860	5 x 6 teeth, 6" (15 cm)
182870	5 x 6 teeth, 7-1/2" (19 cm)
182875	5 x 6 teeth, 9" (23 cm)
182880	4 x 5 teeth, 5-3/4" (14.5 cm)

ALLIS TISSUE FORCEPS



Weck® Pattern, bright finish.

Catalog #	Description
541094	3 x 4 teeth, 5" (12.5 cm)
500310	4 teeth, 6-1/8" (15.5 cm)
500311	5 teeth, 6-1/8" (15.5 cm)
500312	6 teeth, 6-1/8" (15.5 cm)
500316	6 teeth, 7-1/2" (19 cm)

FORCEPS AND CLAMPS

Gastrointestinal Forceps and Clamps

JUDD-ALLIS INTESTINAL FORCEPS



Catalog #	Description
182900	3 x 4 teeth, 6" (15 cm)
182905	3 x 4 teeth, 7-1/4" (18.5 cm)

LOCKWOOD-ALLIS INTESTINAL TISSUE FORCEPS



Catalog #	Description
182920	Light model, flattened jaws, 5 x 6 teeth, 6-1/4" (16 cm)

THOMS-ALLIS TISSUE AND TRACTION FORCEPS



Catalog #	Description
182910	6 x 7 teeth, 8" (20.5 cm)

FORCEPS AND CLAMPS

Gastrointestinal Forceps and Clamps

WILLAUER-ALLIS TISSUE FORCEPS



Extra-long, springy, Allis-type forceps with 5 x 6 teeth.
Dull, non-glare finish stainless steel.

Catalog #	Description
342720	10" (25.5 cm)
342721	11-1/4" (28.5 cm)

BABCOCK TISSUE FORCEPS



. Pattern, satin finish.

Catalog #	Description
183010	6-1/4" (16 cm)
183020	7-7/8" (20 cm)
342725	Serrated, 9-1/2" (24 cm)
342726	Serrated, 9-1/2" (24 cm)

BABCOCK TISSUE FORCEPS



Weck® Pattern, bright finish.

Catalog #	Description
500399	5.8 mm tip, 5-3/4" (14.5 cm)
500400	8.3 mm tip, 6-3/8" (16 cm)
500402	10 mm tip, 7-7/8" (20 cm)

FORCEPS AND CLAMPS

Gastrointestinal Forceps and Clamps

BABCOCK TISSUE FORCEPS



500412

Tungsten carbide jaw tips.

Catalog #	Description
500410	3/8" (9.5 mm) tip, 6-1/2" (16.5 cm), TC
500412	7/16" (11 mm) tip, 7-7/8" (20 cm), TC

BAINBRIDGE FORCEPS

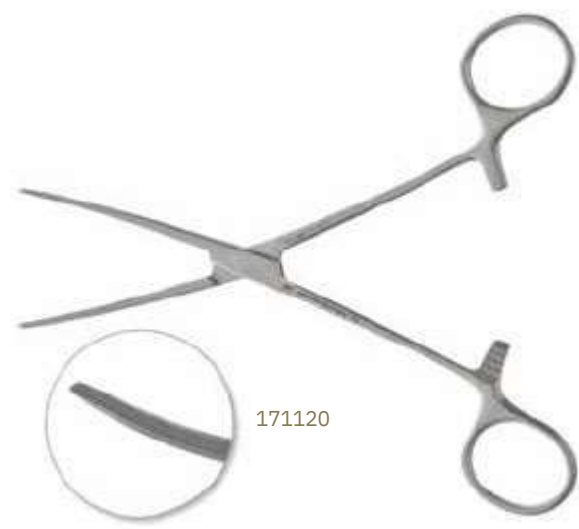

171120

. Pattern, satin finish. Slender blades longitudinally serrated.

Catalog #	Description
171117	Straight, 7-1/4" (18.5 cm)
171120	Curved, 6-3/4" (17 cm)
171122	Curved, 7-1/4" (18.5 cm)

FORCEPS AND CLAMPS

Gastrointestinal Forceps and Clamps

DEBAKEY® BAINBRIDGE CLAMPS



With narrow DeBakey®-type jaws.

Catalog #	Description
353560	Straight, 40 x 2.4 mm jaws, 7" (18 cm)
353562	Straight, 80 x 2.8 mm jaws, 7-7/8" (20 cm)
353565	Curved, 60 x 2.4 mm jaws, 7" (18 cm)

BEST COLON CLAMP

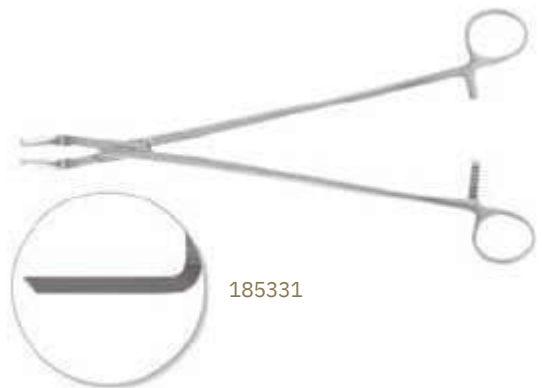

Right angle design for open anastomosis. Strong crushing jaws.

Catalog #	Description
185331	2-5/8" (6.5 cm) jaw size, 10-5/8" (27 cm)

FORCEPS AND CLAMPS

Gastrointestinal Forceps and Clamps

BLAKE GALLSTONE GRASPING FORCEPS



. Pattern, satin finish.

Catalog #	Description
172616	Curved, serrated, 8" (20.5 cm)

CYSTIC DUCT CATHETER CLAMPS



For open cholangiography.

Catalog #	Description
172570	Accepts 4 Fr. catheter, 7-1/2" (19 cm)
172571	Accepts 6 Fr. catheter, 7-1/2" (19 cm)

FORCEPS AND CLAMPS

Gastrointestinal Forceps and Clamps

DEBAKEY® THORACIC DISSECTING FORCEPS



DeBakey®-type jaws. The jaws are narrowed and thinned to a minimum size and double-curved. This provides a lightweight, sure-holding forceps for dissecting and passing tapes and ligatures around vessels.

Catalog #	Description
342560	C curved, 3/8" (1 cm) tip length, 8-1/8" (20.5 cm)
342561	D curved, 1/2" (1.5 cm) tip length, 2.8 mm tip width, 8-1/4" (21 cm)
342562	C curved, 5/8" (1.5 cm) tip length, 2.8 mm tip width, 9-5/8" (24.5 cm)
342563	D curved, 7/8" (2 cm) tip length, 9-1/2" (24 cm)
342565	D curved, 3/4" (2 cm) tip length, 10-1/4" (26 cm)



342560



342561



342562



342563



342565

FORCEPS AND CLAMPS

Gastrointestinal Forceps and Clamps

DENNIS ANASTOMOSIS CLAMP



Catalog #
185030

Description
54 mm jaws, 9-1/4" (23.5 cm)

DESJARDIN GALLSTONE GRASPING FORCEPS



Catalog #
172625

Description
9-1/4" (23.5 cm)

DOYEN INTESTINAL CLAMPS



Soft blades, diagonal serrations.

Catalog #	Description
185202	Straight, 9-1/8" (23 cm)
185204	Curved, 9" (23 cm)

FORCEPS AND CLAMPS

Gastrointestinal Forceps and Clamps

HAYES ANTERIOR RESECTION CLAMPS



70 degree-angled, 1 x 2 DeBakey® Jaws, angular shafts.

Catalog #	Description
183975	2-3/8" (6 cm) jaws, 9-7/8" (25 cm)
183977	3-1/8" (8 cm) jaws, 10-1/2" (26.5 cm)

KLINTMALM™ LIVER TRANSPLANT CLAMPS

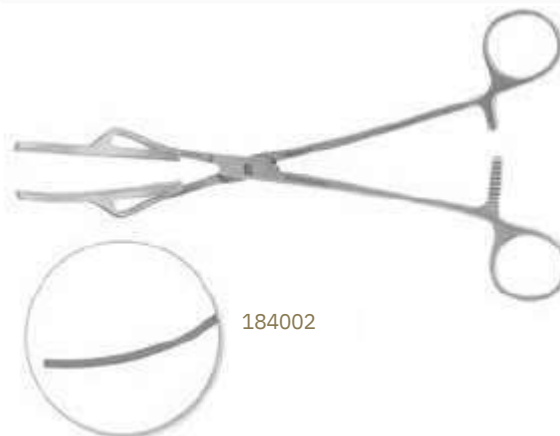

The KLINTMALM™ Liver Transplant Clamp is designed to securely occlude the suprahepatic inferior vena cava of the recipient during anastomosis of the donor liver.

- Unique "teething" design of a single row against a double row of teeth helps prevent slippage and scissoring of the jaw.
- An even-parallel closure of the jaw helps prevent blood seepage and helps minimize the risk of the vena cava slipping from the clamp.
- Jaw curvature is designed to meet the anatomical requirements of the upper abdomen and to reduce trauma to the liver.

A standard vascular clamp on the cuff of the vena cava and diaphragm may not always properly close due to the amount of tissue in the clamp. The use of a standard vascular clamp may result in clamp insecurity and slippage leading to the possible retraction of the vena cava into the diaphragm, and visual obstruction caused by pooling blood.

Catalog #	Description
184001	Small 2-1/2" (6.5 cm) jaw, 7-1/8" (18 cm)
184002	Medium 3-1/8" (8 cm) jaw, 8-3/8" (21.5 cm)
184003	Large 3-3/8" (8.5 cm) jaw, 9-7/8" (25 cm)

FORCEPS AND CLAMPS

Gastrointestinal Forceps and Clamps

KOCHER INTESTINAL CLAMPS



Soft blades, longitudinal serrations.

Catalog #	Description
185210	Straight, 10" (25.5 cm)
185212	Curved, 9-7/8" (25 cm)
185214	Straight, 10-3/4" (27.5 cm)

LELAND JONES CLAMPS

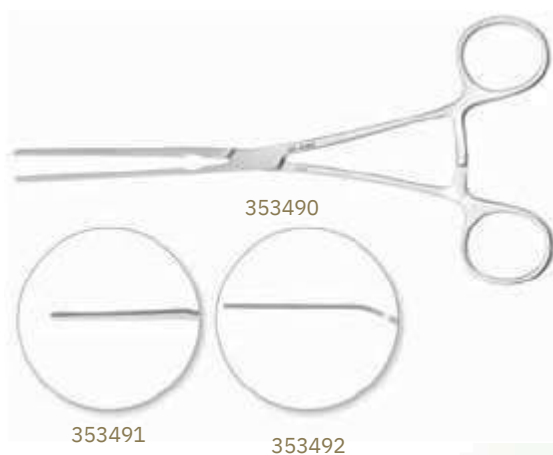

Delicate DeBakey® Jaws, 2.4 mm wide. LIFE-LOK® Box-Lock. Versatile clamps which have been found useful in small bowel procedures.

Catalog #	Description
353490	Straight, 8-1/8" (20.5 cm)
353491	Angled 15 degrees, 8-1/8" (20.5 cm)
353492	Angled 30 degrees, 8" (20.5 cm)

MIXTER FORCEPS



Long model. Very useful for deep dissection and as a bronchus clamp.

Catalog #	Description
342606	Strongly curved, serrated (3 cm) tip length, 10-3/4" (27.5 cm)
342605	Strongly curved, DeBakey® Jaw, 1-3/8" (3.5 cm) tip length, 11" (28 cm)

FORCEPS AND CLAMPS

Gastrointestinal Forceps and Clamps

MAYO (GUYON) VESSEL CLAMP

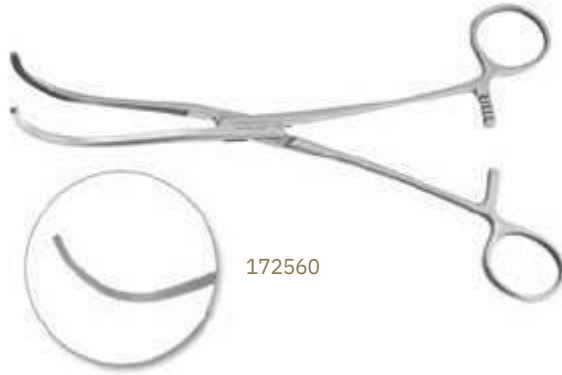

Catalog #	Description
172560	9-1/4" (23.5 cm)

MAYO-ROBSON INTESTINAL CLAMPS

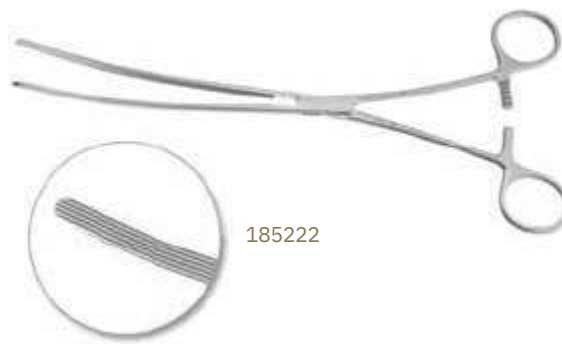

Longitudinal serrations.

Catalog #	Description
185220	Straight, 10-1/4" (26 cm)
185222	Curved, 10" (25.5 cm)

FORCEPS AND CLAMPS

Gastrointestinal Forceps and Clamps

PENNINGTON FORCEPS



Catalog #	Description
475250	Serrated, triangular, 14 x 11 mm jaw, 6-1/8" (15.5 cm)
616370	Serrated, triangular, 16 x 12.5 mm jaw, 8-1/4" (21 cm)

GUT AND COLON CLAMPS

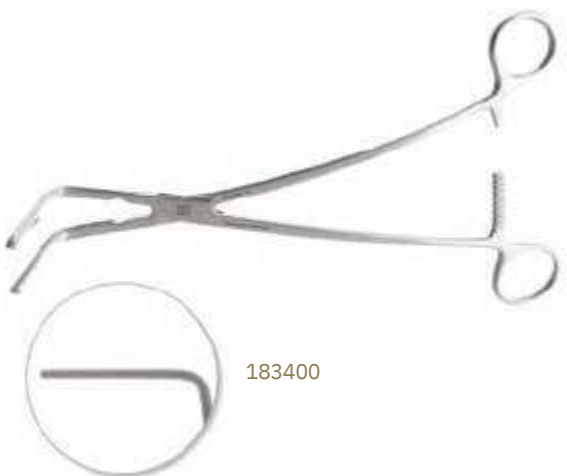

90 degree angled, 1 x 2 DeBakey®-type jaws,
curved shafts.

Catalog #	Description
183400	2-3/4" (7 cm) jaws, 9-3/8" (24 cm)
183410	3-5/8" (9 cm) jaws, 9-5/8" (24.5 cm)

FORCEPS AND CLAMPS

Gastrointestinal Forceps and Clamps

STONE INTESTINAL CLAMPS



Handle may be used at any angle. Narrow longitudinally serrated blades. Set consists of 2 clamps with tip locks and 2 applying forceps.

Catalog #	Description
185402	Set. With 4-3/8" (11 cm) length clamps
185404	Clamp with tip lock, 3-3/8" (8.5 cm)



STRELINGER RIGHT ANGLE CLAMP

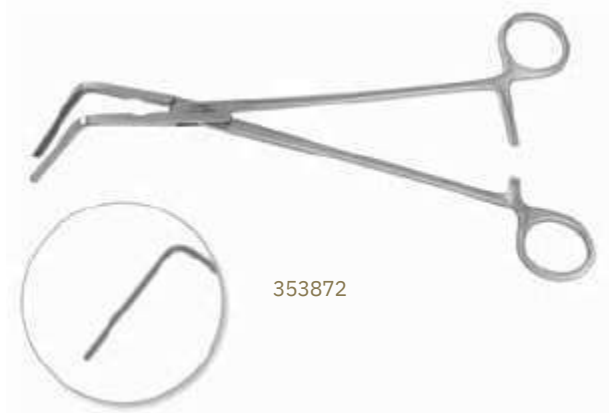

Catalog #	Description
353872	Large size, 3-1/4" (8.5 cm) DeBaKey®-type jaws angled 90 degrees, 9-5/8" (24.5 cm)

KNIFE HANDLES

KNIFE HANDLES

General

KNIFE HANDLES



352950



352951



352952



352953



352954



352957



352959

Correctly fit knife handle to standard surgical blades. The distal ends are tapered and beveled for use in blunt dissection. Each handle is contoured for firm grip, strength, manipulation and comfort. They are sold one handle each per package.

Catalog #	Description
352950	Size 3, fits blade sizes 10, 11, 12 and 15
352951	Size 3L, fits blade sizes 10, 11, 12 and 15. Measures 8-3/8" (21.5 cm) not including blade.
352952	Size 3LA, fits blade sizes 10, 11, 12 and 15
352953	Size 4, fits blade sizes 20, 21, 22, 23, 24 and 25
352954	Size 4L, fits blade sizes 20, 21, 22, 23, 24 and 25. Measures 8-3/8" (21.5 cm) not including blade.
352957	Size 7, fits blade sizes 10, 11, 12 and 15
352959	Size 9, fits blade sizes 10, 11, 12 and 15

KNIFE HANDLES

General

ROUND SHAFT BEAVER BLADE HANDLES

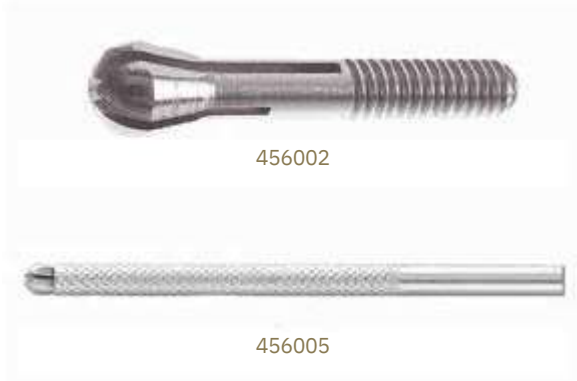

Catalog #	Description
456002	Replacement collet
456005	#3GS, 2-31/32" (7.5 cm)
456006	#3K, 4-1/8" (10.5 cm)
456007	#3KL, 6" (15 cm)

Specialty

WEBSTER SKIN GRAFT KNIFE HANDLE



Use with blade no. 450205, 7-1/4" (18.5 cm).

Catalog #	Description
050230	Handle only

GOULIAN SKIN GRAFT KNIFE SET



Includes: 1 Webster knife handle (050230), 5 Wecprep blades (450205), 3 depth gauges and guards (050203, 050204, 050205).

Catalog #	Description
050200	Complete

CVT FORCEPS AND CLAMPS

CVT FORCEPS AND CLAMPS

Tissue Forceps

DEBAKEY® THORACIC TISSUE FORCEPS



The row of 1 by 2 DeBakey®-type Serrations on the tips are designed to be large and strong enough to handle relatively large masses of tissue. Because of the groove construction and light spring tension, they may be used to hold and handle suture material as well. These forceps are of heavier design than the DeBakey® Vascular Tissue Forceps (351800 through 351814). The distal portion is tapered to a 3 mm DeBakey®-type Tip.

Catalog #	Description
342980	Straight, 3 mm tip, 6-1/8" (15.5 cm)
342981	Straight, 3 mm tip, 7-3/4" (19.5 cm)
342982	Straight, 3 mm tip, 9-1/2" (24 cm)
342984	Straight, 3 mm tip, 12" (30.5 cm)
342986	Angled, 3 mm tip, 12" (30.5 cm)

DEBAKEY® VASCULAR TISSUE FORCEPS

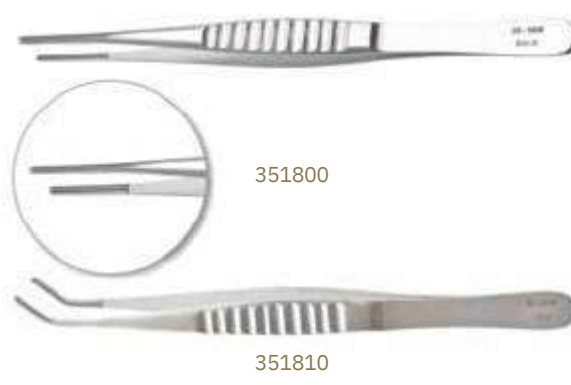

Standard. The distal 2 cm of these forceps is a narrow DeBakey®-type Tip with a width of 2 mm. The body of the instrument is constructed especially to prevent feathering, and all pins and projections have been omitted to help eliminate suture catchers. Jaws are very well fitted for handling tiny vessels as well as the smallest suture material.

Catalog #	Description
351800	Straight, 2 mm tip, 6" (15 cm)
351802	Straight, 2 mm tip, 7-3/4" (19.5 cm)
351804	Straight, 2 mm tip, 9-1/2" (24 cm)
351808	Straight, 2 mm tip, 12" (30.5 cm)
351810	Angled, 2 mm tip, 6" (15 cm)
351812	Angled, 2 mm tip, 7-3/4" (19.5 cm)
351814	Angled, 2 mm tip, 9-1/2" (24 cm)

CVT FORCEPS AND CLAMPS

Tissue Forceps

DEBAKEY® CARBIDE FORCEPS



DeBakey®-type Jaws at distal tip. Tungsten carbide insert behind the jaw for secure needle pulling actions.



351817

Catalog #	Description
351815	Regular forceps, 6" (15 cm), TC
351817	Regular forceps, 7-3/4" (19.5 cm), TC
351819	Regular forceps, 9-1/2" (24 cm), TC
351818	Delicate forceps, 7-3/4" (19.5 cm), TC
351824	Delicate forceps, 9-1/2" (24 cm), TC



351818

DEBAKEY® ULTRALIGHT FORCEPS



Approximately one-half the weight of standard DeBakey® Forceps, similar to that of titanium but at a much lower price. Ebonized stainless steel to reduce glare. Reduced tension minimizes fatigue and allows better control of delicate tissues.



351821

Catalog #	Description
351820	1.5 mm tip, 6" (15 cm)
351821	1.5 mm tip, 7-3/4" (19.5 cm)

CVT FORCEPS AND CLAMPS

Tissue Forceps

VASCULAR DEBAKEY® BAYONET TISSUE FORCEPS

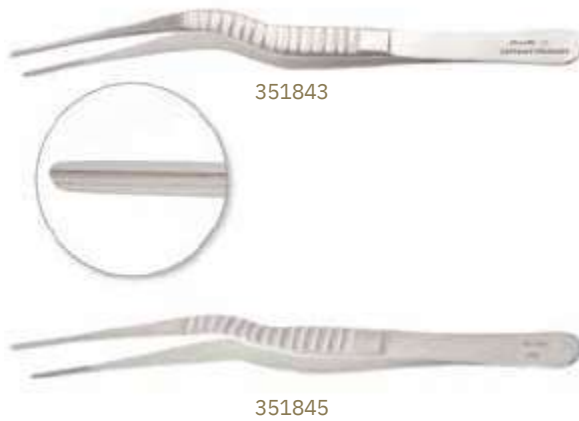

DeBakey®-type Jaws with a bayonet shape. Angled handles for difficult access and increased visibility.

Catalog #	Description
351843	Standard, 2.0 mm tip, 7-3/4" (19.5 cm)
351845	Fine, 1.3 mm tip, 7-3/4" (19.5 cm)

DEBAKEY® DIETRICH DELICATE VASCULAR TISSUE FORCEPS



Designed for micro-vascular and coronary artery surgery. The distal portion is tapered to a 1 mm extra-fine DeBakey®-type Tip.

Catalog #	Description
351801	Straight, 1 mm tip, delicate, 1 mm tip, 6" (15 cm)
351803	Straight, 1 mm tip, delicate, 1 mm tip, 7-3/4" (19.5 cm)
351806	Straight, 1 mm tip, delicate, 1 mm tip, 9-1/2" (24 cm)

DEBAKEY® DIETRICH DIAMA-GRIP TISSUE FORCEPS



Catalog #	Description
351803DG	Straight, 1.3 mm tip, 7-3/4" (20 cm)

CVT FORCEPS AND CLAMPS

Tissue Forceps

COOLEY JAW VASCULAR TISSUE FORCEPS



356000

Narrow double row of fine serrations on each jaw. For delicate handling of tiny vessels and fragile tissue.

Catalog #	Description
356000	6-1/4" (16 cm)
356002	8" (21 cm)
356003	9-1/2" (24 cm)

CORONARY ULTRA FINE TISSUE FORCEPS



351838

Catalog #	Description
351837	7" (18 cm)

GERALD DRESSING FORCEPS



351900

These are full-size dressing forceps with only the distal portion narrowed to provide light, delicate tips that maintain alignment.

Catalog #	Description
351900	Serrated, 7" (18 cm)
351902	Serrated, 9-3/4" (25 cm)

GERALD DRESSING FORCEPS



466225

Catalog #	Description
466225	Straight, serrated, 1.1 mm tip, 6-7/8" (17.5 cm), TC

CVT FORCEPS AND CLAMPS

Tissue Forceps

GERALD DEBAKEY® TISSUE FORCEPS



351901



351910

Delicate, tapered DeBakey®-type Jaws.

Catalog #	Description
351901	7" (18 cm)
351908	8" (20.5 cm)
351909	9-1/2" (24 cm)
351910	Angled, 6-7/8" (17.5 cm)

GERALD TISSUE FORCEPS



351905

These are full-size tissue forceps with only the distal portion narrowed to provide light, delicate tips that maintain alignment.

Catalog #	Description
351905	1 x 2 teeth, 7" (18 cm)
351907	1 x 2 teeth, 9-3/4" (25 cm)

CVT FORCEPS AND CLAMPS

Tissue Forceps

GERALD DIAMA-GRIP DRESSING FORCEPS



Catalog #	Description
351901DG	Straight, 1.1 mm tip, 7" (18 cm)

CARDIAC VALVE FORCEPS



Catalog #	Description
351748	9-1/2" (25 cm)

WHEELER TECHNIQUE® PLAQUE AND VESSEL FORCEPS



Very powerful grip at tips.

Catalog #	Description
351825	DeBakey®-type Jaw, 1.6 mm, 5-1/2" (14 cm)
351827	DeBakey®-type Jaw, 1.6 mm, 7-1/8" (18 cm)
351829	DeBakey®-type Jaw, 1.6 mm, 8-3/4" (22 cm)

NELSON TISSUE FORCEPS



Catalog #	Description
342950	6 x 7 sharp, fine teeth, 9" (23 cm)

CVT FORCEPS AND CLAMPS

Tissue Forceps

SINGLEY TISSUE FORCEPS



342933

Serrated ring end 8.5 mm wide. Medium-heavy construction.

Catalog #	Description
342933	9" (23 cm)

TUTTLE THORACIC TISSUE FORCEPS



342935

Light construction. Ring tips 6.8 mm wide.

Catalog #	Description
342935	9" (23 cm)

Micro Forceps

MICRO GRASPING FORCEPS



357681

8 mm round handle. 0.5 mm wide tips have fine cross-hatch serrations for secure yet delicate grip.

Catalog #	Description
357681	Straight, 7-7/8" (20 cm)

CVT FORCEPS AND CLAMPS

Micro Forceps

MICRO TYING FORCEPS

Round handle, 8 mm diameter.



Catalog #	Description
357658	Straight 0.5 mm wide tip with platform, 6" (15 cm)
357659	Curved 0.5 mm wide tip with platform, 6" (15 cm)
357660	Straight 0.5 mm wide tip with platform, 7-1/8" (18 cm)
357661	Curved 0.5 mm wide tip with platform, 7-1/8" (18 cm)



TEW TYING FORCEPS

Straight jaw with longitudinal serrations.



Catalog #	Description
394430	Straight, 0.6 mm tip, 7-1/8" (18 cm)
394431	Straight, 1 mm tip, 7-1/8" (18 cm)

CVT FORCEPS AND CLAMPS

Micro Forceps

MICRO RING TIP FORCEPS

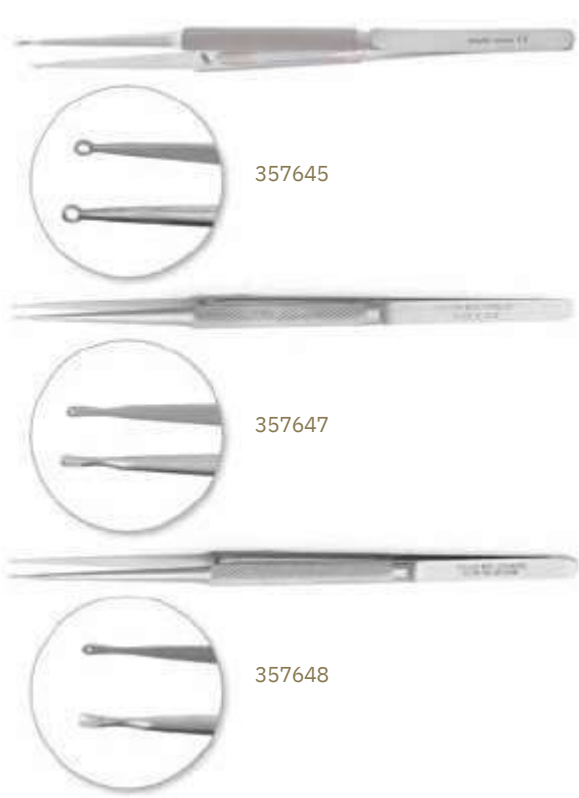

The 0.5 mm ring tip forceps are designed for the mammary/coronary arteries and other 1-3 mm sized vessels (e.g., tibial arteries in the lower leg). The 1.5 mm ring tip forceps are designed for larger vessels such as the saphenous vein, femoral arteries, etc. The ring tip forceps allows for a more secure grip on the tissue, yet it still has a very fine tip. The sizing 1.5 mm and 0.5 mm pertains to the size of the hole in the tip.

Catalog #	Description
357645	Saphenous/aorta, 1.5 mm ring tip forceps, 7" (18 cm)
357647	Mammary/coronary, 0.5 mm ring tip forceps, 7" (18 cm)
357648	Mammary/coronary, 0.5 mm ring tip forceps, 7-3/4" (20 cm)

MICRO DIAMA-GRIP RING FORCEPS



Diama-Grip jaws.

Catalog #	Description
357647DG	Small ring tip, 1 mm, 7" (18 cm)
357648DG	Small ring tip, 1.2 mm, 8" (21 cm)
357645DG	Large ring tip, 1.5 mm, 7" (18 cm)

CVT FORCEPS AND CLAMPS

Micro Forceps

DENIS MICRO RING FORCEPS



358007

Catalog #
358007

Description
Straight, smooth, 1 mm tip, Diama-Grip jaws,
8-1/4" (21 cm)

Ligature Carriers

DARLING TAPE PASSING CLAMP "AORTA GO AROUND"



353647

Specifically designed for passing ligature or tapes
around the intrarenal abdominal aorta. Slightly angled,
curved jaw with short segment of DeBakey®-type Teeth.

Catalog #
353647

Description
Curved, DeBakey® Jaw, 2" (5 cm) tip length, curved
shaft, 11-3/4" (29.5 cm)

DEBAKEY® MODIFIED SEMB LIGATURE CARRIER



353640

The distal 1.5 mm of the jaws are a DeBakey®-type
Design to securely hold a ligature or umbilical tape for
passage around the aorta. Jaws curve on 2.5 cm radius.

Catalog #
353640

Description
10-3/8" (26.5 cm)

CVT FORCEPS AND CLAMPS

Ligature Carriers

FAVALORO-SEMB LIGATURE CARRIERS



353645

Jaws are constructed so that only the distal DeBakey®-type surfaces approximate. The smooth portion of the jaws remains open to prevent inadvertent clamping of the aortic wall.

Catalog #	Description
353645	Half curved, 11-1/4" (28.5 cm)
353646	Full curved, 10-7/8" (27.5 cm)

SEMB DISSECTING FORCEPS



342710

For dissecting and breaking adhesions.

Catalog #	Description
342710	Slight curve, 10-1/4" (26 cm)

SEMB LIGATURE FORCEPS



342711

Acute curve. Tips perforated for use as a ligature carrier.

Catalog #	Description
342711	9-3/4" (25 cm)

CVT FORCEPS AND CLAMPS

Bronchus and Lung Clamps

BABCOCK TISSUE FORCEPS



342726

Catalog #	Description
183010	6-1/4" (16 cm)
183020	7-7/8" (20 cm) Serrated, 3/8" (9.5 mm) jaw,
342725	9-1/2" (24 cm) Serrated, 1/2" (12.5 mm) jaw,
342726	9-1/2" (24 cm)

BRONCHUS CLAMP



342804

25 degree angled DeBakey®-type Jaws are 5.5 cm long beyond angle.

Catalog #	Description
342804	9" (23 cm)

COLLIN LUNG TISSUE FORCEPS



342660

Light, screw lock box design. Teeth across entire distal edge.

Catalog #	Description
342660	5/8" (16 mm) jaw, 8" (20.5 cm)
342662	1-1/8" (28.5 mm) jaw, 8" (20.5 cm)
342664	1-1/8" (28.5 mm) jaw, 9" (23 cm)

CVT FORCEPS AND CLAMPS

Bronchus and Lung Clamps

DEBAKEY® LUNG GRASPING FORCEPS

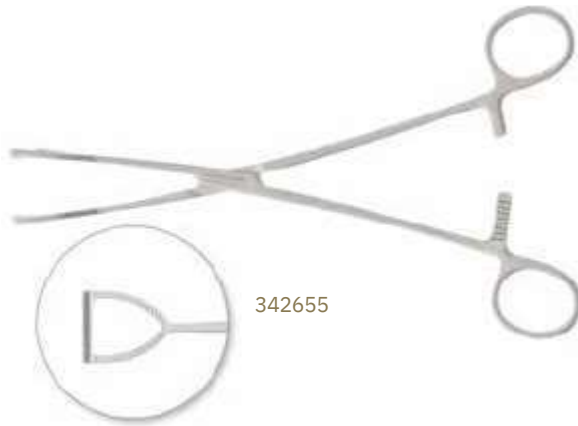

DeBakey®-type Distal Sections on specially shaped fenestrated jaws provide a soft but secure hold with minimum tissue damage. Distal edge of jaws is 2.5 cm wide.

Catalog #	Description
342655	9" (23 cm)

DUVAL LUNG TISSUE FORCEPS

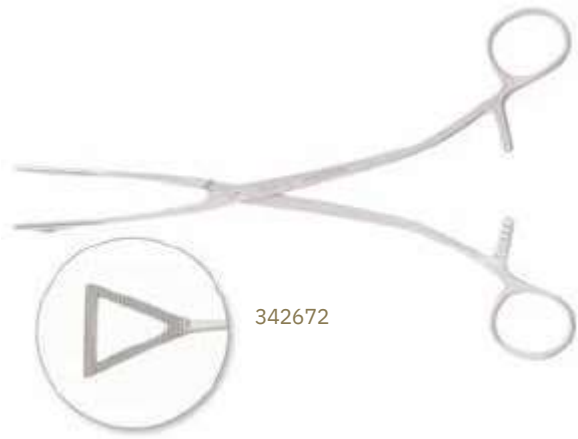

Light, screw lock box design. DeBakey®-type, serrated Jaws. Jaw width 1" (2.5 cm).

Catalog #	Description
342670	8" (21 cm)
342672	9" (23 cm)

CVT FORCEPS AND CLAMPS

Bronchus and Lung Clamps

LEES BRONCHUS CLAMPS



Also serves as a general purpose vascular clamp.
DeBakey®-type Jaw is 4 cm long beyond angle.

Catalog #	Description
342800	Right angle, 8-1/8" (20.5 cm)
342802	Angled, 10" (25.5 cm)

LOVELACE LUNG TISSUE FORCEPS



Catalog #	Description
342675	Angled to side, 1" (2.5 cm) DeBakey®-type Jaw, 7-1/2" (19 cm)

REVUELTA-GARCIA ALLIS CURVED CLAMPS



Half curved, DeBakey® Jaw.

Catalog #	Description
351743	10-1/8" (25.5 cm)
351744	10-7/8" (27.5 cm)

CVT FORCEPS AND CLAMPS

Bronchus and Lung Clamps

SAROT BRONCHUS CLAMPS



Teeth ensure a non-slipping hold on bronchus. Clamps are made in left and right models so that spiked blade will never be passed beneath the bronchus, thus avoiding trauma. Adult size 9-1/4" (23.4 cm) length to angle, 3.3 cm jaw length.

Catalog #	Description
342822	Right
342823	Left

WILLAUER-ALLIS TISSUE FORCEPS

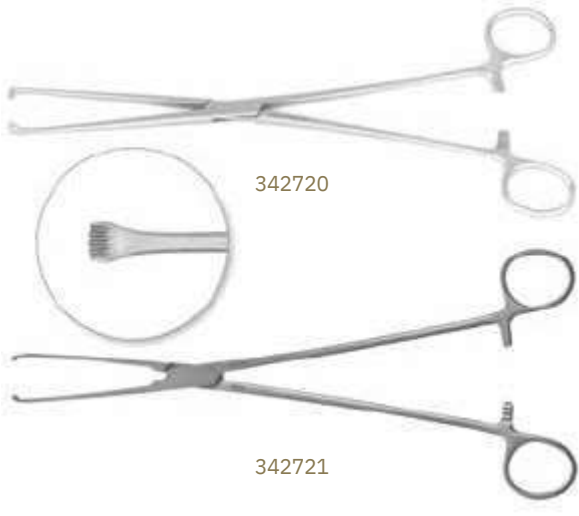

Extra long, springy, Allis-type forceps with 5 x 6 teeth. Dull, non-glare finish, stainless steel.

Catalog #	Description
342720	10" (25.5 cm)
342721	11-1/4" (28.5 cm)

CVT FORCEPS AND CLAMPS

Chest Drain Pulling Clamp

CHEST DRAIN PULLING CLAMP



Pointed Rochester-Pean-type hemostat with three spikes in the jaw for tunneling, grasping and pulling chest drains.

Catalog #	Description
343590	8-5/8" (22 cm)

SCISSORS

SCISSORS

Bandage Scissors and Shears

ESMARCH BANDAGE SCISSORS



142425

One large finger ring.

Catalog #	Description
142425	7-3/4" (19.5 cm)

ESMARCH PLASTER SHEARS



463885

Catalog #	Description
463885	7-7/8" (20 cm)

HERCULES PLASTER SCISSORS



GS31834

For lightweight plaster or aluminum casts.

Catalog #	Description
GS31834	Angled, one blade serrated, 7-1/2" (19 cm)

SCISSORS

Bandage Scissors and Shears

HI-LEVEL BANDAGE SCISSORS



GS31792

The delicate offset shanks provide better leverage. The fine knob slides easily under finger and toe bandages.

Catalog #	Description
GS31792	Shanks angled on side, one serrated blade, 5-1/2" (14 cm)

UTILITY SHEARS



GS31836

Effective for cloth or cotton wadding. One smooth and one serrated blade.

Catalog #	Description
GS31836	8-1/4" (21 cm)

KNOWLES BANDAGE SCISSORS



GS31804

For finger and toe bandages.

Catalog #	Description
GS31804	Straight, one serrated blade, 5-1/2" (14 cm)

SCISSORS

Bandage Scissors and Shears

LISTER BANDAGE SCISSORS



GS31680

Catalog #	Description
GS31680	4-1/2" (11.5 cm)

LISTER BANDAGE SCISSORS



142415

Pattern, satin finish.

Catalog #	Description
142415	5-3/4" (14.5 cm)
142420	7-1/4" (18.5 cm)
142422	8" (20.5 cm)

LISTER BANDAGE SCISSORS



463810

Weck® Pattern, bright finish.

Catalog #	Description
463810	5-3/4" (14.5 cm)
463830	7-1/4" (18.5 cm)

SCISSORS

Bandage Scissors and Shears

LISTER BANDAGE SCISSORS



One large finger ring.

Catalog #	Description
463840	8" (20.5 cm)

MOLESKIN SCISSORS



One blade serrated.

Catalog #	Description
GS69820	Straight, 7" (18 cm)
GS69824	Curved, 7-1/2" (19 cm)

SCISSORS

Bandage Scissors and Shears

MAKI™ SCISSORS



463820

Uniquely designed teeth to grip bottle caps, needles, tubing.

Catalog #	Description
463820	5-3/4" (14.5 cm)

UNIVERSAL SHEARS



142452

Stainless steel, comfortable polymer handles, serrated.

Catalog #	Description
142452	7-1/2" (19 cm)
GS11202	Red handles, 7-1/2" (19 cm)

SCISSORS

Stitch and Suture Removal Scissors

HILL STITCH SCISSORS



GS35084

Catalog #
GS35084Description
Curved, 4-3/8" (11 cm)

LITTAUER STANDARD SUTURE SCISSORS



142325

Catalog #
142325Description
5-1/2" (14 cm)

LITTAUER STITCH SCISSORS



GS35120

Catalog #
GS35120Description
Straight, 5-1/2" (14 cm)

SCISSORS

Stitch and Suture Removal Scissors

LITTLER STITCH SCISSORS



Catalog #
GS35078

Description
Curved, 4-5/8" (11.5 cm)

NORTHBENT STITCH SCISSORS



Catalog #
GS35104

Description
Curved on side, 5-1/8" (13 cm)

SCISSORS

Stitch and Suture Removal Scissors

SHORTBENT STITCH SCISSORS



Catalog #
GS35080

Description
Curved on side, delicate, 3-1/2" (9 cm)

SPENCER SCISSORS



Pattern, satin finish. Very delicate for fine sutures.

Catalog #
142312

Description
5" (12.5 cm)

SCISSORS

Stitch and Suture Removal Scissors

SPENCER STITCH SCISSORS



GS35092

Pattern, satin finish. Delicate, straight.

Catalog #	Description
GS35068	3-1/2" (9 cm)
GS35092	4-3/4" (12 cm)

SPENCER STITCH SCISSORS



520135

520140

Weck® Pattern, bright finish.

Catalog #	Description
520135	Slightly curved, 20 mm blades, 3-1/2" (9 cm)
520140	Straight, serrated, 30 mm blades, 5" (12.5 cm)

SCISSORS

Stitch and Suture Removal Scissors

SUTURE REMOVAL SCISSORS



Weck® Pattern, bright finish.

Catalog #	Description
056120	Curved, pointed, 22 mm blades, 4-3/4" (12 cm)

Wire Cutting Scissors

BANTAM WIRE CUTTING SCISSORS



Serrated 18 mm blades.

Catalog #	Description
520150	Straight, 4-3/8" (11 cm)
520152	Curved, 4" (10 cm)

SCISSORS

Wire Cutting Scissors

HEATH SUTURE AND WIRE CUTTING SCISSORS



520120

Catalog #	Description
520120	Curved sideways, serrated, 23 mm blades, 6" (15 cm)

ROGER WIRE CUTTING SCISSORS



520130

Weck® Pattern, bright finish.

Catalog #	Description
520130	One serrated blade, 15 mm blades angled sideways, 5" (12.5 cm)

WIRE SCISSORS



142518

Pattern, satin finish. Angular with notch for wire.

Catalog #	Description
142515	Stainless steel blades, one serrated, 5" (12.5 cm)
142518	TC blades, 5" (12.5 cm)

SCISSORS

Wire Cutting Scissors

WIRE CUTTING SCISSORS



Pattern, satin finish.

Catalog #	Description
GS35200	Angular carbide, one serrated blade, 4-3/4" (12 cm), TC

VERNON WIRE SCISSORS



Straight, serrated blades.

Catalog #	Description
790310	32 mm blades, 5-3/4" (14.5 cm)
790315	42 mm blades, 7-1/2" (19 cm)

Operating Scissors

DELICATE OPERATING SCISSORS



Sharp/Blunt.

Catalog #	Description
460180	Straight, 5" (12.5 cm)

SCISSORS

Operating Scissors

OPERATING SCISSORS, B/B



460170

Blunt/Blunt, stainless steel.

Catalog #	Description
460165	Straight, 5" (12.5 cm)
460219	Curved, 5-1/2" (14 cm)
460170	Straight, 5-3/4" (14.5 cm)
460179	Straight, 6" (15 cm)
460177	Straight, 7" (18 cm)

OPERATING SCISSORS, S/B



460220

Sharp/Blunt, stainless steel.

Catalog #	Description
460100	Straight, 4-3/4" (12 cm)
460105	Straight, 5" (12.5 cm)
460110	Straight, 5-1/2" (14 cm)
460220	Curved, 5-1/2" (14 cm)
460175	Straight, 6" (15 cm)
460115	Straight, 6-3/4" (17 cm)

OPERATING SCISSORS, S/S



460245

Sharp/Sharp, stainless steel.

Catalog #	Description
460245	Curved, 5-1/2" (14 cm)
460135	Straight, 5" (12.5 cm)
460140	Straight, 5-1/2" (14 cm)

SCISSORS

Operating Scissors OPERATING SCISSORS, TC



464502

5-1/2" (14 cm), TC.

Catalog #	Description
464500	Sharp/Blunt
464502	Sharp/Sharp

OPERATING SCISSORS



141146

141106

Pattern, satin finish.

Catalog #	Description
141146	Sharp/Blunt, straight, 5-1/2" (14 cm)
141106	Sharp/Sharp, straight, 5-3/4" (14.5 cm)

Mayo-Type Scissors

MAYO BEVELED BLADE SCISSORS



141317

Catalog #	Description
141310	Straight, 5-3/4" (14.5 cm)
141315	Curved, 5-3/4" (14.5 cm)
141312	Straight, 6-3/4" (17 cm)
141317	Curved, 6-3/4" (17 cm)

SCISSORS

Mayo-Type Scissors

MAYO ROUND SURFACE BLADE SCISSORS



Catalog #
141332

Description
Straight, 6-3/4" (17 cm)

141332

MAYO DISSECTING SCISSORS



460400

Weck® Pattern, bright finish.

Catalog #	Description
460410	Curved, 43 mm blades, 5-1/2" (14 cm)
460400	Straight, 43.5 mm blades, 5-5/8" (14.5 cm)
460420	Straight, 51.5 mm blades, 6-3/4" (17 cm)
460430	Curved, 49.5 mm blades, 6-3/4" (17 cm)
460620	Straight, 64 mm blades, 8-3/4" (22 cm)
460630	Curved, 64 mm blades, 8-3/4" (22 cm)

MAYO DISSECTING SCISSORS



460461

Weck® Pattern, bright finish, lightweight,
6-1/2" (16.5 cm).

Catalog #	Description
460460	Straight
460461	Curved

SCISSORS

Mayo-Type Scissors

MAYO DISSECTING SCISSORS, TC



Pattern, satin finish. Beveled blade.

Catalog #	Description
142220	Curved, 5-1/2" (14 cm), TC
142235	Curved, 9" (23 cm), TC
142237	Straight, 9" (23 cm), TC

MAYO DISSECTING SCISSORS, TC



Weck® Pattern, bright finish. Round blade.

Catalog #	Description
464605	Curved, 5-3/4" (14.5 cm), TC
464615	Curved, 6-1/2" (16.5 cm), TC
464600	Straight, 5-3/4" (14.5 cm), TC
464610	Straight, 6-1/2" (16.5 cm), TC

SCISSORS

Mayo-Type Scissors

MAYO NOBLE SCISSORS



6-1/2" (16.5 cm).

Catalog #	Description
460600	Straight
460601	Curved

460601

MAYO-HARRINGTON SCISSORS



11" (28 cm).

Catalog #	Description
462120	Straight
462121	Curved

462121

MAYO-STILLE SCISSORS



Catalog #	Description
GS34306	Straight, 5-1/2" (14 cm)
GS34308	Curved, 5-1/2" (14 cm)
GS34310	Straight, 6-3/4" (17 cm)
GS34312	Curved, 6-3/4" (17 cm)

GS34312

SCISSORS

Mayo-Type Scissors

CHURCH SCISSORS



352250

Lightly constructed, long scissors with a beveled surface. Mayo style blades. Blunt, dissecting tips.

Catalog #	Description
352250	Curved, 6-3/4" (17 cm)
352240	Straight, 7" (18 cm)

COOLEY-MAYO CURVED SCISSORS



352090

Catalog #	Description
352090	7-1/2" (19 cm)

DOYEN ABDOMINAL SCISSORS



GS34336

Pattern, satin finish.

Catalog #	Description
GS34334	Straight, 7" (18 cm)
GS34336	Curved, 7" (18 cm)

SCISSORS

Mayo-Type Scissors

DOYEN SCISSORS



141395

Pattern, satin finish.

Catalog #	Description
141395	Straight, 7-1/4" (18.5 cm)

DOYEN FERGUSON SCISSORS



460720

Catalog #	Description
460720	Angled on flat, 59 mm blades, 7-1/8" (18 cm)

SIMS SCISSORS



GS67174

8" (20.5 cm).

Catalog #	Description
GS67164	Straight, Sharp/Sharp blades
GS67166	Straight, Sharp/Blunt blades
GS67168	Straight, Blunt/Blunt blades
GS67170	Curved, Sharp/Sharp blades
GS67172	Curved, Sharp/Blunt blades
GS67174	Curved, Blunt/Blunt blades

SCISSORS

Mayo-Type Scissors

SISTRUNK FINE SCISSORS



Delicate, 5-1/2" (14 cm).

Catalog #	Description
GS34348	Straight
GS34354	Curved

SISTRUNK HEAVY SCISSORS



Catalog #	Description
GS34356	Straight, 5-1/2" (14 cm)

JORGENSON SCISSORS



Heavy, rigid body with acutely curved blades that taper to a rounded narrow tip.

Catalog #	Description
342273	8-3/4" (22 cm)

SCISSORS

Mayo-Type Scissors

THOREK SCISSORS



Medium weight construction, round surface, acutely curved blades.

Catalog #	Description
342270	7-1/4" (18.5 cm)
342272	10" (25.5 cm)

MARTIN CARTILAGE SCISSORS



Catalog #	Description
790320	Curved, serrated blades, 8" (20.5 cm)

DEAN SCISSORS

Catalog #	Description
GS34642	Angled, serrated, 7" (18 cm)

GORNEY RHYTIDECTOMY SCISSORS



Catalog #	Description
442560	Straight, serrated, 6-3/4" (17 cm)

SCISSORS

Metzenbaum-Type Scissors

BABY METZENBAUM SCISSORS



Weck® Pattern, bright finish.

Catalog #	Description
056310	Curved, 5-3/4" (14.5 cm)

LAHEY (BABY METZ) SCISSORS



Pattern, satin finish.

Catalog #	Description
141450	Straight, 5-3/4" (14.5 cm)
141452	Curved, 5-3/4" (14.5 cm)

METZENBAUM SCISSORS, DELICATE



Pattern, satin finish. Delicate curved.

Catalog #	Description
141448	5-1/2" (14 cm)
352235	7" (18 cm)
352237	8" (20.5 cm)

SCISSORS

Metzenbaum-Type Scissors

METZENBAUM SCISSORS, DELICATE

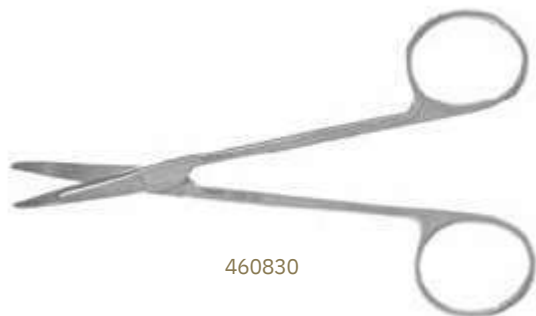

460830

Catalog #
460830

Description
Curved, 29 mm delicate blades with cut-out,
5" (12.5 cm)

METZENBAUM SCISSORS



141467

Pattern, satin finish.

Catalog #	Description
141460	Straight, 7" (18 cm)
141462	Curved, 7" (18 cm)
141467	Curved, 8-1/4" (21 cm)
141469	Curved, 9" (23 cm)

SCISSORS

Metzenbaum-Type Scissors

METZENBAUM SCISSORS

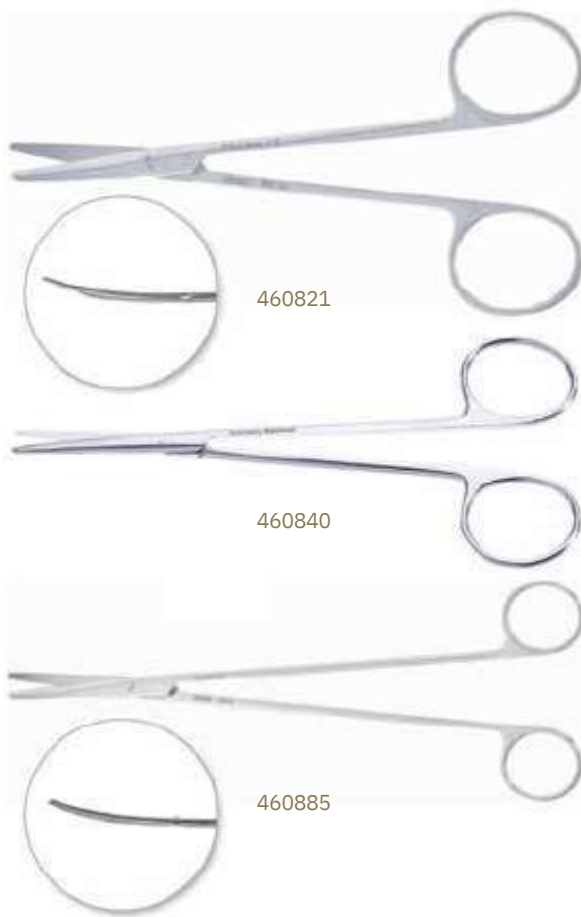

Weck® Pattern, bright finish.

Catalog #	Description
460820	Straight, 5" (12.5 cm)
460821	Curved, 5" (12.5 cm)
460840	Straight, 5-3/8" (13.5 cm)
460841	Curved, 5-3/8" (13.5 cm)
460880	Straight, 5-3/8" (13.5 cm)
460881	Curved, 5-3/8" (13.5 cm)
460870	Straight, 7" (18 cm)
460871	Curved, 7" (18 cm)
460884	Straight, 9" (23 cm)
460885	Curved, 9" (23 cm)
462105	Straight, 10-3/8" (26.5 cm)
462110	Curved, 10-1/4" (26 cm)
460889	Curved, 11" (28 cm)

SCISSORS

Metzenbaum-Type Scissors

METZENBAUM SCISSORS



Pattern, satin finish, 6" and 8".

Catalog #	Description
GS34458	Straight, 6" (15 cm)
GS34462	Curved, 6" (15 cm)
GS34472	Straight, 8" (20.5 cm)
GS34474	Curved, 8" (20.5 cm)

METZENBAUM SCISSORS, TC



Sharp/Sharp.

Catalog #	Description
464707	Curved, 5-3/4" (14.5 cm), TC
464712	Straight, 7" (18 cm), TC
464718	Curved, 7" (18 cm), TC
464722	Straight, 9" (23 cm), TC
464727	Curved, 9" (23 cm), TC

SCISSORS

Metzenbaum-Type Scissors

METZENBAUM SCISSORS, TC



Weck® Pattern, bright finish.

Catalog #	Description
464700	Straight, 5-3/4" (14.5 cm), TC
464705	Curved, 5-3/4" (14.5 cm), TC
464710	Straight, 7" (18 cm), TC
464715	Curved, 7" (18 cm), TC
464720	Straight, 9" (23 cm), TC
464725	Curved, 9" (23 cm), TC

METZENBAUM SCISSORS, DELICATE, TC



Delicate. Blunt/Blunt.

Catalog #	Description
464701	Straight, 5-3/4" (14.5 cm), TC
464706	Curved, 5-3/4" (14.5 cm), TC
464711	Straight, 7" (18 cm), TC
464716	Curved, 7" (18 cm), TC
464721	Straight, 9" (23 cm), TC
464726	Curved, 9" (23 cm), TC

SCISSORS

Metzenbaum-Type Scissors

DEBAKEY® SCISSORS



Sturdy Metzenbaum-type scissors. Black rings for quick identification.

Catalog #	Description
342160	Curved, 5-3/4" (14.5 cm), TC
342162	Curved, 7" (18 cm), TC
342166	Curved, 9-1/8" (23 cm), TC
342167	Curved, 10-1/4" (26 cm), TC
342168	Curved, 11-1/4" (28.5 cm), TC
342169	Curved, 12" (30.5 cm), TC

DEBAKEY®-METZENBAUM DISSECTING SCISSORS



Curved blades. These scissors are proportionately matched in weight.

Catalog #	Description
342200	Curved, 5-7/8" (15 cm)
342201	Curved, 7" (18 cm)
342202	Curved, 8-1/8" (20.5 cm)
342203	Curved, 9-1/8" (23 cm)
342204	Curved, 10-1/4" (26 cm)
342206	12-1/4" (31 cm)

DEMARTEL ACUTELY ANGLED SCISSORS



Lightweight construction.

Catalog #	Description
352210	Angled on flat 50 degrees, short, 16 mm blades, sharp tips, 7" (18 cm)

SCISSORS

Metzenbaum-Type Scissors

DEMARTEL SCISSORS

Very slim, light construction.



Catalog #	Description
352120	Straight, sharp blades, 6-3/4" (17 cm)
352106	Angled on flat, blunt blades, 6-3/4" (17 cm)
352109	Curved, blunt blades, 6-3/4" (17 cm)
352129	Curved, sharp blades, 6-3/4" (17 cm)
352100	Straight, blunt blades, 7" (18 cm)
352103	Angled on flat, blunt tips, 7" (18 cm)
352123	Angled on flat, sharp blades, 7" (18 cm)
352126	Angled to side, sharp blades, 6-7/8" (17.5 cm)

FERGUSON LONG DISSECTING SCISSORS

With Metzenbaum-type, curved blades.



Catalog #	Description
342275	10-1/4" (26 cm)

SCISSORS

Metzenbaum-Type Scissors

NELSON LOBECTOMY SCISSORS



Pattern, satin finish, medium weight with rounded Metzenbaum-type curved blades.

Catalog #	Description
342242	10-1/4" (26 cm)
342243	11-1/4" (28.5 cm)
342245	14-1/4" (36 cm)

NELSON SCISSORS



Weck® Pattern, bright finish.

Catalog #	Description
462148	Straight, 8" (20.5 cm)
462149	Curved, 8" (20.5 cm)
462150	Straight, 9" (23 cm)
462151	Curved, 9" (23 cm)

NELSON SCISSORS, TC



Catalog #	Description
464800	Curved, 11-1/8" (28.5 cm), TC
464801	Curved, 11-1/4" (28.5 cm), TC

SCISSORS

Metzenbaum-Type Scissors

JAMISON-METZENBAUM TENOTOMY SCISSORS



The standard Metzenbaum-style curved blades have specially narrowed tenotomy-type distal tips.

Catalog #	Description
342220	6" (15 cm)
342221	7" (18 cm)
342222	8" (20.5 cm)
342223	9" (23 cm)

POTTS TENOTOMY SCISSORS



Catalog #	Description
640280	Curved, 6" (15 cm)

SCISSORS

Metzenbaum-Type Scissors

LINCOLN-METZENBAUM SCISSORS



460883

Rounded, narrow dissecting tips.

Catalog #	Description
460883	Curved, 5-3/8" (13.5 cm)
460873	Curved, 7" (18 cm)

LINCOLN SCISSORS



462201

Small, rounded dissecting blades.

Catalog #	Description
461310	Straight, 6-1/2" (16.5 cm)
461311	Curved, 6-1/2" (16.5 cm)
462201	Curved, 11" (28 cm)

STRULLY PROBED TIP SCISSORS



462530

Catalog #	Description
462530	Curved, 8" (20.5 cm)

SCISSORS

Delicate and Iris-Type Scissors

DIGITATE®-HEIFETZ SCISSORS



Catalog #	Description
066102	Curved, 5-3/4" (14.5 cm)
066100	Straight, 5-3/4" (14.5 cm)
066104	Straight, 4-3/4" (12 cm)



066102

MCCLURE IRIS SCISSORS



Catalog #	Description
144295	Angled, 4-3/4" (12 cm)



144295

SCISSORS

Delicate and Iris-Type Scissors

IRIS SCISSORS WITH BARRAQUER HANDLE



Catalog #
055502

Description
Curved, 18 mm blades, 5-3/4" (14.5 cm)

BLEPHAROPLASTY SCISSORS

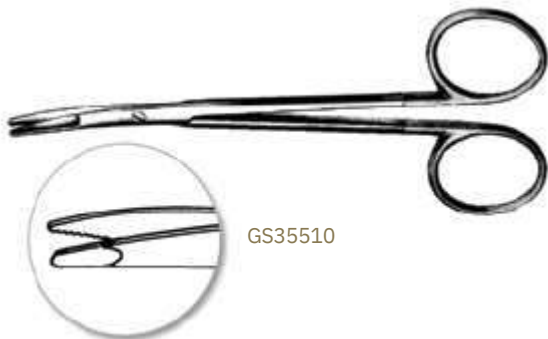

Catalog #
GS35510

Description
Curved flat tips, one serrated and one carbide blade,
4-1/2" (11.5 cm), TC

SCISSORS

Delicate and Iris-Type Scissors

GRADLE SCISSORS



Slightly curved, Sharp/Sharp.

Catalog #	Description
GS53316	3-3/4" (9.5 cm)
GS53318	4" (10 cm)

IRIS MINIATURE SCISSORS



Catalog #	Description
055100	Straight, 15 mm blades, 3-1/2" (9 cm)

SCISSORS

Delicate and Iris-Type Scissors

IRIS RIBBON SCISSORS



GS53267

Slightly curved, Sharp/Sharp.

Catalog #	Description
GS53265	3-3/4" (9.5 cm)
GS53267	4" (10 cm)

IRIS SCISSORS



144300

Pattern, satin finish.

Catalog #	Description
144300	Straight, 4-1/2" (11.5 cm), stainless steel
144310	Curved, 4-1/2" (11.5 cm), stainless steel
144315	Straight, 4-1/2" (11.5 cm), TC
144317	Curved, 4-1/2" (11.5 cm), TC

IRIS SCISSORS



462600

Weck® Pattern, bright finish.

Catalog #	Description
462600	Curved, 25 mm blades, 4-1/2" (11.5 cm)
462605	Straight, 25 mm blades, 4-1/2" (11.5 cm)
462640	Straight, 30 mm blades, 5" (12.5 cm)
462641	Curved, 28 mm blades, 5" (12.5 cm)

SCISSORS

Delicate and Iris-Type Scissors

IRIS SCISSORS, TC



Weck® Pattern, bright finish.

Catalog #	Description
462632	Straight, 4-1/2" (11.5 cm), TC
462633	Curved, 4-1/2" (11.5 cm), TC

JOSEPH SCISSORS



Catalog #	Description
442510	Straight, 5-3/4" (14.5 cm)
442512	Curved, 5-3/4" (14.5 cm)

KAYE SCISSORS



Catalog #	Description
464220	Curved, 32 mm serrated blades, 4-1/2" (11.5 cm), TC

SCISSORS

Delicate and Iris-Type Scissors

KELLY FISTULA SCISSORS



GS34607

Smooth, Sharp/Sharp.

Catalog #	Description
GS34602	Straight, 6-1/4" (16 cm)
GS34607	Curved, 6-1/4" (16 cm)
GS34612	Angled, 6-1/4" (16 cm)

DUFFIELD SCISSORS



461431

Sharp/Sharp.

Catalog #	Description
461430	Straight, 28 mm blades, 6-1/2" (16.5 cm)
461431	Curved, 28 mm blades, 6-1/2" (16.5 cm)

KNAPP IRIS SCISSORS



144340

One sharp and one blunt point, 4-1/2" (11.5 cm).

Catalog #	Description
144338	Straight
144340	Curved

SCISSORS

Delicate and Iris-Type Scissors

LA GRANGE SCISSORS



Catalog #	Description
GS34621	Curved, 4-1/2" (11.5 cm)

PAR SCISSORS



Catalog #	Description
464810	Curved, 4-1/2" (11.5 cm), TC

SCISSORS

Delicate and Iris-Type Scissors

PLASTIC SCISSORS



Catalog #	Description
442502	Curved, 4-3/4" (12 cm)

PLASTIC SCISSORS



Pointed, sharp, 34 mm blades, 4-3/4" (12 cm).

Catalog #	Description
056200	Straight
056201	Curved

SCISSORS

Delicate and Iris-Type Scissors

RAGNELL SCISSORS, DELICATE



442576

Catalog #	Description
442576	Half-curved, 4-3/4" (12 cm)

RAGNELL SCISSORS



GS34560

Curved, flat blunt tips.

Catalog #	Description
GS34560	5" (12.5 cm)
GS34562	7" (18 cm)

SHEA VEIN GRAFT SCISSORS



442525

Catalog #	Description
442525	Flat tips, 4-3/4" (12 cm)

SCISSORS

Delicate and Iris-Type Scissors

STEVENS TENOTOMY



GS53174

Pattern, satin finish, Sharp/Sharp points.

Catalog #	Description
GS53174	Straight, 4-3/8" (11 cm)
GS53176	Curved, 4-3/8" (11 cm)

STEVENS TENOTOMY



144352

Pattern, satin finish, slender style.

Catalog #	Description
144350	Straight, 4-1/2" (11.5 cm)
144352	Slightly curved blades, 4-1/2" (11.5 cm)

STEVENS TENOTOMY, DELICATE



442515

Pattern, satin finish.

Catalog #	Description
442515	Curved, 5" (12.5 cm)

SCISSORS

Delicate and Iris-Type Scissors

STEVENS TENOTOMY



462681

Weck® Pattern, bright finish.

Catalog #	Description
462680	Straight, 4-1/2" (11.5 cm)
462681	Curved, 4-1/2" (11.5 cm)
056110	Curved, 5-1/8" (13 cm)

STRABISMUS SCISSORS



144321

Pattern, satin finish. Rounded blades and tips.

Catalog #	Description
144319	Straight, 4-1/2" (11.5 cm), TC
144321	Curved, 4-1/2" (11.5 cm), TC
144330	Straight, round shank, 4-3/4" (12 cm), stainless steel
144332	Curved, round shank, 4-3/4" (12 cm), stainless steel

STRABISMUS SCISSORS



462691

Weck® Pattern, bright finish. Rounded 30 mm dissecting blades.

Catalog #	Description
462690	Straight, 4-1/2" (11.5 cm)
462691	Curved, 4-1/2" (11.5 cm)

SCISSORS

Delicate and Iris-Type Scissors

WUTZLER SCISSORS

28 mm dissecting blades.

Catalog #	Description
462540	Straight, Blunt/Blunt blades, 5" (12.5 cm)
462541	Curved, Blunt/Blunt blades, 5" (12.5 cm)
462550	Straight, Sharp/Sharp blades, 4-3/4" (12 cm)



GOLDMAN-FOX SCISSORS

Catalog #	Description
GS34648	Curved, serrated, 5" (12.5 cm)



SCISSORS

Super-Cut and Ultimate-Cut Scissors

Our Super-Cut Scissors and Ultimate-Cut Scissors are manufactured with the finest surgical stainless steel, the latest heat treating methods and master craftsmanship.

Both style scissors are designed with one razor-sharp blade edge. The Super-Cut scissors' opposite blade has a standard smooth edge, while the Ultimate-Cut scissors' opposite blade incorporates a micro-serrated edge.

SUPER-CUT LISTER BANDAGE SCISSORS



GS35210

Catalog #	Description
GS35210	5-3/4" (14.5 cm)
GS35212	7-1/4" (18.5 cm)

SUPER-CUT HI-LEVEL BANDAGE SCISSORS



GS35202

The delicate offset shanks and the sharp Super-Cut edge provide better leverage. The fine knob slides easily under finger bandages.

Catalog #	Description
GS35202	Straight, angled on side, 5-1/2" (14 cm)

SUPER-CUT LISTER BANDAGE SCISSORS WITH LARGE FINGER RING



GS35214

Razor-sharp scissors ideal for cutting heavy material including: moleskin, drapes and stockinette. Not recommended for fiberglass or plaster splints. Oversized finger ring helps relieve pressure on the third metacarpal.

Catalog #	Description
GS35214	Straight, 8" (20.5 cm)

SCISSORS

Super-Cut and Ultimate-Cut Scissors

SUPER-CUT OPERATING SCISSORS



Sharp/Blunt.

Catalog #	Description
GS35220	Straight, 5-1/2" (14 cm)
GS35250	Curved, 5-3/4" (14.5 cm)

GS35250

SUPER-CUT MAYO SCISSORS



Beveled blades, blunt points.

Catalog #	Description
GS35280	Straight, 5-3/4" (14.5 cm)
GS35286	Curved, 5-3/4" (14.5 cm)
GS35292	Straight, 6-3/4" (17 cm)
GS35298	Curved, 6-3/4" (17 cm)
GS35316	Straight, 9-1/4" (23.5 cm)
GS35322	Curved, 9" (23 cm)
GS35340	Curved, 11" (28 cm)

GS35298

ULTIMATE-CUT COOLEY SCISSORS



Catalog #	Description
463950	Curved, with one serrated blade, 7-3/4" (19.5 cm)

463950

SCISSORS

Super-Cut and Ultimate-Cut Scissors

SUPER-CUT (BABY) METZENBAUM SCISSORS



GS35364

Blunt points.

Catalog #	Description
GS35364	Straight, 4-1/2" (11.5 cm)
GS35370	Curved, 4-1/2" (11.5 cm)

SUPER-CUT METZENBAUM SCISSORS



GS35382

Blunt points.

Catalog #	Description
GS35380	Straight, 6" (15 cm)
GS35382	Curved, 5-5/8" (14.5 cm)
GS35392	Straight, 7" (18 cm)
GS35394	Curved, 7" (18 cm)
GS35396	Curved, delicate, 7" (18 cm)
GS35406	Curved, 8" (20.5 cm)
GS35418	Curved, 9" (23 cm)
GS35430	Curved, 11-1/4" (28.5 cm)

SUPER-CUT JAMISON SCISSORS



GS35496

Catalog #	Description
GS35496	Curved blunt points, very delicate, 6-1/4" (16 cm)

SCISSORS

Super-Cut and Ultimate-Cut Scissors

SUPER-CUT STEVENS SCISSORS



Blunt points. Delicate short narrow tips for dissecting fine tissue.

Catalog #	Description
GS35484	Straight, 4-1/2" (11.5 cm)
GS35490	Curved, 4-1/2" (11.5 cm)
GS35494	Curved, 5-1/4" (13.5 cm)

SUPER-CUT IRIS SCISSORS



Sharp points.

Catalog #	Description
GS35450	Straight, 3-1/2" (9 cm)
GS35452	Curved, 3-1/2" (9 cm)
GS35454	Straight, 4-1/2" (11.5 cm)
GS35460	Curved, 4-1/2" (11.5 cm)

SCISSORS

Super-Cut and Ultimate-Cut Scissors

ULTIMATE-CUT MAYO SCISSORS



463903

Catalog #	Description
463900	Straight, 6-3/4" (17 cm)
463901	Curved, 6-3/4" (17 cm)
463903	Curved, 9-1/8" (23 cm)

Your paragraph text

ULTIMATE-CUT METZENBAUM SCISSORS



463912

Catalog #	Description
463910	Straight, 5-3/4" (14.5 cm)
463911	Curved, 5-3/4" (14.5 cm)
463912	Straight, 6-7/8" (17.5 cm)
463913	Curved, 7" (18 cm)
463915	Curved, 9" (23 cm)

ULTIMATE-CUT POTTS SCISSORS



463941

Catalog #	Description
463941	Angled 45 degrees, with one serrated blade, 7-1/4" (18.5 cm)

SCISSORS

Super-Cut and Ultimate-Cut Scissors

ULTIMATE-CUT STEVENS TENOTOMY SCISSORS



463920

Catalog #
463920
463921

Description
Straight, 4-1/2" (11.5 cm)
Curved, 4-1/2" (11.5 cm)

IRIS SCISSORS



463932

Sharp/Sharp.

Catalog #
463930
463932

Description
Straight with one serrated blade, 4-1/2" (11.5 cm)
Curved with one serrated blade, 4-1/2" (11.5 cm)

BULLDOG

BULLDOG® AND MICRO VESSEL CLAMPS

Bulldog® Clamps

DEBAKEY® CROSS ACTION BULLDOG® CLAMPS



353050



353052



353054



353062

These DeBakey®-type Jaw Clamps are used for temporary occlusion of major peripheral arteries. They are made in several sizes to facilitate their application under varying circumstances. They present a relatively smooth surface with particular attention to the elimination of suture-catching projections.

Catalog#	Description
353050	Straight, 3/4" (2 cm) tip length, 3-1/8" (8 cm)
353052	Straight, 1-1/8" (3 cm) tip length, 3-1/2" (9 cm)
353054	Straight, 2" (5 cm) tip length, 4-1/4" (11 cm)
353056	Straight, 2-5/8" (6.8 cm) tip length, 4-7/8" (12.5 cm)
353060	Curved, 5/8" (1.5 cm) tip length, 2-7/8" (7.5 cm)
353062	Curved, 1" (2.5 cm) tip length, 3-1/4" (8 cm)
353064	Curved, 1-5/8" (4 cm) tip length, 3-7/8" (10 cm)
353066	Curved, 2-1/8" (5.5 cm) tip length, 4-1/4" (11 cm)

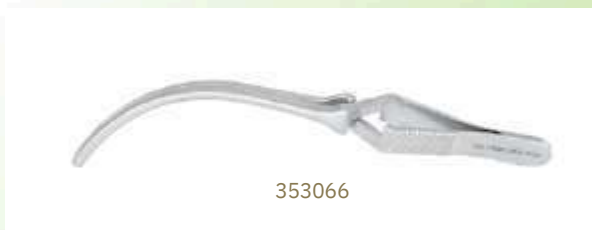

353066

BULLDOG® AND MICRO VESSEL CLAMPS

Bulldog®Clamps

DIETRICH BULLDOG® CLAMPS

Low tension clamps for coronary arteries.



353150

Catalog #	Description
353150	Straight, 3/8" (9.5 mm) jaw
353151	Straight, 1/2" (12 mm) jaw
353152	Straight, 3/4" (20 mm) jaw
353153	Angled, 5/16" (8 mm) jaw
353154	Angled, 1/2" (12 mm) jaw
353155	Angled, 3/4" (20 mm) jaw



353151



353154



353152



353153



353155

EFFLER-GROVES SPECIAL LIGHTWEIGHT BULLDOG® CLAMP

Delicate model for clamping the mammary artery.



355819

Catalog #	Description
355819	2-3/4" (7 cm)

BULLDOG® AND MICRO VESSEL CLAMPS

Bulldog® Clamps

GLOVER STYLE BULLDOG® CLAMPS



353100



353102



353105



353112



With DeBakey®-type Jaws. These clamps are designed to permit regulation of the tension by means of an adjusting screw. The largest sizes are made specifically for temporary occlusion of large arteries such as the carotid, subclavian and iliac.

Catalog #	Description
353100	Straight, 3/4" (2 cm) jaw, 2-1/4" (5.5 cm)
353102	Straight, 1-1/4" (3.5 cm) jaw, 2-3/4" (7 cm)
353105	Straight, 1-5/8" (4 cm) jaw, 3-1/2" (9 cm)
353110	Curved, 5/8" (1.5 cm) jaw, 2" (5 cm)
353112	Curved, 1" (2.5 cm) jaw, 2-1/2" (6 cm)
353115	Curved, 1-3/8" (3.5 cm) jaw, 3-1/8" (8 cm)
353120	Angled, 1-1/4" (3.5 cm) jaw, 1-7/8" (5 cm)



353120

BULLDOG® AND MICRO VESSEL CLAMPS

Bulldog®Clamps

HESS ANGULAR MOSQUITO TIP SERREFINE



The pointed, serrated tips greatly facilitate cannulation of very small blood vessels where exposure is limited. The weak spring avoids crushing the vasculature.

Catalog #	Description
353025	2-1/8" (5.5cm)

JACOBSON BULLDOG® CLAMPS



Catalog #	Description
353131	Straight, 1-7/8" (5 cm)
353132	Curved, 1-5/8" (4.5 cm)

BULLDOG® AND MICRO VESSEL CLAMPS

Bulldog®Clamps

JOHNS HOPKINS (BLALOCK) BULLDOG® CLAMPS



353001



353002



353003

Catalog #
 353001
 353002
 353003
 353011
 353012
 353014
 353016

Description
 Straight, 1-1/2" (4 cm)
 Straight, 1-7/8" (5 cm)
 Straight, 2-1/4" (5.5 cm)
 Curved, 1-1/2" (4 cm)
 Curved, 1-7/8" (5 cm)
 Curved, 2-1/2" (6.5 cm)
 Curved, 3" (7.5 cm)



353012



353014

SANTULLI ANGULAR MODEL BULLDOG® CLAMP



353070

Catalog #
 353070

Description
 Angled, DeBakey® Jaw length 1-5/8" (4 cm)

BULLDOG® AND MICRO VESSEL CLAMPS

Bulldog®Clamps

SENNING FEATHERWEIGHT BULLDOG® CLAMPS



353135

Very lightweight at 2 grams. Available in four tensions. Tension may be readjusted if necessary. Parallel jaws consist of double, opposing, finely serrated rows. 1-3/4" (4.5 cm).

Catalog #	Description
353135	No. 1, Strong
353136	No. 2, Medium Strong
353137	No. 3, Medium Light
353138	No. 4, Light



353136



353137



353138

BULLDOG® AND MICRO VESSEL CLAMPS

Bulldog®Clamps

WOOD BULLDOG® CLAMPS



353123



353125



353124



353126

Strong closing pressure.

Catalog #	Description
353123	Straight, 3/8" (8 mm) jaw, 1-3/4" (4.5 cm)
353125	Straight, 1/2" (12 mm) jaw, 1-7/8" (5 cm)
353127	Straight, 3/4" (19 mm) jaw, 2" (5 cm)
353124	Angled, 3/8" (8 mm) jaw, 1-5/8" (4 cm)
353126	Angled, 1/2" (12 mm) jaw, 1-3/4" (4.5 cm)
353128	Angled, 3/4" (19 mm) jaw, 1-7/8" (5 cm)



353128

WYLIE LUMBAR BULLDOG® CLAMP



353075

Jaw is more gently curved than the standard DeBakey® Bulldog® Jaw. Designed for placement posterior to the aorta for occlusion of lumbar arteries.

Catalog #	Description
353075	7/8" (2 cm) jaw, 3" (7.5 cm)

BULLDOG® AND MICRO VESSEL CLAMPS

Micro Vessel Clamps

BRACHIAL LARGE VESSEL CLIPS



24 mm blade, 2.5 mm wide at tip. Overall length 1.61" (4 cm).

Catalog #	Description
065110	Straight
065111	Tapered

BULLDOG® CLAMP APPLYING FORCEPS



This long clamp makes fast application and removal of any Bulldog® Clamp an easy task, even in the most inaccessible spot.

Catalog #	Description
353035	9-1/2" (24 cm)

KLEINERT-KUTZ MICRO VESSEL CLIPS



065105



065145

Catalog #	Description
065100	Straight blade, 1 x 3 mm, 0.34" (8.5 mm)
065105	Straight blade, 1 x 5 mm, 0.40" (10 mm)
065125	Angled blade, 1 x 5 mm
065145	Curved blade, 1 x 6 mm

BULLDOG® AND MICRO VESSEL CLAMPS

Micro Vessel Clamps

TEMPORARY OCCLUSION CLIPS



Catalog #	Description
065108	7 x 2 mm blade
065109	12 x 2 mm blade

LOUISVILLE MICRO VESSEL APPROXIMATOR WITH CLIPS



With suture staying frame.

Catalog #	Description
065172	1.5 x 8 mm blades, 1/2" (12.5 mm) bar
065173	1 x 5 mm blades, 7/16" (11 mm) bar

KLEINERT-KUTZ MICRO CLIP APPLYING FORCEPS



Catalog #	Description
065155	2-1/2" (6.5 cm)

BULLDOG® AND MICRO VESSEL CLAMPS

Micro Vessel Clamps

RIZZUTI ANGLED MICRO CLIP APPLYING FORCEPS



Applier opens approximator simultaneously or individually.

Catalog #	Description
065175	5-1/2" (14 cm)

SCHWARTZ MICRO-BULLDOG® CLAMPS



For temporary occlusion of minor vessels. 1" (2.5 cm).

Catalog #	Description
353041	Straight
353042	Slight curve
353043	Acute curve

SCHWARTZ CLAMP HOLDING FORCEPS



Catalog #	Description
353040	7-1/2" (19 cm)

BULLDOG® AND MICRO VESSEL CLAMPS

Micro Vessel Clamps

RENAL PERFUSION CLAMPS



353140



353142

- Designed to reduce risk of intimal damage.
- Eliminates necessity for artery cannulation.
- Minimizes disadvantages of en bloc perfusion and preservation.

Catalog #	Description
353140	10 mm x 15 mm DeBakey®-type Jaw (Pediatric, single renal artery)
353142	10 mm x 25 mm DeBakey®-type Jaw (Adult, multiple renal arteries)

BULLDOG® AND MICRO VESSEL CLAMPS

Micro Vessel Clamps

MICRO-ANEURYSM BULLDOG® CLIPS AND APPLIERS



357580



357581



357582



357583



357586

Closing force is approximately 170 grams.
Recommended for single use only.

Catalog #	Description
357580	Straight, 7 mm
357581	Straight, 8 mm
357582	Angled, 9 mm Slight curve, 9 mm
357583	Applying forceps for Micro-Aneurysm Clips,
357586	7-1/2" (19 cm)

Caution: These clips should be compressed only when properly seated in the appropriate applying forceps, never with the fingers. If compression of a clip is started but the clip is not used, it must be discarded and a new clip used.

BULLDOG® AND MICRO VESSEL CLAMPS

Micro Vessel Clamps

MINI-ANEURYSM BULLDOG® CLIPS AND APPLIERS



357590



357591



357592



357593

Closing force is approximately 170 grams.
Recommended for single use only.

Catalog #	Description
357590	Straight, 4 mm
357591	Straight, 6 mm
357592	Curved, 7 mm
357593	Applying forceps for Mini-Aneurysm Clips, 8-1/4" (21 cm)

Caution: These clips should be compressed only when properly seated in the appropriate applying forceps, never with the fingers. If compression of a clip is started but the clip is not used, it must be discarded and a new clip used.

MICRO CLIP TRAY



065199

Catalog #	Description
065199	1-3/4" x 2-3/4" x 1/2" (4.5 x 7 x 1.5 cm)

VASCULAR CLAMPS

VASCULAR CLAMPS

DEBAKEY®-Type Clamp

A single row of finely serrated teeth opposing a double row, precisely crafted. Designed to deliver the most minimal trauma to tissue.

TIPS
Uniformly rounded. Virtually eliminates the potential for suture snag.

CREST
Prevents inadvertent pinching of tissue by providing an expansion area for the tissue.

RATCHETS
Provide the finite control necessary in cardiovascular thoracic surgery. They are designed to furnish the precise increments of pressure desired. Offered in 1 x 7, 1 x 9, 1 x 11 steps.

SHANKS
Tempered to eliminate rigidity while providing proportionate softness.

FINGER RINGS
Comfortably sized.

JAWS
Jaws on Clamps are set with precision. Coordination of ratchet length and jaw setting provides the precise amount of required compression.

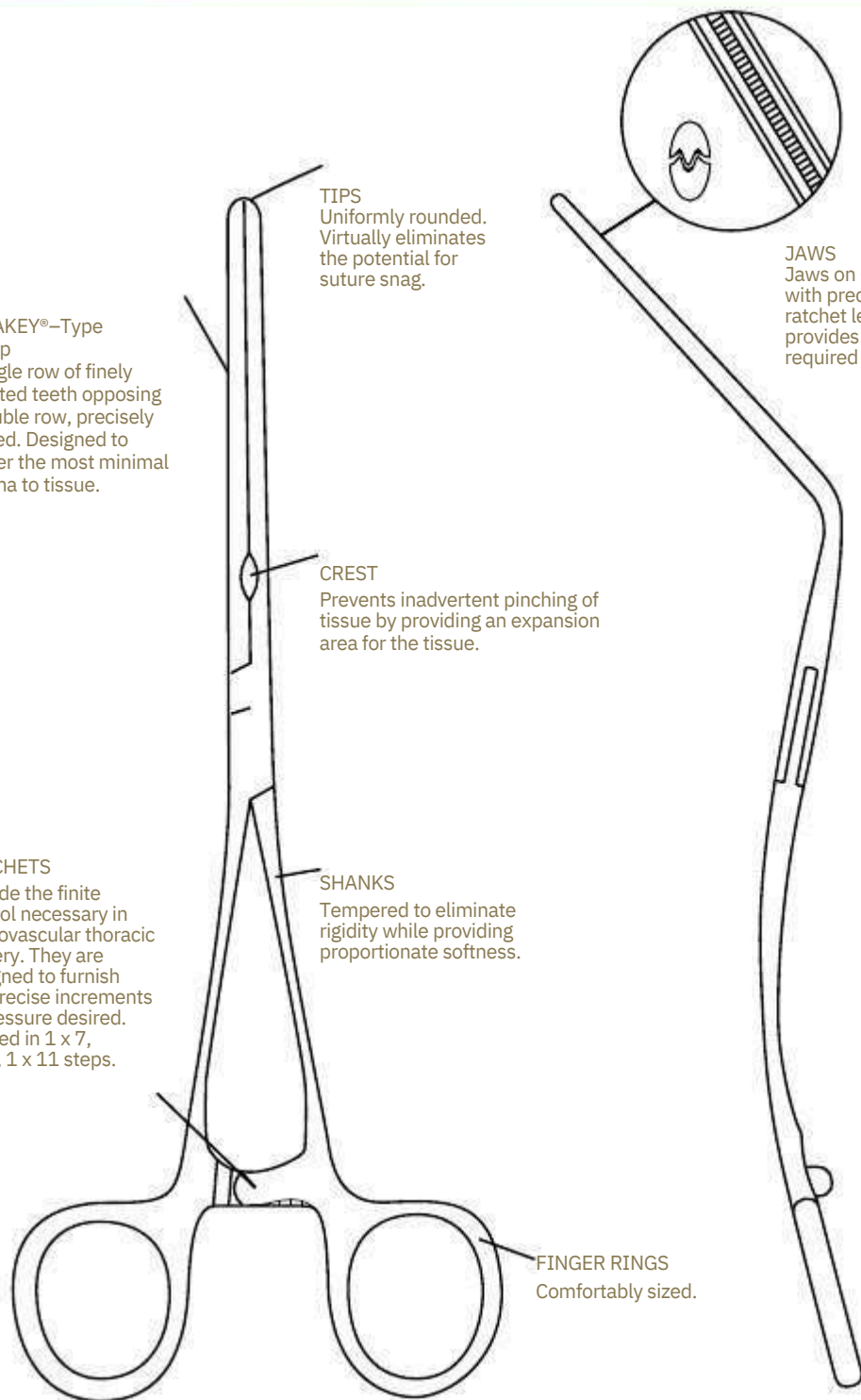

VASCULAR CLAMPS

Types of Jaws Used in Cardiovascular Clamps

JAW CROSS SECTIONS

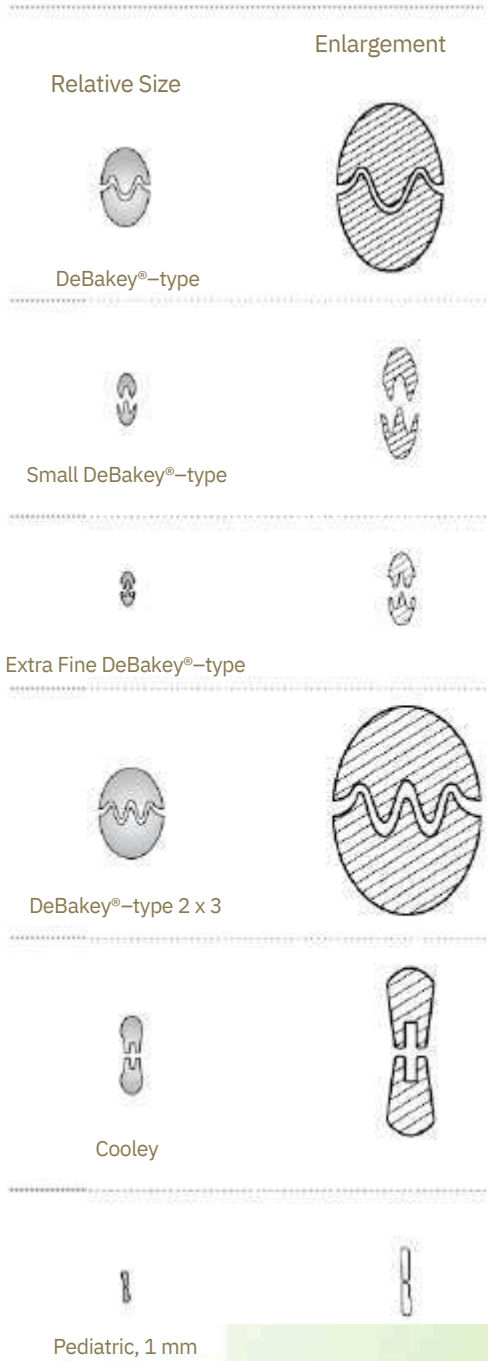

A single row of serrated teeth opposing a double row. The most commonly used jaw design (and most imitated). Proven through many years' use at hospitals throughout the world on adult peripheral vascular, aortic occlusion and partial occlusion clamps.

A small version of the DeBailey®-type Jaws used on most bulldogs, vascular tissue forceps and numerous pediatric clamps.

The smallest size DeBailey®-type Jaws used on many new pediatric and adult peripheral vascular clamps, bulldogs and forceps.

Double row of serrated teeth opposing a triple row. This modified version of the DeBailey®-type Serration, having a broader clamping surface, is used on large clamps for aortic cross clamping and on diseased and calcified arteries. Clamps with the 2 x 3 serration are also used frequently in general surgery as bowel clamps.

Two opposing rows of atraumatic teeth. Designed especially for surgery on infants and children as the jaws grasp vessels firmly. Also available on a limited group of adult vascular clamps.

Narrow, single row of opposing teeth. Designed for neonatal vascular surgery, these clamps have also proven of value in adult surgery of the carotid femoral and popliteal arteries and for creating AV fistulas.

VASCULAR CLAMPS

Pediatric Clamps, 1 mm Jaw

CASTANEDA PEDIATRIC CLAMPS

Versatile, multipurpose clamps designed for neonatal use. Long, slightly curved handles, 1 x 6 ratchets.

Catalog #	Description
357191	Long, small jaw, 1 mm thick, 9/16" (1.5 cm), spring handle, 1 x 6 ratchets, 6" (15 cm)
357192	Long, large jaw, 1 mm thick, 3/4" (2 cm), spring handle, 1 x 6 ratchets, 6" (15 cm)

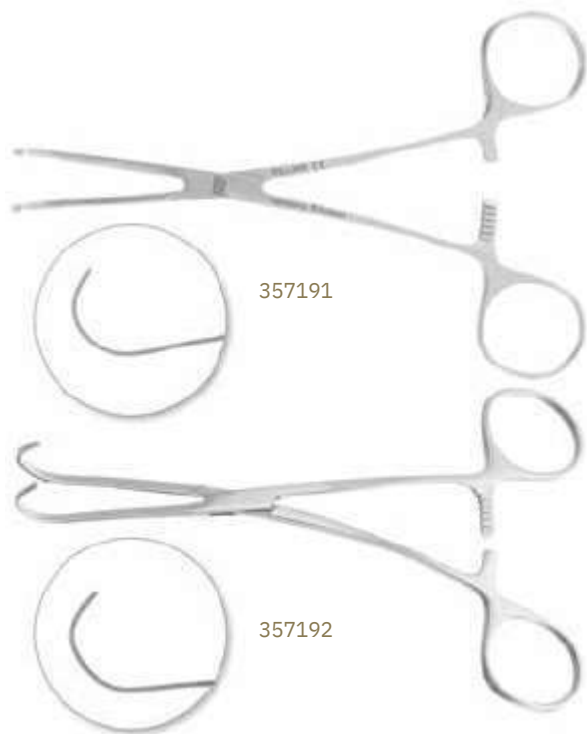

LONG 1 MM PEDIATRIC CLAMPS

To determine the overall length of our vascular clamps, measure the handle type and the jaw type and add measurements together to obtain the overall size. Blades are scribed from the tips in 5 cm graduations.

Catalog #	Description
357200	Straight handles, 6-1/8" (15.5 cm)
357202	Straight handles, 6-1/8" (15.5 cm)
357262	Angled handles, 5-5/8" (14.5 cm)
357270	Angled handles, 5-7/8" (15 cm)

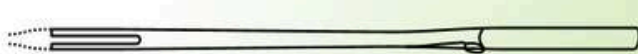

357200

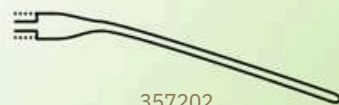

357202

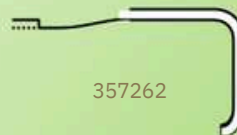

357262

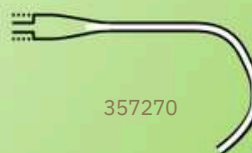

357270

VASCULAR CLAMPS

Pediatric Clamps, 1 mm Jaw

SHORT 1 MM PEDIATRIC CLAMPS

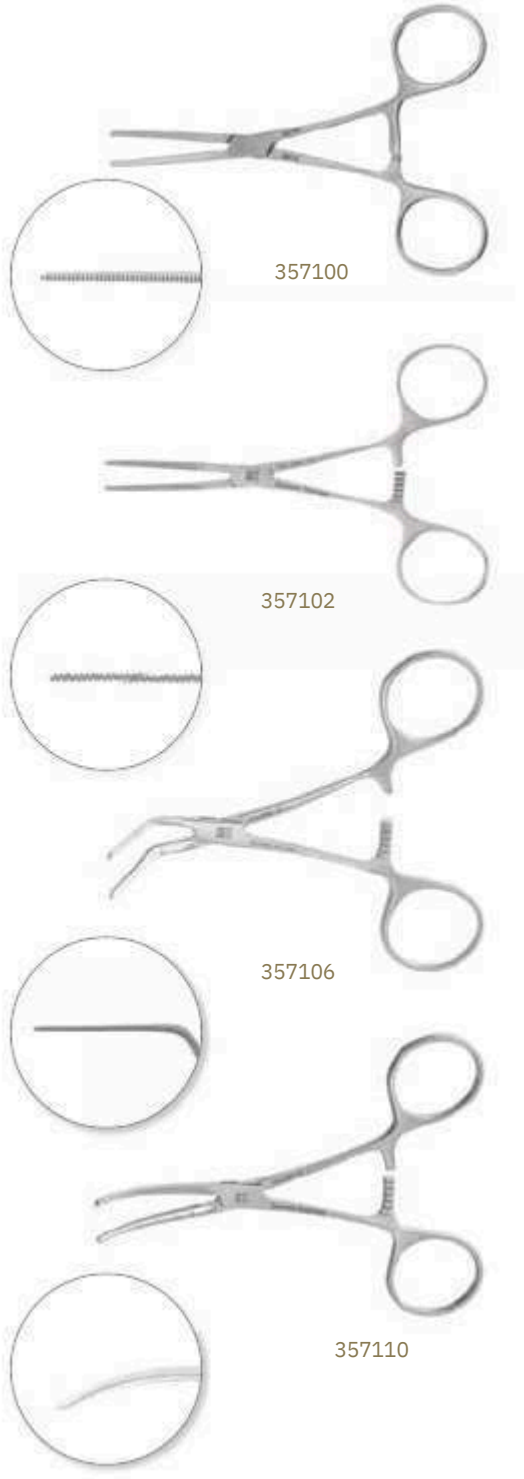

Catalog #
357100
357102
357106
357110

Description
Straight handles, 4-5/8" (12 cm)
Straight handles, 4-1/2" (11.5 cm)
Straight handles, 4" (10.5 cm)
Straight handles, 4-1/2" (11.5 cm)

VASCULAR CLAMPS

Pediatric Clamps, 1.5 mm Jaw

DEBAKEY® COARCTATION CLAMPS

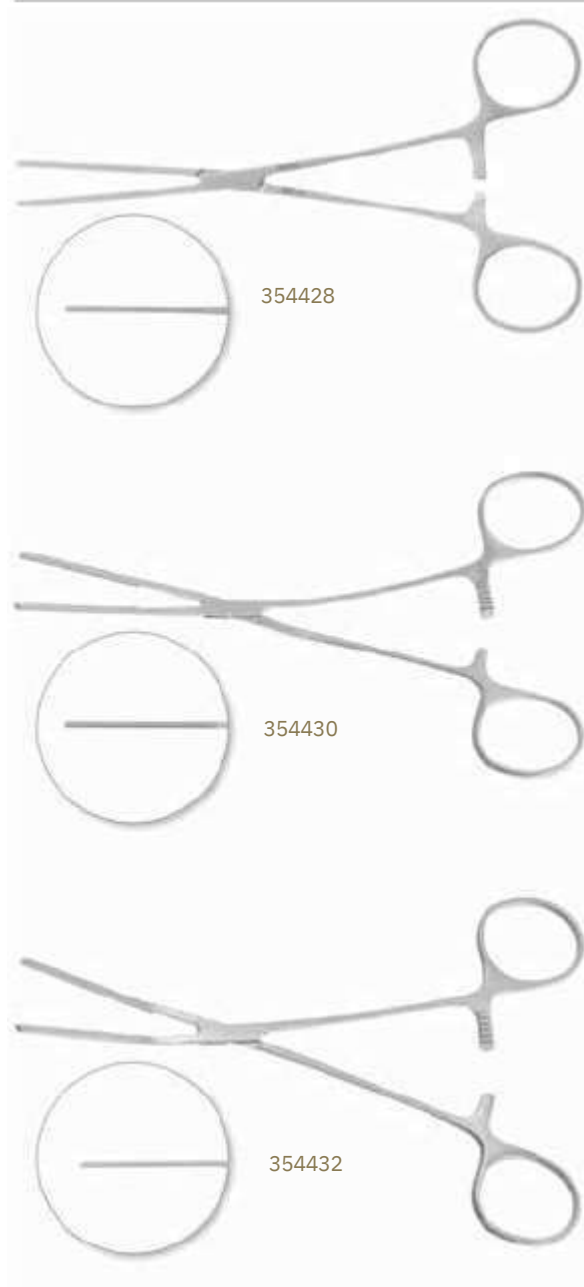

Catalog #
 354428
 354430
 354432

Description
 Straight, 6-3/8" (16 cm)
 Angled shank, 6-1/4" (16 cm)
 Jaw angled 15 degrees, 6-1/2" (16.5 cm)

VASCULAR CLAMPS

Pediatric Clamps, 1.5 mm Jaw

DEBAKEY® PARTIAL OCCLUSION CLAMPS



354488



354490

Catalog #	Description
354488	Small, 4-3/8" (11 cm)
354490	Medium, 4-3/8" (11 cm)
354494	Large, 6-1/4" (16 cm)
354496	Small, extra-long, 6-5/8" (17 cm)

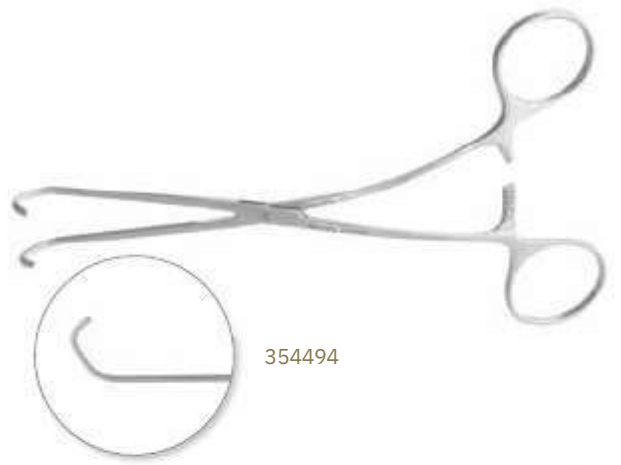

354494

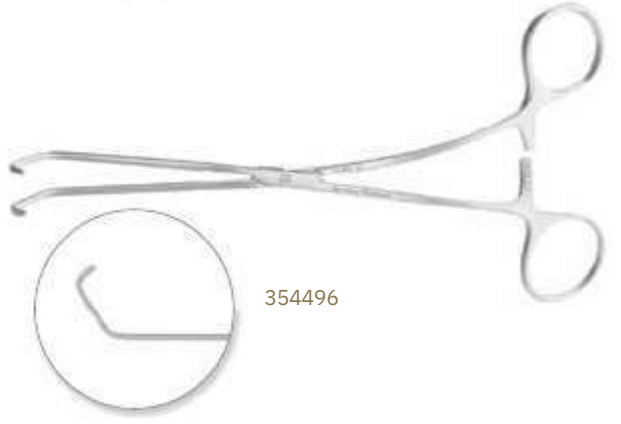

354496

VASCULAR CLAMPS

Pediatric Clamps, 1.5 mm Jaw

DEBAKEY® SPOON CLAMPS



Catalog #
354420
354422
354424

Description
Small spoon, 6-1/4" (16 cm)
Small spoon, angled, 5-3/4" (14.5 cm)
Large spoon, 6-1/8" (15.5 cm)

VASCULAR CLAMPS

Pediatric Clamps, 1.5 mm Jaw

DEBAKEY® MULTIPURPOSE VASCULAR CLAMPS



Catalog #	Description
354434	Angled 30 degrees, jaw length 20 mm, 5-3/4" (14.5 cm)
354436	Angled 45 degrees, jaw length 20 mm, 5-1/2" (14 cm)
354438	Angled 60 degrees, jaw length 20 mm, 5-3/8" (13.5 cm)

VASCULAR CLAMPS

Pediatric Clamps, 1.5 mm Jaw

DEBAKEY® MULTIPURPOSE VASCULAR CLAMPS LONG



Catalog #
354442
354444
354446

Description
Angled 30 degrees, 6-1/2" (16.5 cm)
Angled 45 degrees, 6-1/8" (15.5 cm)
Angled 60 degrees, 5-3/4" (14.5 cm)

VASCULAR CLAMPS

Pediatric Clamps, 1.5 mm Jaw

DEBAKEY® PEDIATRIC AND ADULT VASCULAR CLAMPS



Catalog #	Description
354400	Small, angled 45 degrees, 5/8" (1.5 cm) jaw, 3-7/8" (10 cm)
354402	Medium, angled 45 degrees, 4-1/8" (10.5 cm)
354404	Large, straight, 5-1/2" (14 cm)
354406	Angled 15 degrees, 5-1/4" (13.5 cm)

VASCULAR CLAMPS

Pediatric Clamps, 1.5 mm Jaw

DEBAKEY® PEDIATRIC AND ADULT VASCULAR CLAMPS

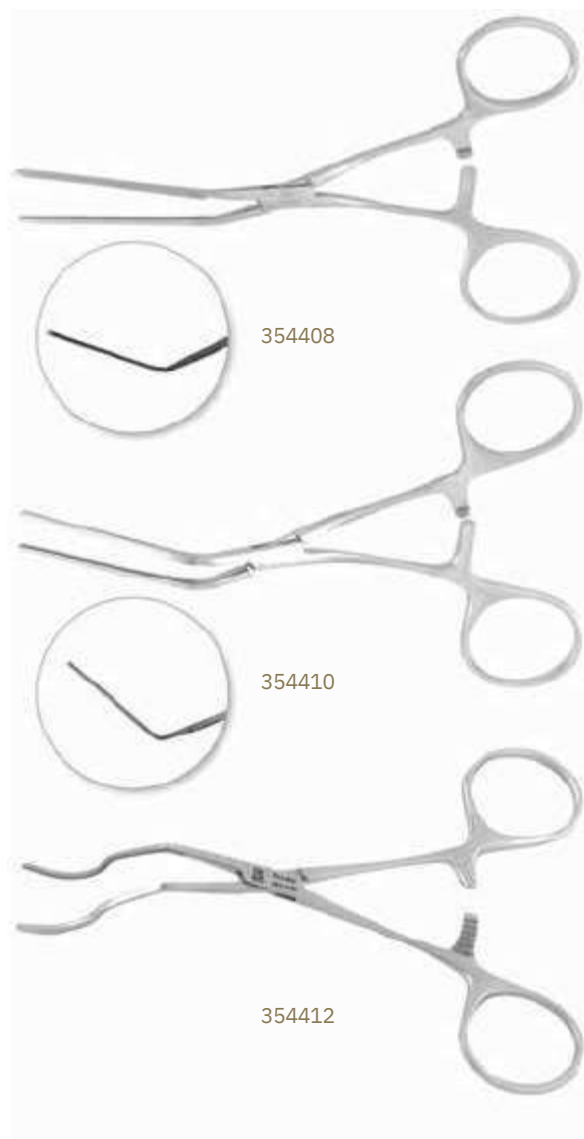

Catalog #	Description
354408	Angled 45 degrees, 1-3/8" (3.5 cm) jaw, 4-7/8" (12.5 cm)
354410	Angled 60 degrees, 1-5/8" (4 cm) jaw, 4-3/8" (11 cm)
354412	Angled 90 degrees, 1-7/8" (4.8 cm) tip length, 3-3/4" (9.5 cm)

VASCULAR CLAMPS

Pediatric Clamps, 1.5 mm Jaw

DEBAKEY® PATENT DUCTUS CLAMPS



Catalog #	Description
354414	Straight, 1.7 mm tip width, 6" (15 cm)
354416	Angled 20 degrees, 1.7 mm tip width, 6" (15 cm)

DEBAKEY® PEDIATRIC AND ADULT VASCULAR CLAMPS



Catalog #	Description
354448	Large, angled 90 degrees, 5-1/4" (13 cm)

VASCULAR CLAMPS

Pediatric Clamps, 1.5 mm Jaw

DEBORAH-CASTANEDA PARTIAL OCCLUSION CLAMPS

Jaw blades calibrated at 5 mm intervals.

Catalog #	Description
354456	Small, 25 mm jaw, 4-1/2" (11.5 cm)
354458	Medium, 18 mm jaw, 5-5/8" (14 cm)
354460	Large, 21 mm jaw, 5-3/4" (14.5 cm)
354462	Extra-large, 26 mm jaw, 5-7/8" (15 cm)



VASCULAR CLAMPS

Pediatric Clamps, 1.5 mm Jaw

DEBORAH-CASTANEDA PERIPHERAL VASCULAR CLAMPS

Jaw blades calibrated at 5 mm intervals.



Catalog #	Description
354450	Angled 30 degrees, 30 mm jaw, 4-3/4" (12 cm)
354452	Angled 50 degrees, 30 mm jaw, 4-5/8" (11.5 cm)
354454	Angled 90 degrees, 30 mm jaw, 3-3/4" (9.5 cm)

VASCULAR CLAMPS

Pediatric Clamps, 1.5 mm Jaw

DERRA PARTIAL OCCLUSION CLAMPS

Catalog #	Description
354464	Short, small, 10 mm jaw, 4-3/8" (11 cm)
354466	Short, medium, 16 mm jaw, 4-3/8" (11 cm)
354468	Short, large, 28 mm jaw, 4-5/8" (11.5 cm)
354470	Small, curved handle, 17 mm jaw, 4-3/8" (11 cm)
354472	Medium, curved handle, 22 mm jaw, 4-3/4" (12 cm)

VASCULAR CLAMPS

Pediatric Clamps, 1.5 mm Jaw

DERRA PARTIAL OCCLUSION CLAMPS



Catalog#	Description
354474	Large, curved handle, 25 mm jaw, 4-1/2" (11.5 cm)
354476	Deep, small, curved handle, 17 mm jaw, 5-5/8" (14 cm)
354482	Deep, small, extra-long, 18 mm jaw, 7" (18 cm)
354484	Deep, medium, extra-long, 22 mm jaw, 7" (18 cm)
354486	Deep, large, extra-long, 25 mm jaw, 7-1/4" (18.5 cm)



VASCULAR CLAMPS

Pediatric Clamps, 1.5 mm Jaw

REPLOGIE PEDIATRIC AORTA CROSS CLAMP

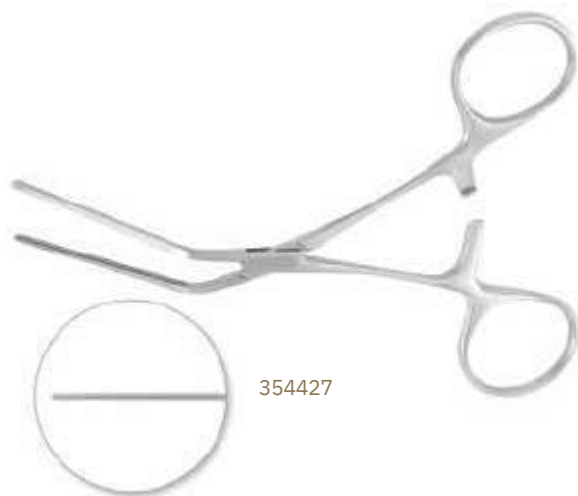

Catalog #
354427

Description
Angled 60 degrees, 48 mm jaw, 4-5/8" (12 cm)

Pediatric Clamps, 2 mm Jaw

BECK MINIATURE PEDIATRIC AORTIC CLAMP



Catalog #
354750

Description
Jaw length (A) 1" (2.5 cm), (A) depth 1/4" (5 cm),
overall length 7" (18 cm)

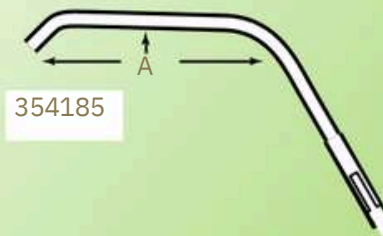

VASCULAR CLAMPS

Pediatric Clamps, 2 mm Jaw

BECK-TYPE VESSEL CLAMPS



Small, acutely curved DeBakey®-type Jaws.

Catalog #	Description
354190	Small, 21 mm jaw, 6" (15 cm)
354191	Large, 32 mm jaw, 6-1/2" (16.5 cm)

VASCULAR CLAMPS

Pediatric Clamps, 2 mm Jaw

DEBAKEY® ACUTELY CURVED CLAMPS



Jaws curve on 1-3/4" (4.5 cm) radius, entire length of jaws contain DeBakey®-type Serrations.

Catalog #	Description
354729	6-3/4" (17 cm) Jaws are larger than 354729
354730	Length (B) 2-3/4" (7 cm) Length (A) 1-3/4" (4.5 cm) Depth (A) 3/4" (2 cm) Overall length 6-7/8" (17.5 cm)

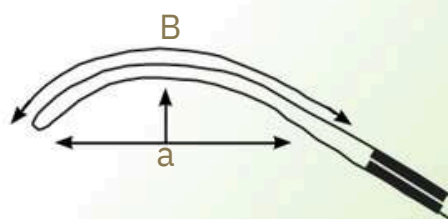

DEBAKEY® MINIATURE ANASTOMOSIS CLAMP



Catalog #	Description
354435	Small jaw, 6-1/2" (16.5 cm)

VASCULAR CLAMPS

Pediatric Clamps, 2 mm Jaw

DEBAKEY® PEDIATRIC MULTIPURPOSE CLAMPS



DeBaKEY®-type Jaw, spring handle, 1 x 7 ratchets.

Catalog #	Description
354735	Angled 30 degrees, jaw 3/4" (19 mm) long past angle, 6-3/4" (17 cm)
354737	Angled 60 degrees, jaw 1-1/4" (32 mm) long past angle, 6-1/4" (16 cm)
354739	Angled 90 degrees, jaw 1-1/2" (37 mm) long past angle, 6" (15 cm)

VASCULAR CLAMPS

Pediatric Clamps, 2 mm Jaw

GLOVER CURVED MINIATURE PEDIATRIC CLAMP



Catalog #	Description
354755	Slightly curved jaws 1/2" (1.2 cm) long, 7-1/8" (18 cm)

354755

MINIATURE SATINSKY REYNOLDS CLAMPS

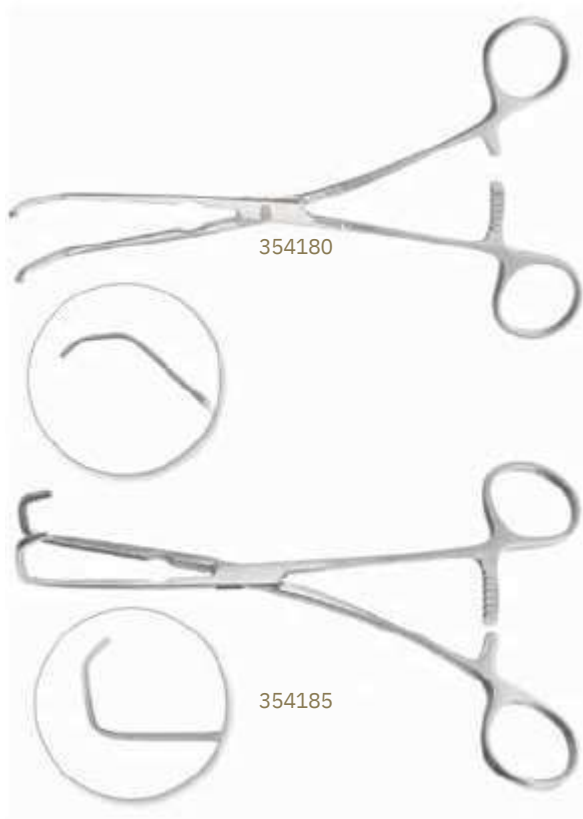

Reynolds-type clamps, baby size. These miniature models of the Satinsky Clamp have DeBakey -type Jaws and are made in two jaw angles.

Catalog #	Description
354180	Angled 50 degrees, small jaw, (A) length 1" (2.5 cm), (A) depth 1/4" (6 mm), 7-1/4" (18.5 cm)
354185	Angled 85 degrees, small jaw, (A) length 1-1/4" (3 cm), (A) depth 1/4" (6 mm), 6-3/4" (17 cm)

354180

354185

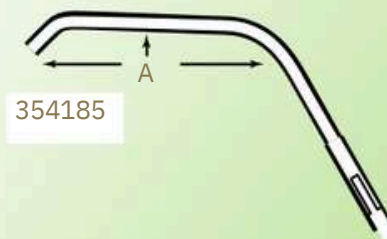

354185

VASCULAR CLAMPS

Pediatric Clamps, 2 mm Jaw

MINIATURE PEDIATRIC CLAMPS



Miniatures are all the same general size (approximately 4-1/4" (11 cm) to center of box lock) and weight. They are considerably lighter than "standard adult" instruments of the same model. The jaws are approximately 2 mm wide with medium size DeBakey®-type Serration.

Catalog #	Description
354720	Patent Ductus, straight, 2" (5 cm) jaws, 6-3/4" (17 cm)
354721	Patent Ductus, straight, 1-7/8" (4.5 cm) jaws, 6-3/8" (16 cm)
354722	Coarctation, straight, 2-1/2" (6 cm) jaws, 7-1/8" (18 cm)
354723	Coarctation, angled, 2-3/8" (6 cm) jaws, 7" (17.5 cm)
354724	Spoon shape, 1-3/4" (4.5 cm) jaws, 7-1/8" (18 cm)

VASCULAR CLAMPS

Pediatric Clamps, Cooley-Type Jaw

COOLEY CLAMPS FOR PEDIATRIC CARDIOVASCULAR SURGERY

These clamps are designed especially for surgery in infants and small children. They have specially set ratchets to permit gradual application and release of the clamps.

Cooley-type Jaws. A double row of fine atraumatic

teeth are arranged in opposing rows to grasp the vessel. The teardrop shape of the jaws allows for maximum length of divided vessel for suturing (as patent ductus arteriosus).

Calibrations. Jaws are engraved at 5 mm intervals to facilitate accurate measurements. The calibration is on the outer sides of the jaws on cross clamps and on the anterior surface of partial occlusion clamps.

The Cooley Clamps are all of the same general size and weight. Tension is carefully calculated to be in proportion to jaw length, shape and intended use. Length is approximately 4-1/4" (10.8 cm) to center of box-lock. Constructed of dull, non-glare finished stainless steel. Shafts or arms of Cooley Clamps are of three different shapes — straight, angled or curved as shown in diagram. Jaw shapes are varied as shown, and are calibrated starting from distal tip toward box-lock or from center point of jaw, proceeding in both directions.

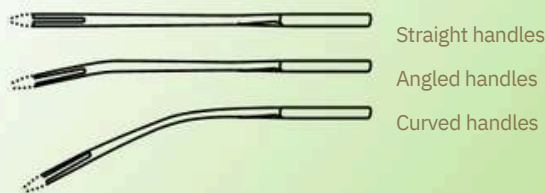
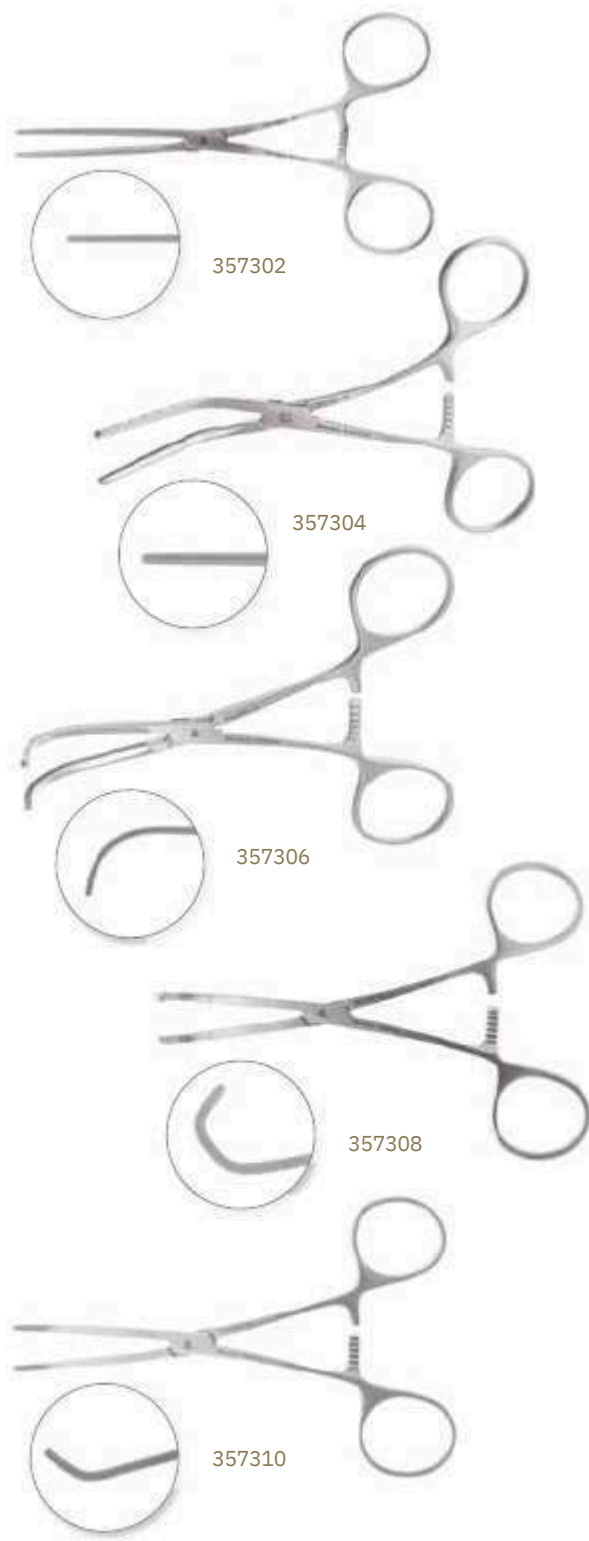

Spring handle, 1 x 6 ratchets.

Catalog#	Description
357302	Straight jaw, angled shanks, 5-1/8" (13 cm)
357304	Angled jaw, curved shanks, 5" (12.5 cm)
357306	Curved 3/4" (19 mm) jaw, straight shanks, 4-5/8" (11.5 cm)
357308	Partial occlusion jaw, curved shanks, 4-5/8" (11.5 cm)
357310	Carotid jaw, curved shanks, 4-3/4" (12 cm)

VASCULAR CLAMPS

Pediatric Clamps, Cooley-Type Jaw

BECK-TYPE VESSEL CLAMP



354810

Small, acutely curved jaws calibrated on anterior surface from center point outward.

Catalog #	Description
354810	Straight handles, 1" (2.5 cm) jaw, 6-1/8" (15.5 cm)

COOLEY ANASTOMOSIS CLAMPS



354125

Jaws are calibrated on the anterior surface from center point outward. This miniature vascular clamp is designed for partial occlusion of a major vessel (aorta, inferior vena cava, carotid artery, etc.) where total occlusion may be undesirable. Calibrations at 5 mm intervals on the jaws are useful in aortico-pulmonary anastomosis in infants and children with tricuspid atresia or Tetralogy of Fallot. Lightweight, calibrated jaws 3/4" (2 cm) with Cooley serration.



354845

Catalog #	Description
354125	Spring handle, 1 x 7 ratchets, 7-1/8" (18 cm)
354845	1.5 mm extra-fine DeBakey®-type Jaws, spring handle, 1 x 7 ratchets, 7-1/8" (18 cm)

VASCULAR CLAMPS

Pediatric Clamps, Cooley-Type Jaw

COOLEY CLAMPS

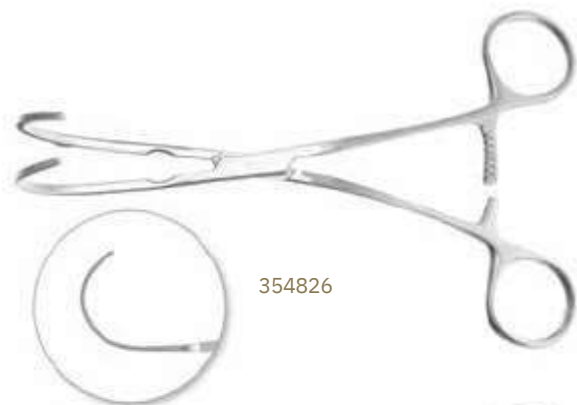

354826

Acutely curved clamps. Jaws calibrated on anterior surface from center point outward. Angled shafts.

Catalog #	Description
354826	Medium clamp, full length Cooley jaw serrations, 1-1/2" (3.8 cm), 6-5/8" (17 cm)
354827	Large clamp, full length Cooley jaw serrations, 1-3/4" (4.5 cm), 6-3/4" (17 cm)



354827

COOLEY CLAMPS FOR PEDIATRIC AND INFANT CARDIOVASCULAR SURGERY



354830

Double angle jaws calibrated on anterior surface from center point outward. Angled shafts.

Catalog #	Description
354830	Angled 90 degrees, small jaws, 6-3/4" (17 cm)

VASCULAR CLAMPS

Pediatric Clamps, Cooley-Type Jaw

COOLEY PEDIATRIC CARDIOVASCULAR CLAMPS

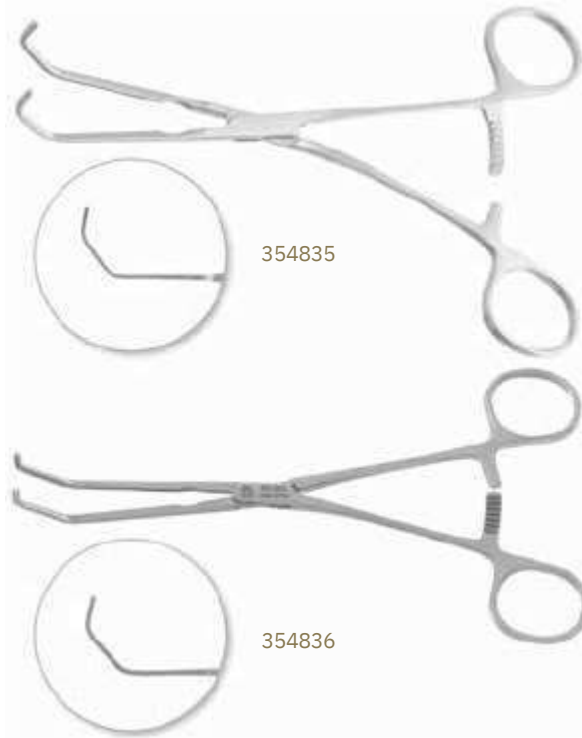

Catalog #

354835

354836

Description

Angled shafts, small, double angled 60 degree calibrated jaw, 7-1/8" (18 cm)

Angled shafts, large, double angled 60 degree calibrated jaw, 7-1/8" (18 cm)

354835

354836

VASCULAR CLAMPS

Pediatric Clamps, Cooley-Type Jaw

COOLEY PEDIATRIC DERRA CLAMPS

Slightly curved shaft, spring handle, 1 x 7 ratchets.

Catalog #	Description
354815	Small, calibrated 3/4" (2 cm) jaw, 7" (18 cm)
354816	Medium, calibrated 1-1/8" (3 cm) jaw, 7" (18 cm)
354817	Large, calibrated 1-1/8" (3 cm) jaw, 7-1/8" (18 cm)



VASCULAR CLAMPS

Pediatric Clamps, Cooley-Type Jaw

COOLEY PEDIATRIC MODIFIED ANASTOMOSIS CLAMP



Catalog #
354847

Description
30 degree side angle, calibrated 5/8" (1.5 cm) jaw,
spring handle, 1 x 7 ratchets, 7-1/8" (18 cm)

354847

COOLEY PEDIATRIC MULTIPURPOSE CLAMPS

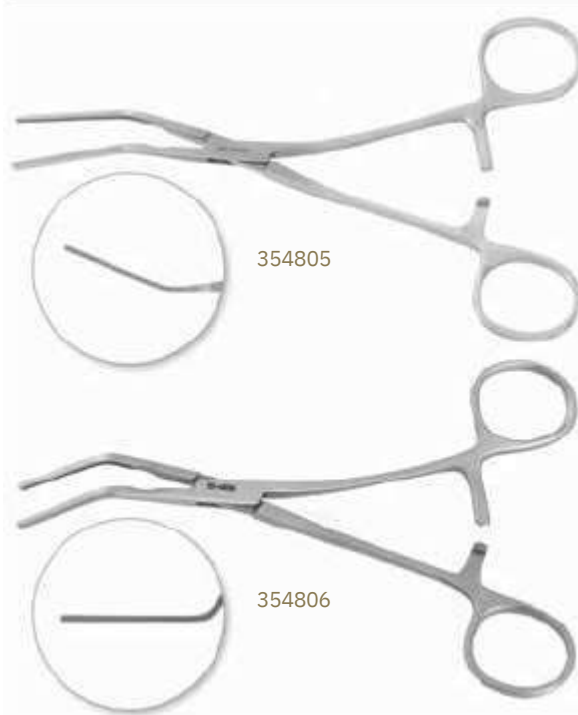

Long, angled shanks, spring handle, 1 x 7 ratchets.

Catalog #
354805

Description
30 degree angled, calibrated 3/4" (2 cm) jaw,
6-3/4" (17 cm)

354806

60 degree angled, calibrated 1-1/4" (3.5 cm) jaw,
6-1/2" (16.5 cm)

354807

90 degree angled, calibrated 1-1/2" (4 cm) jaw,
5-3/4" (14.5 cm)

354805

354806

VASCULAR CLAMPS

Pediatric Clamps, Cooley-Type Jaw

COOLEY PEDIATRIC PATENT DUCTUS CLAMPS

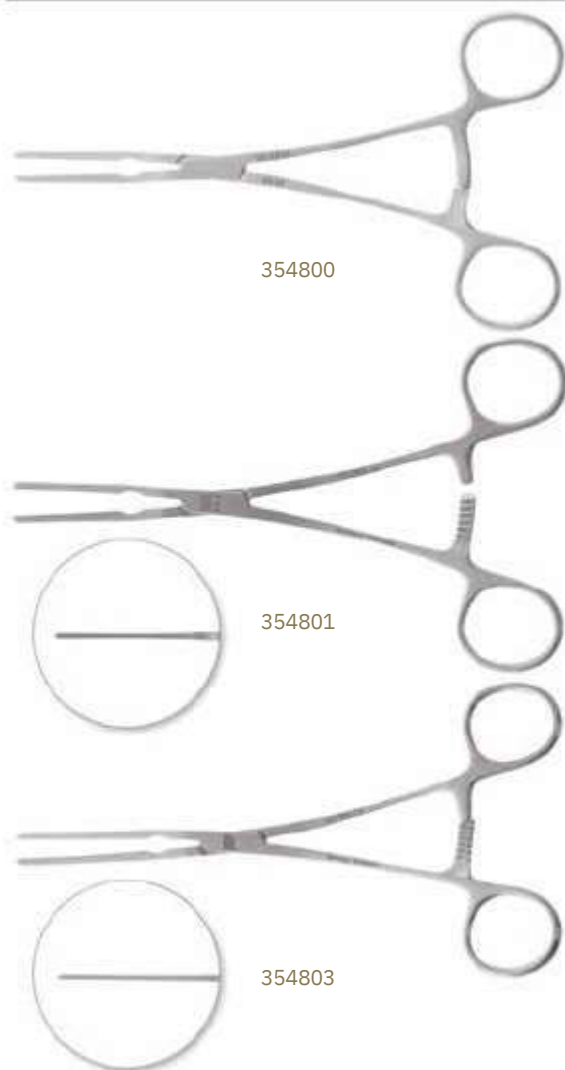

Spring handle, 1 x 7 ratchets.

Catalog #	Description
354800	Straight, calibrated jaw, straight shanks, 6-3/4" (17 cm)
354801	Straight, calibrated jaw, angled shanks, 6-1/2" (16.5 cm)
354802	Straight, calibrated jaw, straight shanks, 7" (18 cm)
354803	Straight, calibrated jaw, angled shanks, 7" (18 cm)
354804	Curved, calibrated jaw, straight shanks, 7-1/4" (18.5 cm)

COOLEY PEDIATRIC PATENT DUCTUS CLAMPS



Catalog #	Description
354808	Spoon-shaped, 5 mm calibrated jaws, straight handles, 7-1/8" (18 cm)

VASCULAR CLAMPS

Ring Handled Bulldog Clamps

DEBAKEY® RING HANDLE BULLDOG® CLAMPS

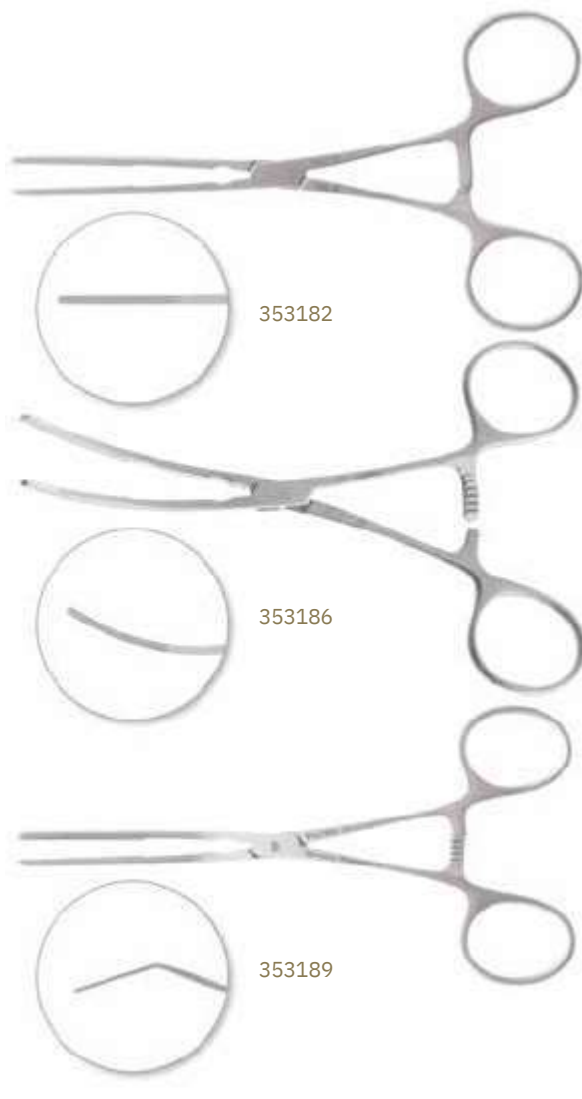

These short, sturdy clamps are intended for use in place of the longer sizes of “squeeze handle” bulldogs. They measure only 2-3/4" (7 cm) from the center point of the box lock to the end of the ring handles, averaging approximately 4-3/4" (12 cm) to 5-1/8" (13 cm) overall length depending on shape. Narrow DeBakey -type Jaws and spring handles provide firm, non-traumatizing grip.

Catalog #	Description
353182	Straight, 2-1/4" (5.5 cm) jaw, 5-3/8" (13.5 cm)
353186	Curved, 2-3/8" (6 cm) jaw, 5-3/8" (13.5 cm)
353189	Angled 45 degrees, jaws 1-3/16" (3 cm) past angle, curved shafts, 5-3/8" (13.5 cm)
353192	Angled 90 degrees, jaws 1-3/4" (4.5 cm) past angle, straight shafts, 4-1/8" (10.5 cm)
353195	"S"-shaped, curved, 2-1/2" (6.5 cm) jaws, long and curved shafts, 5-1/8" (13 cm)



VASCULAR CLAMPS

Ring Handled Bulldog Clamps

GREGORY MINIATURE VASCULAR CLAMPS



Very delicate, small vessel occlusion clamps, with DeBakey®-type Jaws 1.5 mm wide and LIFE-LOK® Box-Lock.

Catalog #	Description
353183	Straight, extra-light, 4-3/4" (12 cm)
353187	Curved, extra-light, 4-1/8" (10.5 cm)
353190	Angled 45 degrees, extra-light, 4-3/8" (11 cm)

VASCULAR CLAMPS

Carotid Clamps

CALMAN CAROTID BULLDOG® CLAMPS



Ring-tipped Bulldog® Clamps designed to lay out of the way while holding the shunt in place during carotid endarterectomy. For use with Javid Shunts.

Catalog #	Description
353080	Straight, with small ring, for use on the internal carotid artery superiorly holding the shunt in place, 5 mm ring, 3-1/2" (9 cm)
353085	Angled, with large ring, for use on the common carotid artery inferiorly, 8 mm ring, 3-3/4" (9.5 cm)

GREGORY INTERNAL CAROTID "SOFT" BULLDOG® CLAMP



Catalog #	Description
353077	5/8" (15 mm) distal tip, DeBakey®-type Jaw, 4-1/2" (11.5 cm)

GREGORY CAROTID ANGLED BULLDOG® CLAMP

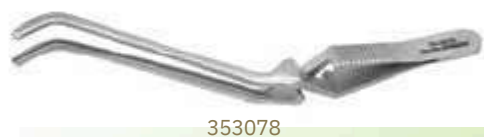

Catalog #	Description
353078	1/2" (12 mm) distal tip, DeBakey®-type Jaw, 4-1/2" (11.5 cm)

VASCULAR CLAMPS

Carotid Clamps

JAVID CAROTID SHUNT CLAMPS



Catalog #
353086
353087

Description
Large 6.0 mm ring, 7-3/8" (18.5 cm)
Small 3.5 mm ring, 6-7/8" (17.5 cm)

WYLIE CAROTID CLOSURE CLAMP



Catalog #
353569

Description
DeBakey-type Jaw with 1.7 mm wide tip,
6-1/8" (15.5 cm)

WYLIE CAROTID DISSECTING CLAMP



The endarterectomy dissection plane is developed just at the level of maximum disease. Once the plane has been developed to the depth of the artery, a special sharply curved clamp is used to continue the dissection to the opposite side of the arteriotomy. The Wylie Carotid Dissecting Clamp was designed for this purpose and may be preferred to a standard right angle clamp.

Catalog #
355196

Description
5-7/8" (15 cm)

VASCULAR CLAMPS

Carotid Clamps

WYLIE EXTERNAL CAROTID CLAMP



Catalog #
353570

Description
DeBakey-type Jaw, spring handle, 1 x 7 ratchets,
8" (20.5 cm)

WYLIE INTERNAL CAROTID CLAMP

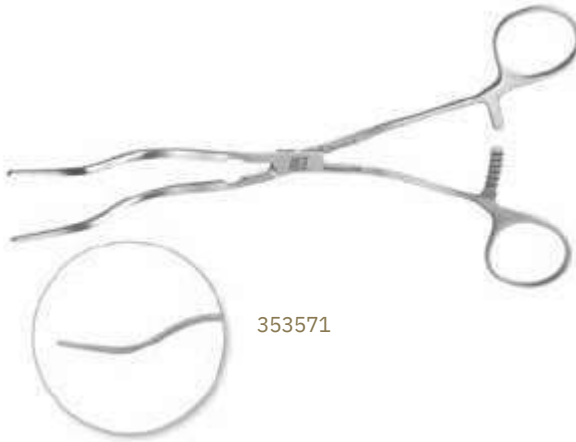

Catalog #
353571

Description
DeBakey-type Jaw, spring handle, 1 x 7 ratchets,
8-1/4" (21 cm)

WYLIE HYPOGASTRIC CLAMP



Catalog #
353657

Description
DeBakey-type Jaw, 9-5/8" (24.5 cm)

VASCULAR CLAMPS

Carotid Clamps

DOERING CAROTID END POINT MICRO RONGEUR FORCEPS



Spring handled rongeur forceps with a 2.5 mm cup to nip end point plaque during carotid endarterectomy.

Catalog #	Description
355198	7-1/4" (18.5 cm)

Carotid Clamps, 1 mm Jaw

CALMAN CLAMP



Catalog #	Description
357180	Angled handles, jaw 1" (2.5 cm) long and 1 mm thick, spring handle, 1 x 6 ratchets, 4-1/2" (11.5 cm)

EXAMPLE CLAMP



Catalog #	Description
357185	Angled handles, jaw 1" (2.5 cm) long and 1 mm thick, spring handle, 1 x 6 ratchets, 5-5/8" (14 cm)

VASCULAR CLAMPS

Carotid Clamps, 1 mm Jaw

KARTCHNER INTERNAL CAROTID CLAMP



Catalog #
357197

Description
Slightly curved handles, long jaw, 1 mm thick, spring handles, 1 x 6 ratchets, 6-3/8" (16.5 cm)

THOMPSON CLAMP



Catalog #
357194

Description
Slightly curved handles, long jaw, 1 mm thick, spring handle, 1 x 6 ratchets, 6-1/8" (15.5 cm)

VASCULAR CLAMPS

Carotid Clamps, 1.5 mm Jaw

KARTCHNER INTERNAL CAROTID CLAMP



Catalog #
357198

Description
Jaw length 10 mm, 6-1/4" (16 cm)

THOMPSON CAROTID CLOSURE CLAMP



Catalog #
357195

Description
Jaw length 22 mm, 5-3/4" (14.5 cm)

VASCULAR CLAMPS

Renal Clamps

CLEVELAND CLINIC RENAL CLAMPS



Specifically designed to access renal arteries. Jaws angled left and right. DeBaKey®-type Jaws.

Catalog #	Description
353531	Left large, 9-5/8" (24.5 cm)
353532	Right large, 9-5/8" (24.5 cm)
353533	Left baby renal clamp, extra-fine, 1.7 mm jaws, 6-1/2" (16.5 cm)
353534	Right baby renal clamp, extra-fine, 1.7 mm jaws, 6-1/2" (16.5 cm)



VASCULAR CLAMPS

Renal Clamps

DEBAKEY® RENAL ARTERY CLAMP



Catalog #
353515

Description
DeBaKey®-type Jaw, long, curved spring handle,
1 x 9 ratchets, 10-1/8" (25.5 cm)

STONEY SPLENO-RENAL SHUNT CLAMP

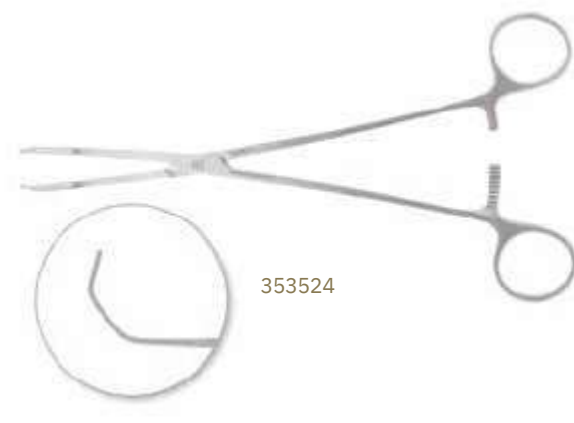

Catalog #
353524

Description
Long, extra-fine DeBaKey®-type Jaw, spring
handle, 1 x 9 ratchets, 9-1/4" (23.5 cm)

WIRTHLIN SPLENO-RENAL SHUNT CLAMP



Catalog #
353522

Description
Long, DeBaKey®-type Jaw, spring handle,
1 x 6 ratchets, 6-1/2" (16.5 cm)

VASCULAR CLAMPS

Femoral-Popliteal Clamps

DALE FEMORAL-POPLITEAL ANASTOMOSIS CLAMP



353528

Catalog #
353528

Description
DeBakey-type Jaw, spring handle, 1 x 7 ratchets,
7-3/8" (19 cm)

DALE FEMORAL-POPLITEAL CLAMPS

Spring handle, 1 x 7 ratchets.



353541

353542

Catalog #
353541
353542
353543

Description
Small, 7" (17.5 cm)
Medium, 7-1/8" (18 cm)
Large, 7-1/4" (18.5 cm)



353543

VASCULAR CLAMPS

Femoral-Popliteal Clamps

DEMOS TIBIAL ARTERY CLAMP



Specially angled in the plane of the handle, this clamp reduces the tendency to twist or distort a vessel in procedures requiring distal popliteal or tibial occlusion.

Catalog #
353568

Description
Straight, DeBakey®-type Jaw, 2-3/8" (6 cm) tip length,
2.1 mm tip width, angled shaft, 6-3/4" (17 cm)

Peripheral Vascular Clamps

DEBAKEY® "S" SHAPED PERIPHERAL VASCULAR CLAMP



Catalog #
353540

Description
Spring handles, 1 x 7 ratchets, 7-7/8" (20 cm)

VASCULAR CLAMPS

Peripheral Vascular Clamps

DEBAKEY® ANGLED PERIPHERAL VASCULAR CLAMP



Catalog #
353535

Description

Long, angled DeBakey -type Jaw, spring handles,
1 x 7 ratchets, 7-1/8" (18 cm)

DEBAKEY® AORTIC EXCLUSION CLAMP



Very light construction. Jaws and shafts curved to form
an acute "S" shape. Spring handles.

Catalog #
353545

Description

DeBakey-type Curved Jaws, 7-1/8" (18 cm)

VASCULAR CLAMPS

Peripheral Vascular Clamps

DEBAKEY® BAINBRIDGE VASCULAR CLAMPS

Light, delicate construction throughout with narrow, DeBakey®-type Jaws. Very useful as peripheral vascular clamps.

Catalog #	Description
353560	Straight, 4 cm jaws, overall length 7" (18 cm)
353562	Straight, 6 cm jaws, overall length 7-7/8" (20 cm)
353565	Curved, 4 cm jaws, overall length 7" (18 cm)
353567	Curved, 6 cm jaws, overall length 7-3/4" (19.5 cm)



VASCULAR CLAMPS

Peripheral Vascular Clamps

DEBAKEY® COARCTATION CLAMPS

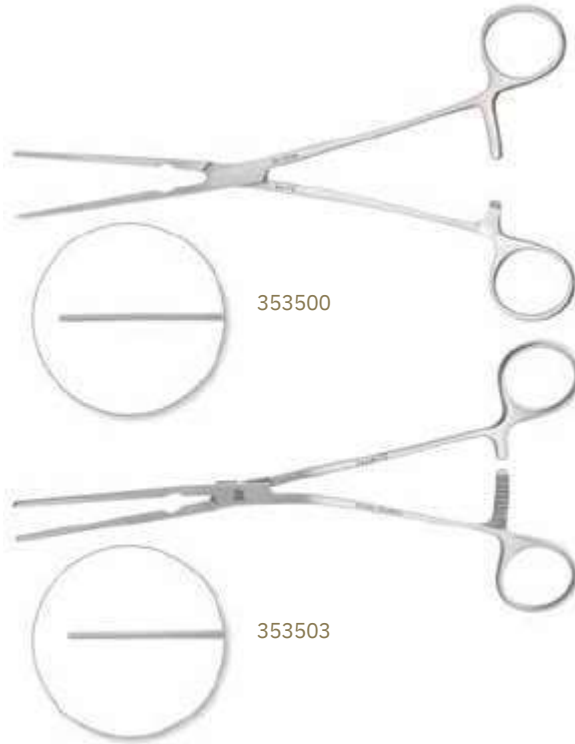

These are multipurpose clamps, full length but lightweight, with DeBakey®-type Jaws and spring handles. In addition to their use as Coarctation or Patent Ductus clamps, they are particularly useful for temporarily occluding renal arteries during cardiopulmonary by-pass. The special DeBakey -type Jaws are only 2.5 mm wide. Spring handles minimize trauma to vessels during temporary occlusion of arteries. Spring handle, 1 x 9 ratchets.

Catalog #	Description
353500	Long, straight, 3-1/8" (8 cm) jaw, 9" (23 cm)
353503	Long, angled, 3" (7.5 cm) jaw, 8-3/4" (22 cm)

DEBAKEY® CURVED PERIPHERAL VASCULAR CLAMP



Catalog #	Description
353550	Long, DeBakey®-type Jaw, spring handle, 1 x 7 ratchets, 6-3/4" (17 cm)

VASCULAR CLAMPS

Peripheral Vascular Clamps

DEBAKEY® PATENT DUCTUS CLAMPS

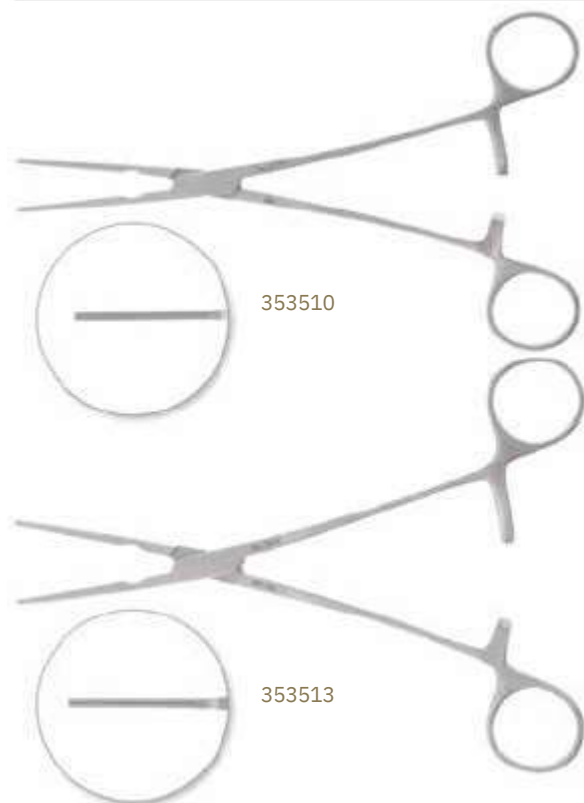

Long, DeBakey®-type Jaw, spring handle, 1 x 9 ratchets.

Catalog #	Description
353510	Straight, 2-1/4" (5.5 cm) jaw, 8-1/4" (21 cm)
353513	Angled, 2-3/8" (6 cm) jaw, 8-1/8" (20.5 cm)

VASCULAR CLAMPS

Peripheral Vascular Clamps

DERRA MINIATURE ANASTOMOSIS CLAMPS

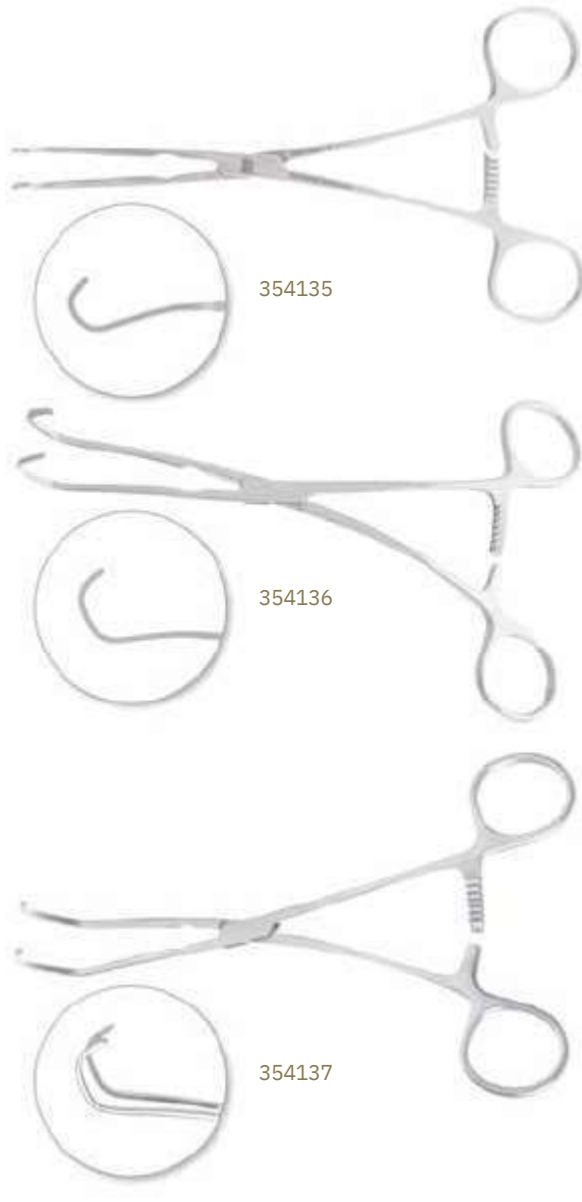

Long, DeBakey®-type Jaw, spring handle, 1 x 7 ratchets.

Catalog #	Description
354135	Small, 3/4" (2 cm) jaw, 6-7/8" (17.5 cm)
354136	Medium, 1-1/8" (3 cm) jaw, 7" (18 cm)
354137	Large, 1-1/4" (3 cm) jaw, 7-1/8" (18 cm)

VASCULAR CLAMPS

Peripheral Vascular Clamps

DIETHRICH CAVAL OCCLUSION CLAMP



Catalog #	Description
353536	9-3/4" (25 cm)

DIETHRICH CORONARY ARTERY CLAMP



A delicate clamp with handles designed for partial occlusion in coronary artery surgery.

Catalog #	Description
353700	Angled, DeBakey®-type Jaws, 1-1/4" (3 cm), 7-1/8" (18 cm)

VASCULAR CLAMPS

Peripheral Vascular Clamps

GREGORY PROFUNDA CLAMPS



DeBakey®-type Jaw, 1 x 6 ratchets.

Catalog #	Description
353494	Small, 2-1/4" (6 cm) extra-fine jaw, 4-3/4" (12 cm)
353495	Medium, 3-1/4" (8.5 cm) regular jaw, 6-1/8" (15.5 cm)
353496	Large, 4" (10 cm) jaw, 7" (18 cm)

VASCULAR CLAMPS

Peripheral Vascular Clamps

HENLY SUBCLAVIAN ARTERY CLAMP



Double angled DeBakey®-type Jaws specially designed to allow clamping an artery of medium size from beneath the artery, allowing an unobstructed working area anteriorly. It is extremely useful for occlusion of the subclavian artery exposed through a supraclavicular incision or for occlusion of the femoral artery exposed through a groin incision.

Catalog #	Description
353538	8-3/8" (21 cm)

LELAND JONES CLAMPS



Delicate jaws, 2.4 mm wide. DeBakey®-type Serrations. LIFE-LOK® Box-Lock. Versatile clamps which have been found useful in small bowel procedures.

Catalog #	Description
353490	Straight, 8-1/8" (20.5 cm)
353491	Angled 15 degrees, 8-1/8" (20.5 cm)
353492	Angled 30 degrees, 8" (20.5 cm)

VASCULAR CLAMPS

Peripheral Vascular Clamps

MITCHELL-ADAM MULTIPURPOSE CLAMP

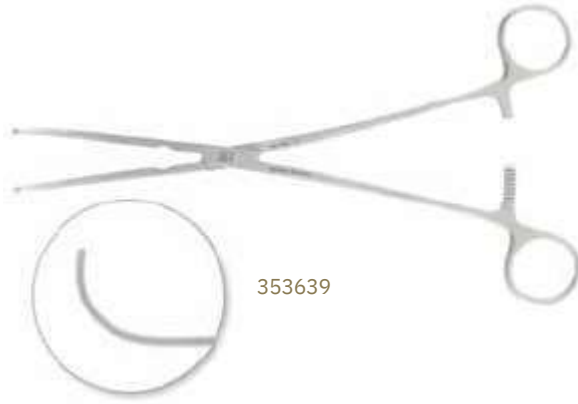

A delicate vascular clamp 25 cm long with curved shanks. Designed as a multi-purpose clamp for vascular surgery. DeBakey®-type Jaws.

Catalog #	Description
353639	9-7/8" (25 cm)

Cooley Vascular Clamps

COOLEY CAROTID, SUBCLAVIAN AND RENAL CLAMP



Long, slender clamp with jaws calibrated on outer sides from distal tip. Curved shafts, angled tips.

Catalog #	Description
354839	Carotid, jaw length 5/8" (15 mm), 7-3/4" (19.5 cm)

VASCULAR CLAMPS

Cooley Vascular Clamps

COOLEY COARCTATION CLAMPS

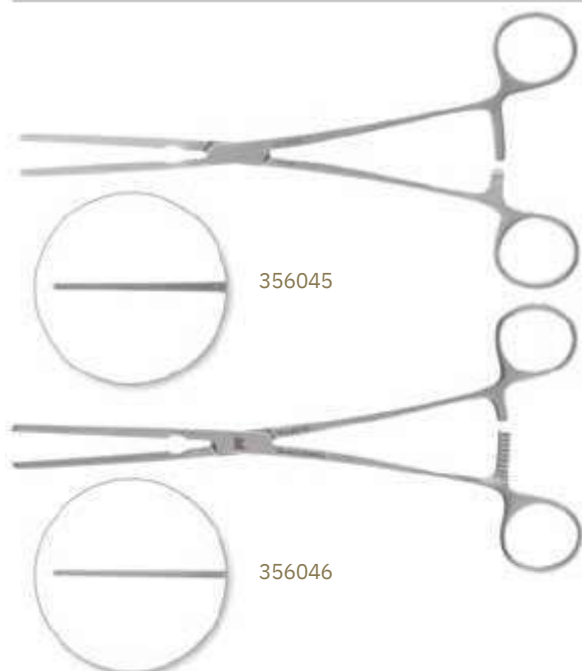

Standard length.

Catalog #	Description
356045	Straight, jaw section 2-7/8" (7.5 cm) long, 8-3/4" (22.5 cm)
356046	Angled, jaw section 2-3/8" (6 cm) long, 8-7/8" (22.5 cm)

COOLEY ILIAC CLAMPS

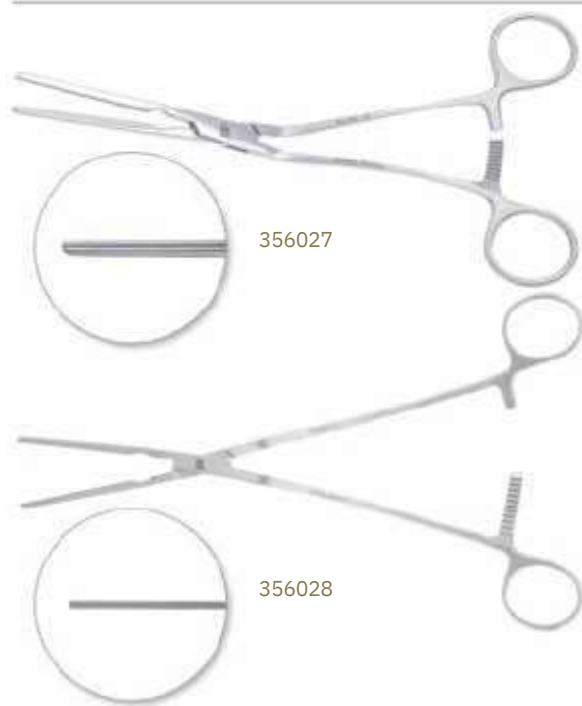

Angled jaws. Unusually long jaws contain Cooley-type serrations only on the distal portion.

Catalog #	Description
356027	Light model, 8-1/4" (21 cm)
356028	9-3/4" (25 cm)

VASCULAR CLAMPS

Cooley Vascular Clamps

COOLEY JAW MULTIPURPOSE CLAMPS



60 degree angled jaws with curved shafts.

Catalog #	Description
356070	No. 1, jaw length 1-1/2" (4 cm), 9-1/8" (23 cm)
356071	No.2, jawlength2-1/8"(5.5cm),8-1/2"(21.5cm)
356072	No.3, jawlength2-1/2"(6.5cm),8-1/2"(21.5cm)

VASCULAR CLAMPS

Cooley Vascular Clamps

COOLEY PARTIAL-OCCLUSION CLAMPS

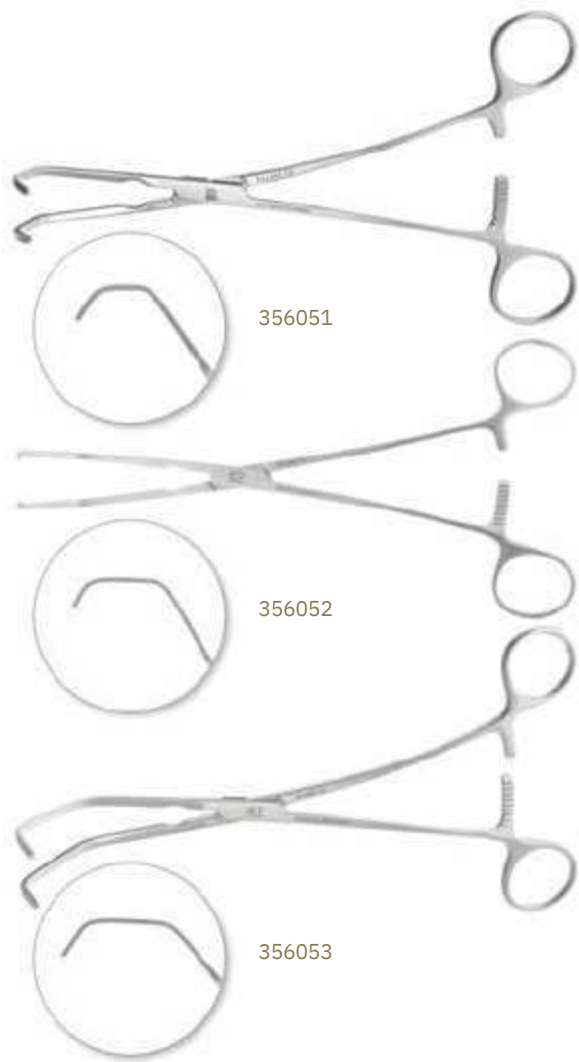

Full adult size with Cooley 2 x 2 jaws, varying in length and jaw size. All have long distal sections adding to their value as partial tangential occlusion clamps.

Catalog #	Description
356051	No. 1, (A) length 1" (2.5 cm), overall 8-1/8" (20.5 cm)
356052	No. 2, (A) length 1-1/2" (4 cm), overall 8-7/8" (22.5 cm)
356053	No. 3, (A) length 1-7/8" (5 cm), overall 8-7/8" (22.5 cm)

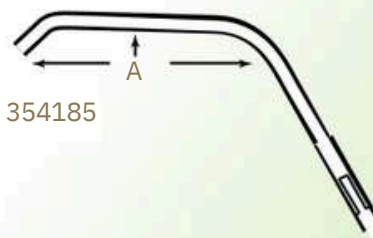

VASCULAR CLAMPS

Cooley Vascular Clamps

COOLEY PATENT-DUCTUS CLAMPS

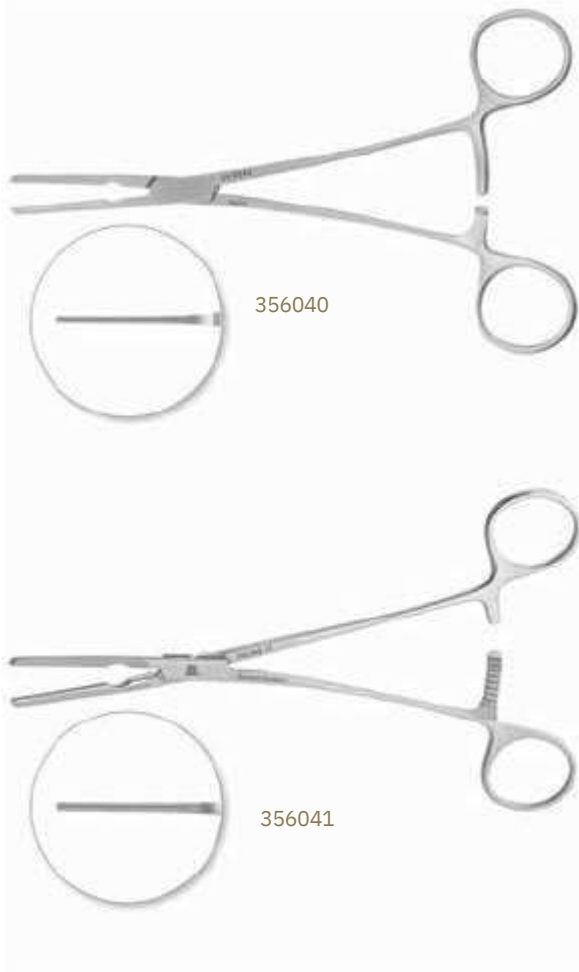

Catalog #	Description
356040	Straight, 8" (20.5 cm)
356041	Angled, 7-7/8" (20 cm)

VASCULAR CLAMPS

Cooley Vascular Clamps

COOLEY PERIPHERAL VASCULAR CLAMPS



Useful for temporarily occluding the femoral, popliteal, subclavian and carotid arteries during performance of thromboendarterectomy or application of by-pass procedures. Relatively lightweight Cooley Jaws.

Catalog #	Description
356025	Angled, 7-1/2" (19 cm)
356031	Curved, 6-3/4" (17 cm)

COOLEY VENA CAVA CLAMPS



Occludes the vena cava and allows bloodflow through the cannula or catheter.

Catalog #	Description
351645	Child size, 24 Fr. Ring tip width, 6-1/8" (15.5 cm)
351646	Child size, 26 Fr. Ring tip width, 7-1/4" (18.5 cm)
351650	Adult size, 28 Fr. Ring tip width, 7-1/4" (18.5 cm)
351651	Adult size, 30 Fr. Ring tip width, 7-1/4" (18.5 cm)
351652	Adult size, 32 Fr. Ring tip width, 7-1/4" (18.5 cm)
351654	Adult size, 34 Fr. Ring tip width, 7-1/4" (18.5 cm)
351653	Adult size, 36 Fr. Ring tip width, 7-1/4" (18.5 cm)

AORTIC VASCULAR CLAMPS

Many Vascular Clamps feature the DeBakey®-type Non-Traumatic Jaws and LIFE-LOK® Mortise Box-Lock.

Ratchets on Vascular Clamps provide the precision control needed for arterial clamping. Ratchets are designed with steps (1 x 7, 1 x 9, 1 x 11) to furnish the specific amounts of desired pressure. Jaws are precision-set by hand.

Coordination of ratchet length and jaw setting provides the accurate amount of required compression.

Many styles of DeBakey®-type Clamps are available with spring handles. With this construction feature, a portion of the shaft is flattened or otherwise altered and specially tempered to eliminate rigidity and provide a softness proportionate with the

overall size and purpose of the instrument. The intention is to minimize trauma to vessels with the soft spring handles but hold securely with DeBakey®-type Jaws.

HISTORY AND ACHIEVEMENTS

Since 1814, has designed and manufactured high quality surgical instruments. As one of the oldest surgical instrument companies in the world, we have continued our tradition of craftsmanship and innovation.

THE BRAND ADVANTAGE

Every cardiovascular instrument that we produce is set and checked by hand, then checked again to assure that it has the essential "feel" that is desired by surgeons. The Brand has gained international acclaim for providing exceptional surgical tools. Working closely with the world's top specialists, we continue to customize instrumentation to meet their exacting individual requirements. We have designed over 500 vascular clamps.

VASCULAR CLAMPS

Aortic Vascular Clamps

BAHNSON AORTA CLAMP



To occlude the aorta during a median sternotomy in the adult. Angle of handle puts it out of the way.

Catalog #	Description
353623	Curved, DeBakey® Jaw, 2-3/4" (7 cm), 9" (23 cm)

BAILEY AORTA CLAMPS



Designed for exclusion of a portion of the vessel, these clamps are medium-weight and have DeBakey®-type Jaws.

Catalog #	Description
354084	Angled shafts, extra-small size jaw, (A) length 1-1/8" (3 cm), 8" (20.5 cm)
354087	Angled shafts, large size jaw, (A) length 2-1/8" (5.5 cm), 9-3/4" (25 cm)

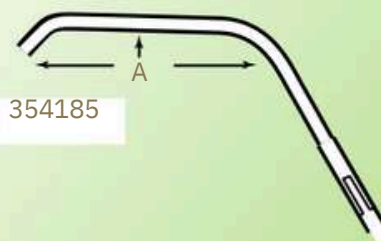

VASCULAR CLAMPS

Aortic Vascular Clamps

BECK-TYPE AORTA CLAMPS



DeBakey®-type Jaws, acutely angled at approximately 65 degrees. Straight shafts.

Catalog #	Description
354100	Angled, DeBakey® Jaw, 1-1/4" (3 cm) tip length (A), 8-1/8" (20.5 cm)
354102	Angled, DeBakey® Jaw, 2" (5 cm) tip length (A), 8-5/8" (22 cm)

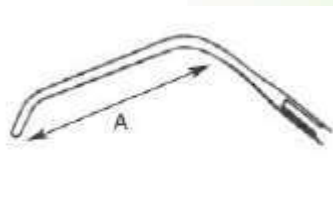

CHERRY SUPRACELIAC CLAMP

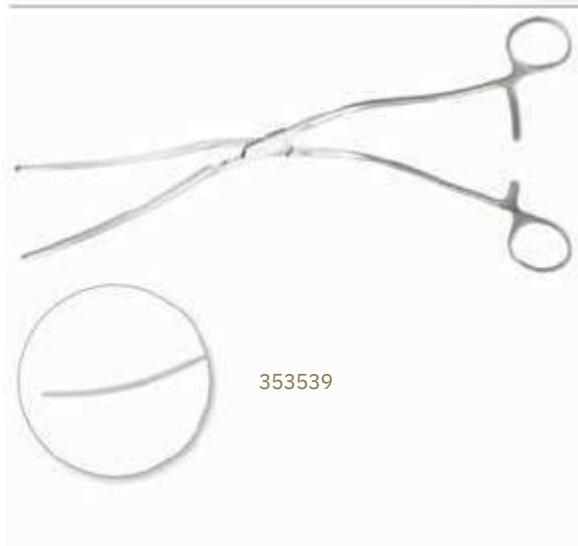

Used in thoracic and abdominal aortic aneurysm repairs, renal vascular procedures, mesenteric artery revascularization. For deep access to aorta superior to the celiac artery. Jaw length and curve combine with angled handle to provide optimum cross clamping capability and reduced operative field obstruction.

Catalog #	Description
353539	Curved, 2 x 3 DeBakey®-type Jaw, 50 degree handle, LIFE-LOK® Box-Lock, 12-1/4" (31 cm)

VASCULAR CLAMPS

Aortic Vascular Clamps

CRAFOORD COARCTATION VASCULAR CLAMPS



Catalog #

354500

354501

Description

Slightly curved, 3-3/8" (8.5 cm) DeBakey®-type Jaw,
1 x 9 ratchets, 9-5/8" (24.5 cm)

Slightly curved, with original, longitudinal jaws,
9-5/8" (24.5 cm)

354500

354501

VASCULAR CLAMPS

Aortic Vascular Clamps

DEBAKEY® MULTI-PURPOSE ANGLED CLAMPS



After considerable use and experimentation with a wide variety of standard pattern clamps, this assortment of matched design DeBakey® Clamps has been assembled. They are of various lengths with curved shafts. The DeBakey®-type Jaws are angulated at 60 or 90 degrees. In addition to their function as aortic clamps, they are available for use as bronchus and gastric clamps in general surgery.

Catalog #	Description
353680	No. 1, 60 degree angle, 1-1/4" (3.5 cm) jaw, 1 x 9 ratchets, 9-1/2" (24 cm)
353682	No. 2, 60 degree angle, 1-3/4" (4.5 cm) jaw, 1 x 9 ratchets, 8-5/8" (22 cm)
353684	No. 3, 60 degree angle, 2" (5 cm) jaw, 1 x 9 ratchets, 9-7/8" (25 cm)
353686	No. 4, 60 degree angle, 3-1/2" (8.9 cm) jaw, 1 x 11 ratchets, 11-5/8" (29.5 cm)
353690	No. 1, 90 degree angle, 1-3/4" (4.5 cm) jaw, 9-1/2" (24 cm)
353692	No. 2, 90 degree angle, 2-1/4" (5.5 cm) jaw, 7-1/4" (18.5 cm)
353694	No. 3, 90 degree angle, 2-3/4" (7 cm) jaw, 9" (23 cm)
353696	No. 4, 90 degree angle, 4-1/8" (10.5 cm) jaw, 10-1/4" (26 cm)



VASCULAR CLAMPS

Aortic Vascular Clamps

DEBAKEY® TANGENTIAL OCCLUSION CLAMPS



Since most of the double angle clamps now available are considered too shallow in the jaw section due to short distal tip section, this deep-jaw selection of DeBakey®-type Clamps was designed. The set consists of five instruments varying in length and jaw size. All have unusually long distal sections, adding to their value as partial tangential occlusion clamps. Dull, non-glare finished stainless steel.

Catalog #	Description
353660	No. 1, 1-3/8" (3.5 cm) jaw, 1 x 9 ratchets, 7-3/4" (19.5 cm)
353662	No. 2, 1-7/8" (5 cm) jaw, 1 x 11 ratchets, 10" (25.5 cm)
353664	No. 3, 2" (5 cm) jaw, 1 x 11 ratchets, 10-3/8" (26.5 cm)
353666	No. 4, 2-3/8" (6 cm) jaw, 1 x 11 ratchets, 10" (25.5 cm)
353668	No. 5, 3-1/8" (8 cm) jaw, 1 x 11 ratchets, 10-1/8" (25.5 cm)
353670	Complete set of 5 clamps

FAVALORO PROXIMAL ANASTOMOSIS CLAMP



Catalog #	Description
353546	Curved, 1-1/4" (3.5 cm) DeBakey®-type Jaws, 8" (20 cm)

VASCULAR CLAMPS

Aortic Vascular Clamps

GERBODE PATENT DUCTUS CLAMP

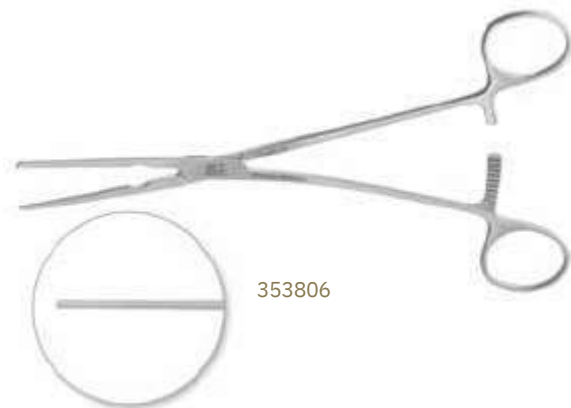

The Glover Patent Ductus Clamps on pg. 638 have been redesigned with extra-narrow 1" (2.5 cm) DeBakey®-type Jaws to provide for maximum length of cut vessel for more convenient suturing.

Catalog #	Description
353806	Angled, 8" (20.5 cm)

GLOVER ATRIAL APPENDAGE CLAMP



Catalog #	Description
354170	Jaw (A) length 1-11/16" (43 mm), (A) depth 1/4" (7 mm), (C) 1-1/8" (30 mm), (D) 1/2" (13 mm), 9-1/2" (24 cm)

DeBakey®-type Jaws. Specially designed for holding the atrial appendage at any level without crushing.

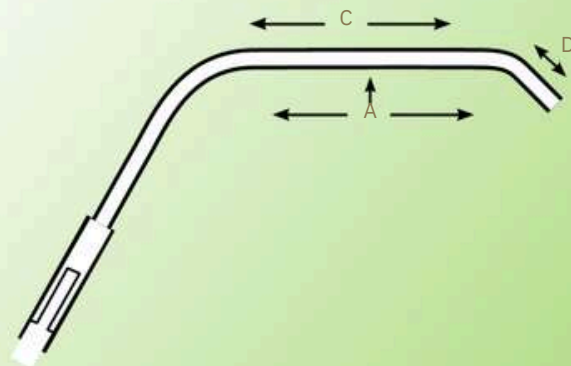

VASCULAR CLAMPS

Aortic Vascular Clamps

GLOVER COARCTATION CLAMPS

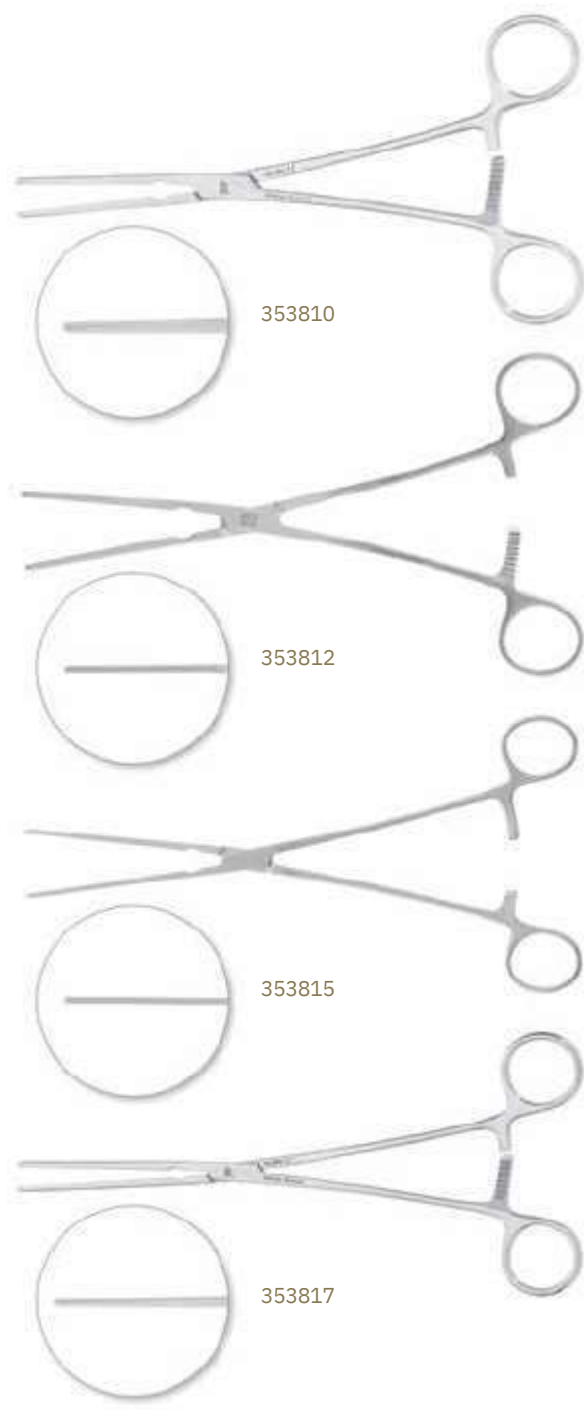

DeBakey®-type Jaw, 1 x 9 ratchets.

Catalog #	Description
353810	Straight, 3-1/8" (8 cm) jaw, 9" (23 cm)
353812	Angled, 3-1/8" (8 cm) jaw, 8-7/8" (22.5 cm)
353815	Extra-long, straight, 3-3/4" (9.5 cm) jaw, 10-5/8" (27 cm)
353817	Extra-long, angled, 3-5/8" (9 cm) tip length, 10-3/8" (26.5 cm)

VASCULAR CLAMPS

Aortic Vascular Clamps

GLOVER CURVED CLAMPS

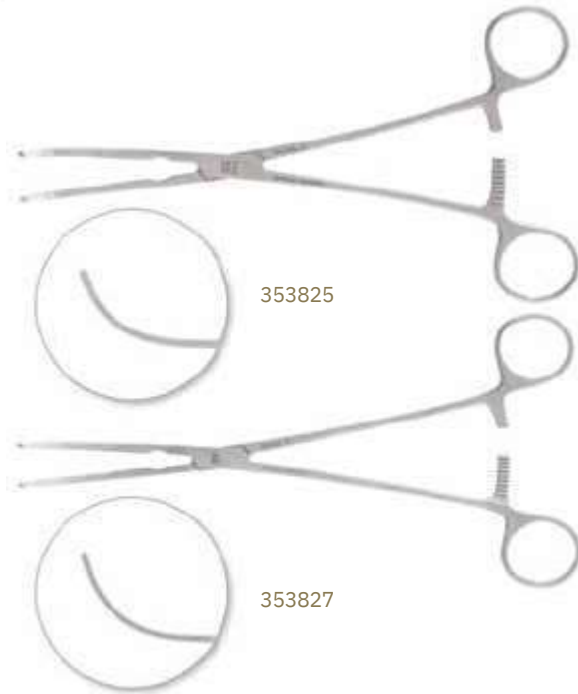

Curved DeBakey®-type Jaws.

Catalog #	Description
353825	Standard size, 1-1/4" (3 cm) jaw, 8-1/2" (21.5 cm)
353827	Extra-long, 1-3/4" (4.5 cm) jaw, 9-7/8" (25 cm)

GLOVER PATENT DUCTUS CLAMPS



DeBakey®-type Jaws, 1 x 9 ratchets.

Catalog #	Description
353800	Straight, 2-1/4" (5.8 cm) jaw, 8-1/8" (20.5 cm)
353802	Angled, 3/4" (1.9 cm) jaw, 8-1/4" (21 cm)

VASCULAR CLAMPS

Aortic Vascular Clamps

GLOVER RIGHT ANGLE CURVED CLAMPS



Curved DeBakey®-type Jaws.

Catalog #	Description
353835	1-7/8" (4.8 cm) jaw, 7-5/8" (19.5 cm)
353837	2-3/8" (6 cm) jaw, 8-7/8" (22.5 cm)

GLOVER SPOON SHAPED CLAMPS



Curved DeBakey®-type Jaws.

Catalog #	Description
353840	Standard size, 2-3/4" (7 cm) jaw, 8-5/8" (22 cm)
353842	Extra-long, 3-7/8" (10 cm) jaw, 10-1/2" (27 cm)

VASCULAR CLAMPS

Aortic Vascular Clamps

HARKEN CLAMPS

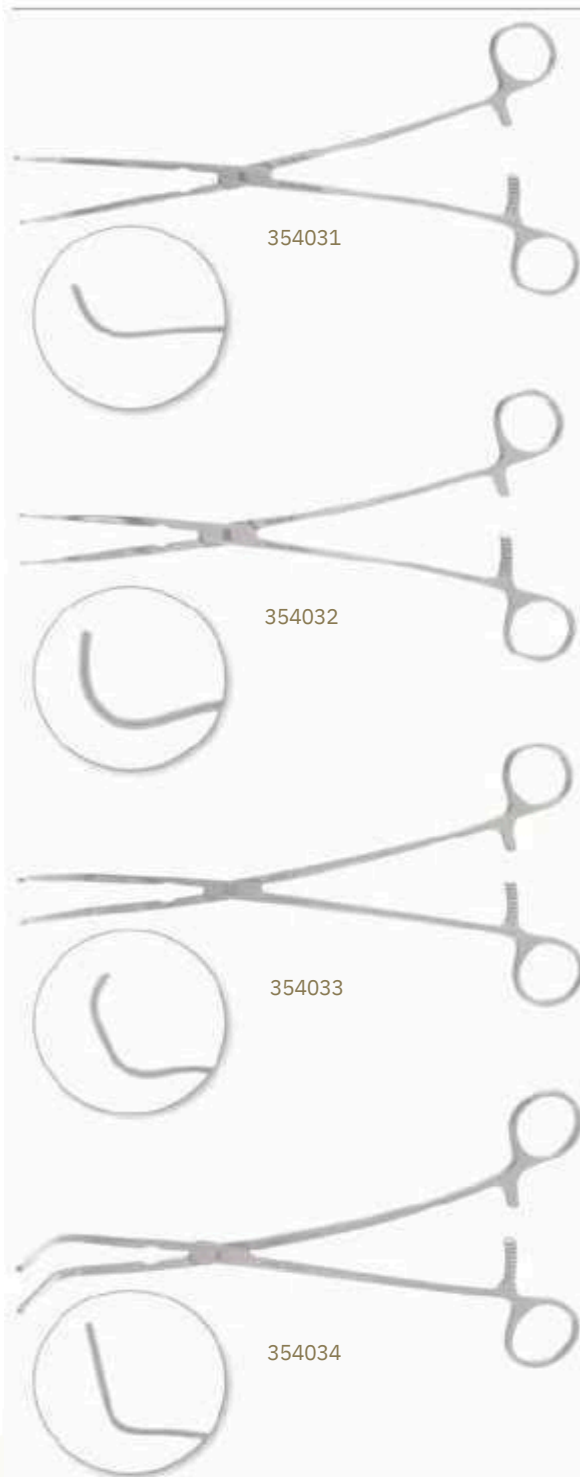

A matched set of four clamps identical in length and weight but with varying DeBakey®-type Jaw shapes.

Catalog #	Description
354031	No. 1 curve, 10-1/2" (26.5 cm)
354032	No. 2 curve, 10-1/8" (25.5 cm)
354033	No. 3 curve, 10" (25.5 cm)
354034	No. 4 curve, 9-5/8" (24.5 cm)

VASCULAR CLAMPS

Aortic Vascular Clamps

HUFNAGEL AORTA CLAMPS



For the ascending aorta. Used to occlude the thoracic aorta in operations on the aortic root and the aortic valve. The curvature of the clamp allows it to be used with the midline sternotomy and to rest out of the operative field. DeBakey®-type Jaws.

Catalog #	Description
353620	Curved, 3-1/8" (8 cm) jaws, 9-5/8" (24.5 cm)
353622	Straight, 3-1/8" (8 cm) jaws, 9-5/8" (24.5 cm)

AORTIC VASCULAR CLAMPS

Kay and Lambert-Kay Anastomosis Clamps

Three clamps designed primarily as side-biting clamps for ascending aorta to be used in lateral anastomosis in saphenous vein coronary artery by-pass procedures. Both clamps may also be applied for partial exclusion of other segments of aorta, large and small bowel. DeBakey®-type Jaws, 1 x 9 ratchets.

KAY-LAMBERT AORTIC ANASTOMOSIS CLAMP



Catalog #
353585

Description
1-3/4" (4.5 cm) jaw, 8-1/8" (20.5 cm)

LAMBERT-KAY AORTIC ANASTOMOSIS CLAMP



Catalog #
353586

Description
Large, 2" (5 cm) tip length, 8-1/8" (20.5 cm)

VASCULAR CLAMPS

Aortic Vascular Clamps

KAY AORTIC ANASTOMOSIS CLAMP



Catalog #	Description
353580	1-1/2" (4 cm) jaw, 7-5/8" (19.5 cm)

LEMOLE-STRONG AORTA CLAMPS



DeBakey®-type Jaw, 1 x 9 ratchets.

Catalog #	Description
353582	Straight shanks, 7-7/8" (20 cm)
353584	Angled shanks, 8" (20.5 cm)



VASCULAR CLAMPS

Aortic Vascular Clamps

STRONG AORTA CLAMPS

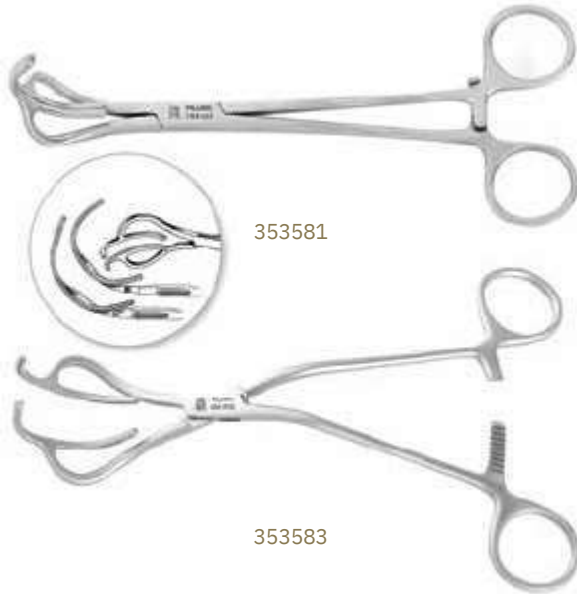

Unique design provides uniform pressure across entire jaw surface. 1 x 9 ratchets.

Catalog #	Description
353581	Straight shanks, 8" (20 cm)
353583	Angled shanks, 8-1/8" (20.5 cm)

MITCHELL AORTOTOMY CLAMP



Catalog #	Description
353588	DeBakey®-type Jaws, 1 x 9 ratchets, 8" (20.5 cm)

VASCULAR CLAMPS

Aortic Vascular Clamps

MORRIS ASCENDING AORTA CLAMPS

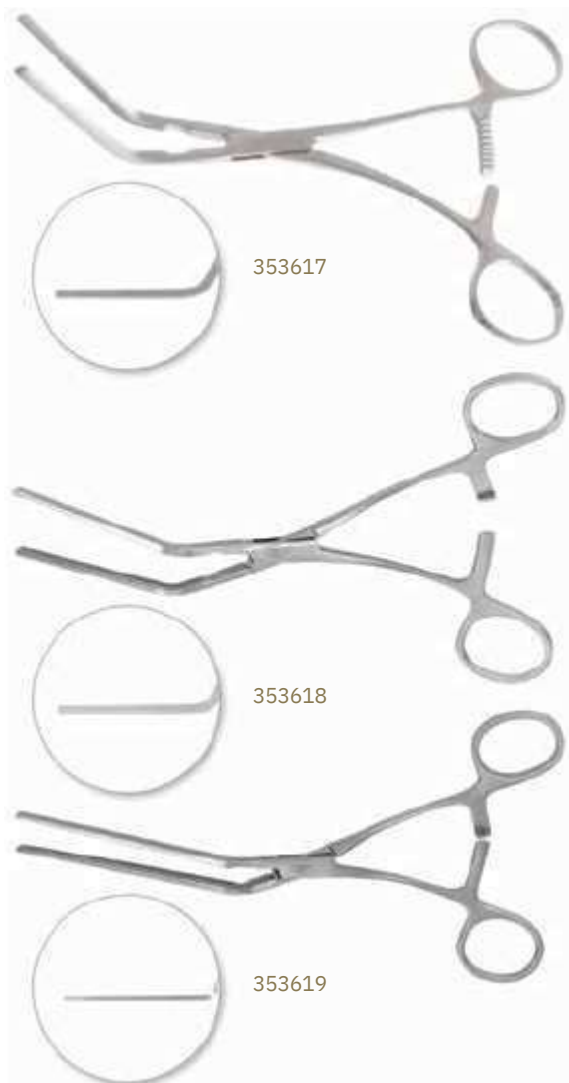

2 x 3 DeBakey®-type Jaws.

Catalog #	Description
353617	Jaws 2-1/2" (6.5 cm) from angle, 8-1/8" (20.5 cm)
353618	Jaws 2-1/2" (6.5 cm) from angle, 9-1/2" (24 cm)
353619	Jaws 3-3/4" (9.5 cm) from angle, 9-1/2" (24 cm)

VASCULAR CLAMPS

Aortic Vascular Clamps

O'NEILL DOUBLE CURVED CLAMP



354165

This is a multipurpose instrument, actually a modification of the DeBakey®-type Satinsky. The jaw angles have been replaced by curves. Useful as a vena cava clamp and atrial appendage clamp, also for cross clamping or partially occluding vessels.

Catalog #
354165

Description
(B) 3-1/8" (80 mm), 10-1/2" (26.5 cm)

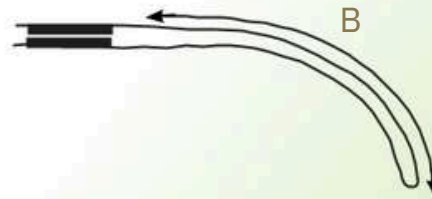

VASCULAR CLAMPS

Aortic Vascular Clamps

SATINSKY CLAMPS

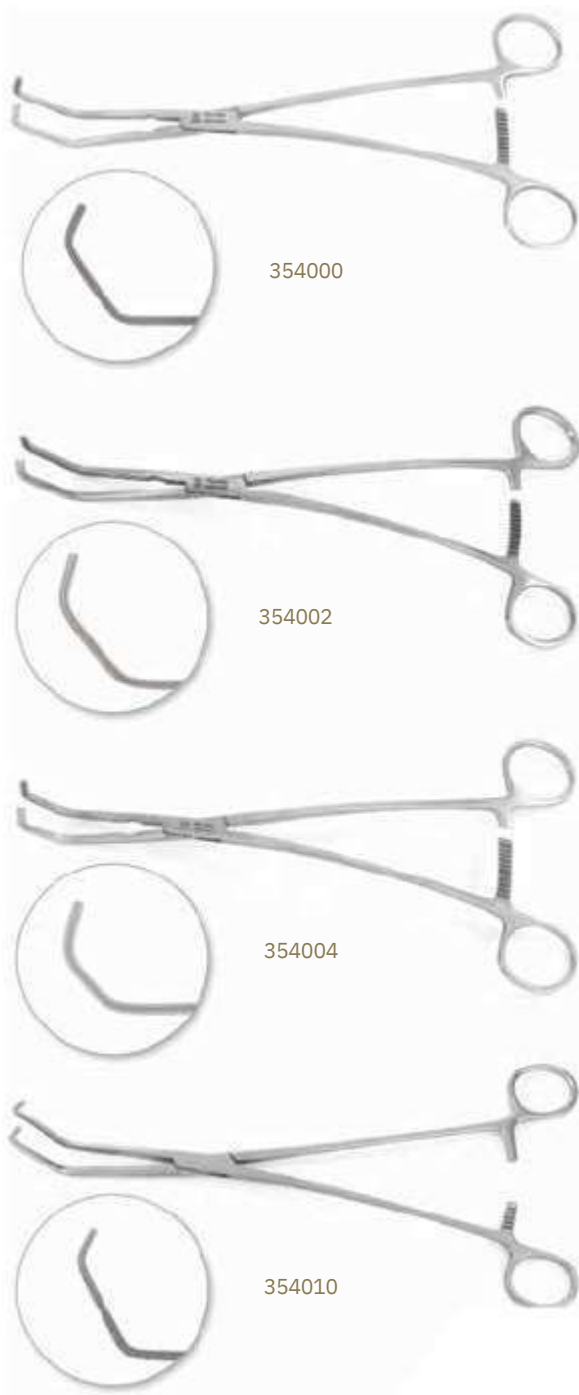

These instruments, originally designed for secure non-crushing grip in clamping the vena cava, have proven to be the most popular and versatile of all cardiac clamps.

They are now provided in a variety of jaw types and sizes as listed. DeBakey®-type Jaws, 1 x 11 ratchets. Dull, non-glare finished stainless steel.

Catalog #	Description
354000	Large, 2" (5 cm) jaw, 10-1/4" (26 cm)
354002	Medium, 1-1/2" (4 cm) jaw, 10" (25.5 cm)
354004	Small, 1-1/4" (3 cm) jaw, 9-3/4" (25 cm)
354005	Set of 3 (354000, 354002, 354004)
354010	Same as Large Satinsky Clamp (354000) except with original criss-cross serrated jaw

VASCULAR CLAMPS

Aortic Vascular Clamps

SCHUMAKER ANGULAR AORTA CLAMPS

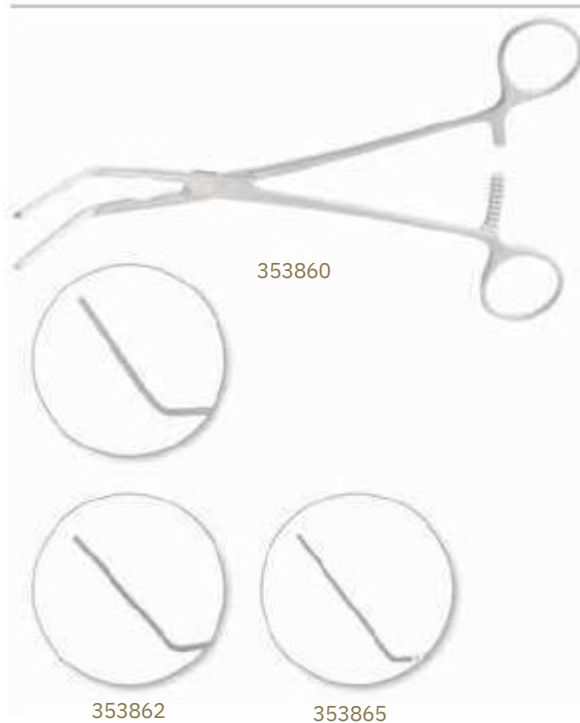

DeBakey®-type Jaws are angled at 60 degrees. These clamps are also used extensively in gastric surgery. Dull, non-glare finished stainless steel.

Catalog #	Description
353860	Standard model, jaws 1-1/8" (5.5 cm) past angle, 8-1/2" (21.5 cm)
353862	Standard model, jaws 2-3/4" (7 cm) past angle, 8-7/8" (22.5 cm)
353865	Heavy model, jaws 3-15/16" (10 cm) past angle, jaw width 4 mm, 11-1/4" (28.5 cm)

STONEY DEEP AORTA CLAMPS

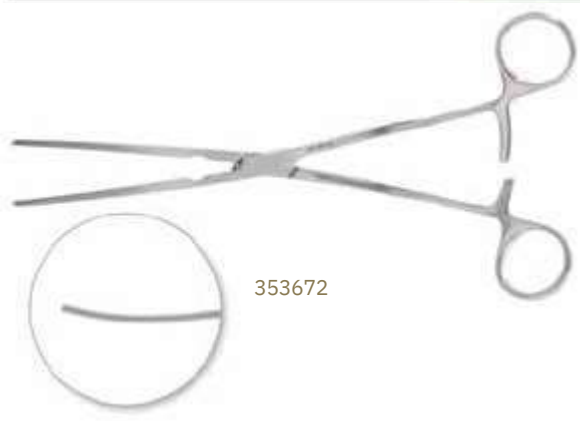

Features severely angled handles to lie across the xiphoid portion of the sternum.

Catalog #	Description
353672	6-7/8" (17.5 cm)
353674	9" (23 cm)



VASCULAR CLAMPS

Aortic Vascular Clamps

WYLIE "J" AORTIC CLAMPS

DeBakey®-type Jaws very acutely curved. Width at (A) 1-1/4" (3.5 cm), depth at (B) 1" (2.5 cm).

Catalog #	Description
353655	Model No. 1, 9-5/8" (24.5 cm)
353656	Model No. 2, 9-1/4" (23.5 cm)

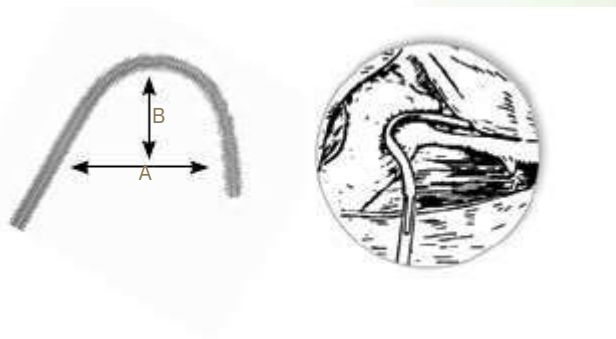

VASCULAR CLAMPS

Aortic Aneurysm Clamps

COOLEY AORTA CLAMP



For temporary occlusion of the abdominal and thoracic aorta during resection and graft replacement. Original Cooley Jaws.

Catalog #	Description
356060	Jaw length 2" (5 cm), 11-1/4" (28.5 cm)

CRAWFORD THORACO-ABDOMINAL ANEURYSM CLAMPS

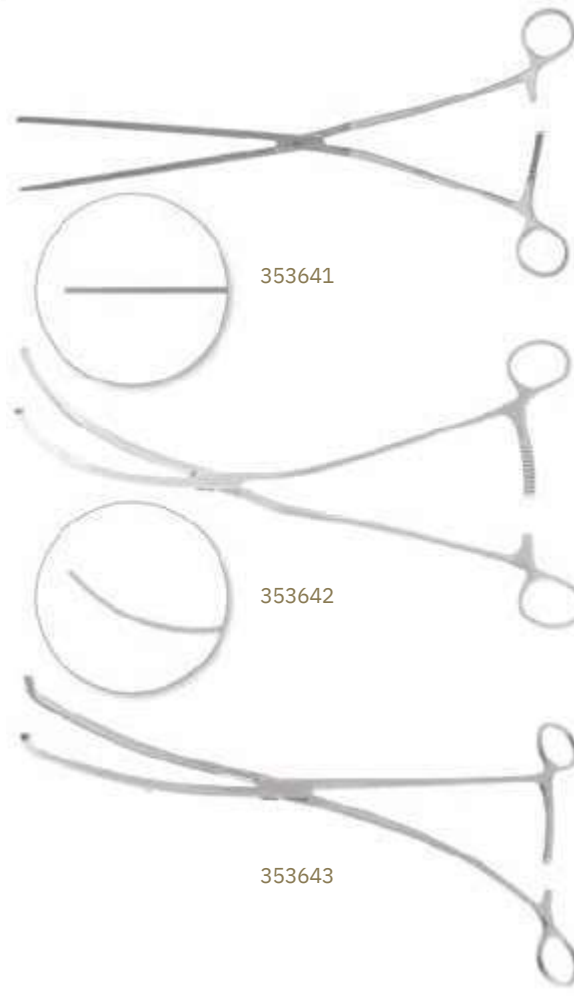

Catalog #	Description
353641	Straight jaw, 6-3/8" (16 cm), 13-1/2" (34 cm)
353642	Curved jaw, angled handle, 12-7/8" (32.5 cm)
353643	"S" curve, angled tip, 13-5/8" (34.5 cm)

VASCULAR CLAMPS

Aortic Aneurysm Clamps

DEBAKEY® AORTA CLAMP



Jaws angled on flat and spoon-shaped. This clamp with DeBakey®-type Jaws may be used for both the abdominal aorta and the thoracic aorta for temporary occlusion during performance of resection and graft replacement. The specially angled jaw permits convenient application of the clamp in such a manner as to maintain the handles of the clamp away from the field of operation.

Catalog #	Description
353650	Angled on flat and spoon-shaped, 2-1/2" (6.5 cm) jaw, 1 x 11 ratchets, 10-1/4" (26 cm)

VASCULAR CLAMPS

Aortic Aneurysm Clamps

DEBAKEY® AORTIC ANEURYSM CLAMPS

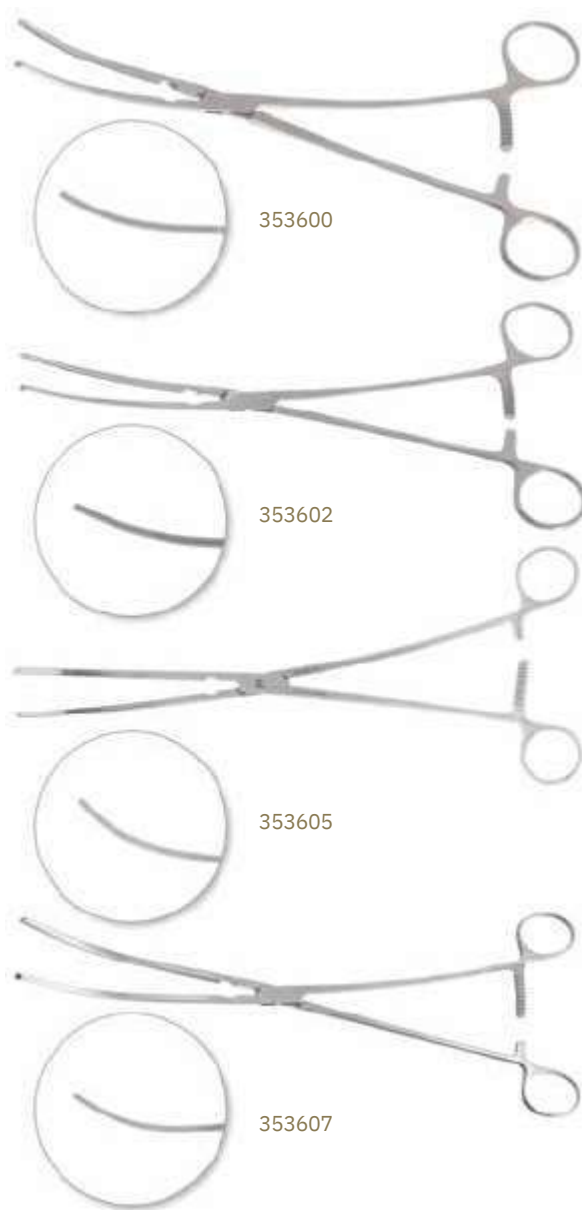

DeBakey®-type Jaws. For occlusion of the neck of sacciform aneurysms of the aorta in tangential excision of such aneurysms and subsequent aortography. Also for temporary occlusion of the aorta in resection of fusiform aneurysms of the aorta and restoration of continuity by aortic grafts.

Catalog#	Description
353600	3-3/4" (9.5 cm) jaw, 1 x 9 ratchets, 10-3/8" (26.5 cm)
353602	4" (10 cm) jaw, 1 x 9 ratchets, 10-7/8" (27.5 cm)
353605	4-7/8" (12.5 cm) jaw, 1 x 11 ratchets, 12-1/2" (32 cm)
353607	5-3/4" (14.5 cm) jaw, 1 x 11 ratchets, 13-1/4" (33.5 cm)

VASCULAR CLAMPS

Aortic Aneurysm Clamps

DEBAKEY® CURVED CLAMPS

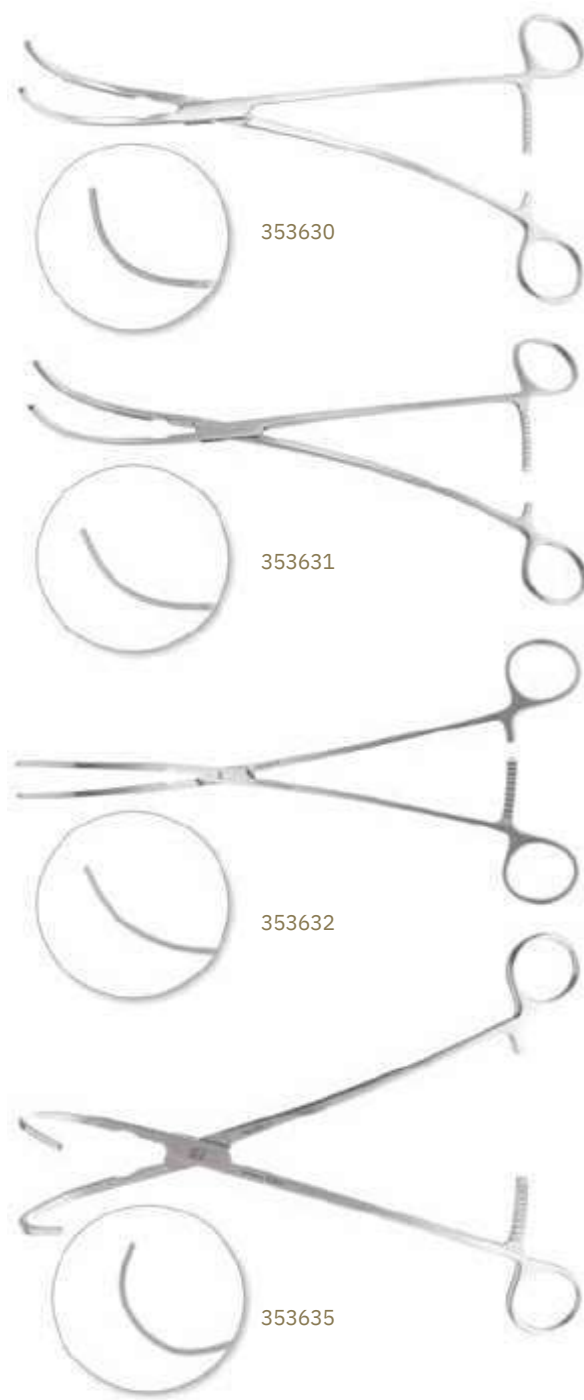

These matched instruments are useful in a wide variety of situations but were originally designed to temporarily occlude the iliac artery just distal to the aorta in resection of aneurysms of the abdominal aorta involving bifurcation. DeBakey®-type Jaws.

Catalog #	Description
353630	Acutely curved, 1-1/4" (3.5 cm) jaw, spring handle, 1 x 11 ratchets, 9-5/8" (24.5 cm) Medium curved,
353631	Bahnsen type, 1-1/4" (3 cm) jaw, spring handle, 1 x 9 ratchets, 10-1/8" (25.5 cm) Slightly curved,
353632	Bahnsen type, 1-1/4" (3 cm) jaw, spring handle, 1 x 9 ratchets, 10-3/8" (26 cm) Extra-large, acutely
353635	curved, 2-1/2" (6.5 cm) jaw, 1 x 11 ratchets, 10-3/8" (26 cm)

VASCULAR CLAMPS

Aortic Aneurysm Clamps

DEBAKEY® FULL CURVED AORTIC ANEURYSM CLAMPS



DeBakey®-type Jaws. More acutely curved in both jaw and handle sections than aortic clamps 353600 to 353607. For occlusion of the neck of sacciform aneurysms of the aorta in tangential excision of such aneurysms and subsequent aortography. Also for temporary occlusion of the aorta in resection of fusiform aneurysms of the aorta in resection and restoration of continuity by aortic grafts.

Catalog #	Description
353625	2-1/8" (5.5 cm) jaw, 9-1/2" (24 cm)
353626	11-1/8" (28.5 cm)
353627	2-1/4" (5.5 cm) jaw, 12-1/2" (31.5 cm)

VASCULAR CLAMPS

Aortic Aneurysm Clamps

GRANT ABDOMINAL AORTIC ANEURYSM CLAMPS, "TEXAS TWISTER"

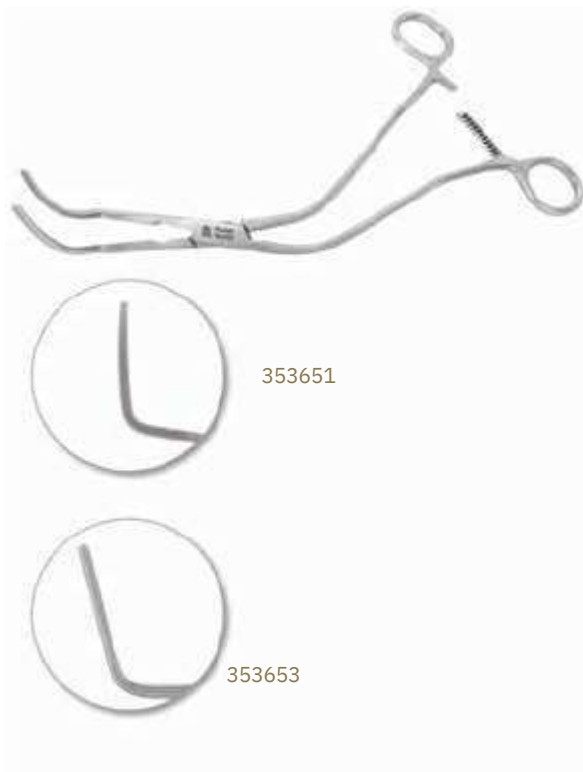

Unique design allows lateral cross clamping of aorta. On thin patients the multi-angled handle can be conveniently placed over left wound margin. In the heavy or obese patient, handles can be tucked under abdominal wall. Wide, secure, 2 x 3 DeBakey®-type Jaws, 1 x 11 ratchets for gradual declamping and graft flushing.

Catalog #	Description
353651	Curved, 2-5/8" (6.5 cm) jaw, 7-7/8" (20 cm)
353653	Short, 2-1/8" (5.5 cm) jaw, 9-1/4" (23.5 cm)

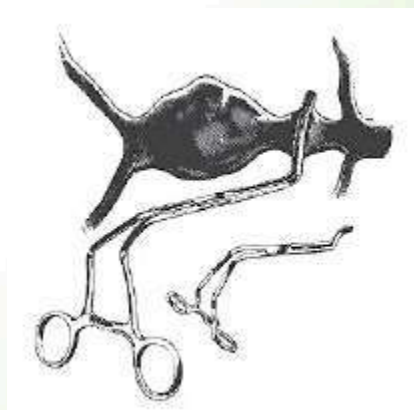

HOWARD-DEBAKEY® AORTIC ANEURYSM CLAMPS



Reverse curve shafts, 1 x 9 ratchets, DeBakey®-type Jaws.

Catalog #	Description
353609	1 x 2, 4-1/8" (10.5 cm) jaws, 10-3/4" (27.5 cm)
353610	2 x 3, 4" (10.5 cm) jaws, 12-1/2" (32 cm)

VASCULAR CLAMPS

Aortic Aneurysm Clamps

WYLIE ABDOMINAL AORTA CLAMP



Catalog #	Description
353658	DeBakey®-type Jaws, 8-1/2" (21.5 cm)

ZANGER ABDOMINAL AORTA CLAMPS

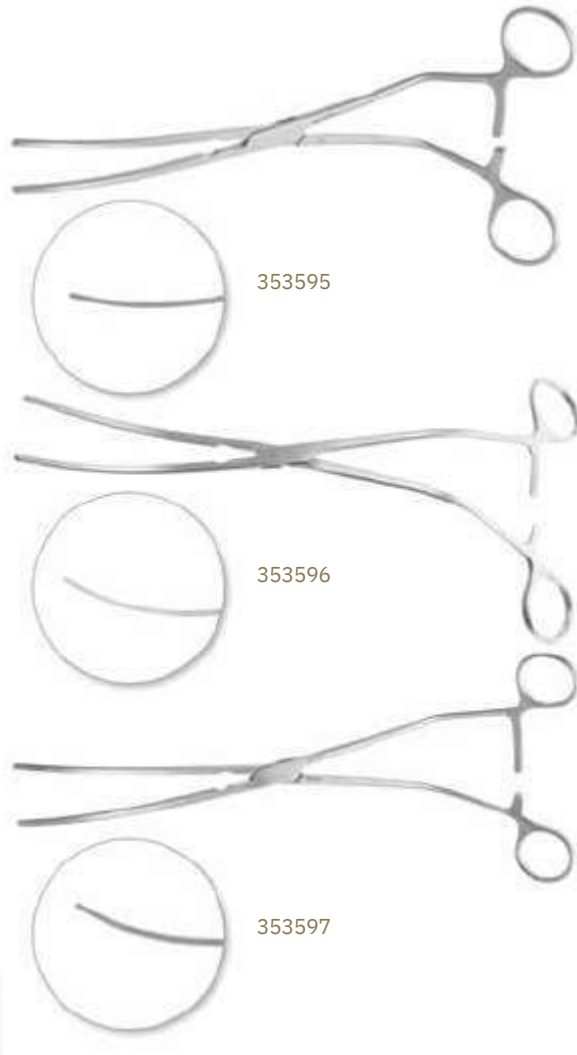

Acutely curved handle, 1 x 9 ratchets.

Catalog #	Description
353595	8-1/8" (20.5 cm)
353596	9-3/4" (25 cm)
353597	11-1/4" (28.5 cm)

VASCULAR CLAMPS

Aortic Aneurysm Clamps

PILLING RATCHET LOCK



354320

Catalog #

354320

Description

Slips on the ratchets of most standard size cardiac clamps. Prevents ratchet from accidentally becoming disengaged and from springing open.

Aortic Compressor

CONN AORTIC COMPRESSOR



351715

A simple device used to gain initial control of the proximal circulation in suspected or known rupture of abdominal aortic aneurysms. Designed to allow surgeon additional time to dissect and cross clamp aorta.

Catalog #

351715

Description

Compressor head 3-1/8" (8 cm) wide, overall length 15-1/2" (39.5 cm)

SCISSORS

SCISSORS

Potts-Style Scissors

BEALL CIRCUMFLEX ARTERY SCISSORS

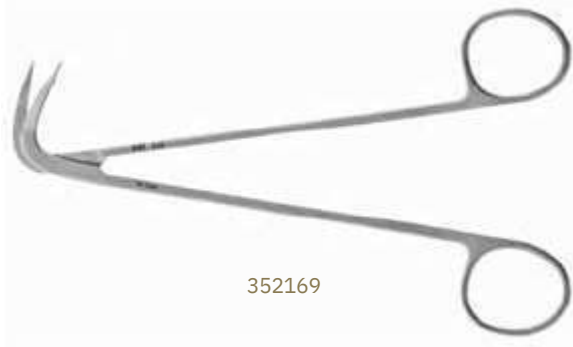

Catalog #
352169

Description
Angled 110 degrees, delicate, 15 mm blades,
6" (15 cm)

SCISSORS

Potts-Style Scissors

DEBAKEY® POTTS SCISSORS



Catalog #
352187

Description
Angled 60 degrees, 25 mm blades, 6-1/4" (16 cm)

SCISSORS

Potts-Style Scissors

BEALL MICRO CORONARY SCISSORS



Delicately tapered shanks, thin narrow blades with micro blunt tips. Available in five angles. The 8-10 mm length blade is approximately 1/2 the length of common coronary artery scissors. This allows the surgeon to prepare smaller, more precise arteriotomy on the host coronary artery as an IMA grafting.

Catalog #	Description
352132	Angled 25 degrees, 8 mm blades, 7" (18 cm)
352133	Angled 45 degrees, 10 mm blades, 7" (18 cm)
352134	Angled 60 degrees, 10 mm blades, 6-7/8" (17.5 cm)
352135	Angled 90 degrees, 8 mm blades, 6-3/4" (17 cm)
352136	Angled 120 degrees, 10 mm blades, 6-3/4" (17 cm)

SCISSORS

Potts-Style Scissors

DEBAKEY® VASCULAR SCISSORS

Angled to the side. A lightweight, round pattern scissors with blunted tip blades. Supplied in 3 angles.



Catalog #	Description
352173	45 degrees, 25 mm blades, 6-1/2" (16.5 cm), TC
352174	60 degrees, 25 mm blades, 6-1/4" (16 cm), TC
352177	60 degrees, 25 mm blades, 8-5/8" (22 cm), TC
352185	25 degrees, 25 mm blades, 6-5/8" (17 cm)
352191	45 degrees, 25 mm blades, 8-7/8" (22.5 cm)
352196	45 degrees, 25 mm blades, 11-1/8" (28 cm)
352197	60 degrees, 32 mm blades, 10-7/8" (27.5 cm)

SCISSORS

Potts-Style Scissors

DEBAKEY®-POTTS SCISSORS



Angled to side. A delicate modification of the Potts Scissors supplied in various angles for use in coronary artery surgery.

Catalog #	Description
352151	Angled 20 degrees, 23 mm blades, 6-5/8" (17 cm)
352153	Angled 45 degrees, 20 mm blades, 6-1/2" (16.5 cm)
352155	Angled 60 degrees, 23 mm blades, 6-1/4" (16 cm)

SCISSORS

Potts-Style Scissors

CORONARY POTTS SCISSORS

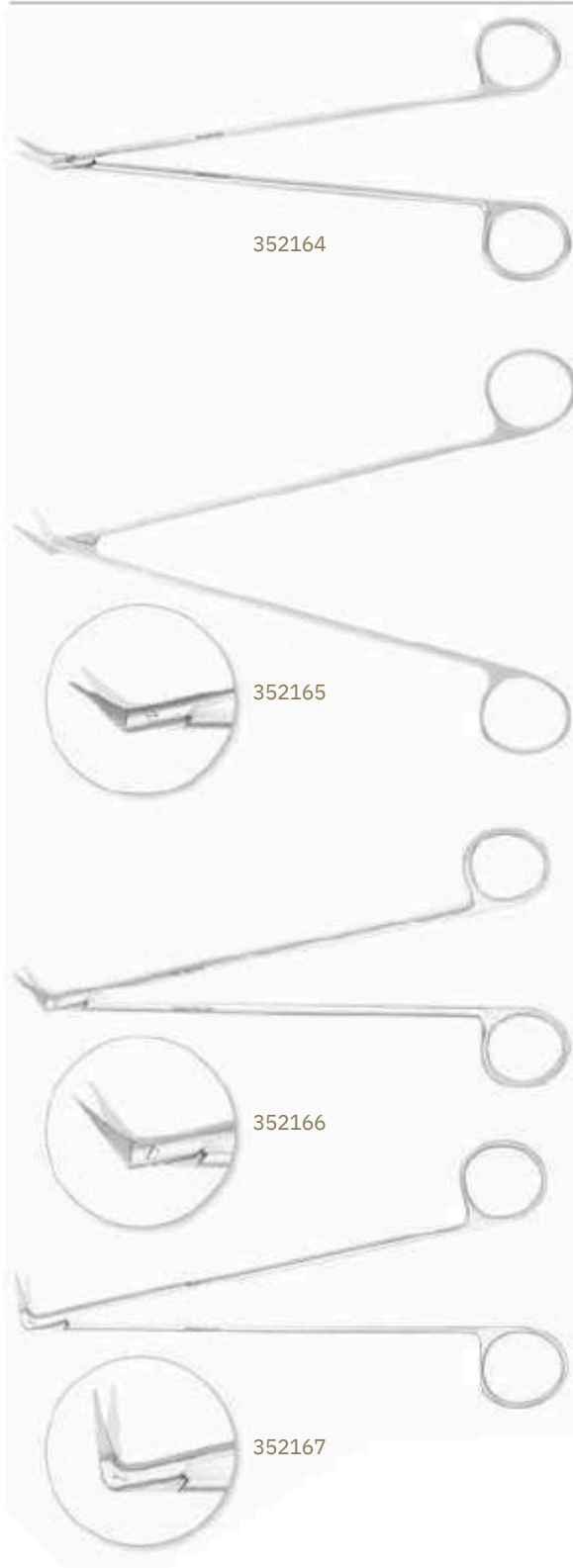

Designed for extending and tailoring coronary arteriotomies. Thin, narrow blades with microscopically blunt tips. Delicately tapered shanks. Available in 5 angles – 25, 45 and 60 degrees for L.A.D., and 90 and 120 degrees for less accessible sites on right and left circumflex.

Catalog #	Description
352164	Angled 25 degrees, 16 mm blades, 7-1/8" (18 cm)
352165	Angled 45 degrees, 16 mm blades, 7" (18 cm)
352166	Angled 60 degrees, 16 mm blades, 7" (18 cm)
352167	Angled 90 degrees, 15 mm blades, 6-3/4" (17 cm)
352168	Angled 120 degrees, 16 mm blades, 6-3/4" (17 cm)
352178	Angled 120 degrees, 13 mm blades, 7" (18 cm)

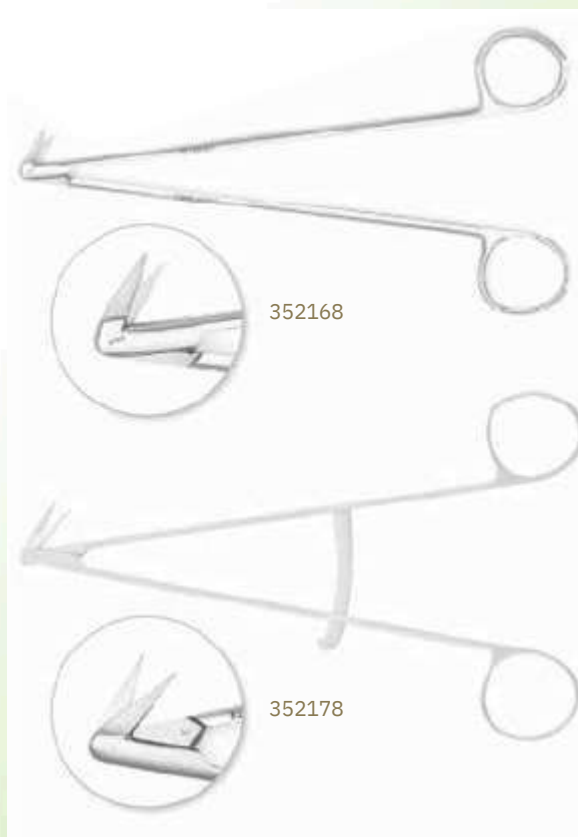

SCISSORS

Potts-Style Scissors

DIETHRICH DELICATE ANGLED CORONARY SCISSORS



Catalog #	Description
352162	Angled 45 degrees, 15 mm blades, 6-1/4" (16 cm)

352162

DIETHRICH-POTTS VASCULAR SCISSORS

Short blades, semi-sharp tips.



Catalog #	Description
352146	Angled 25 degrees, 15 mm blades, 5-1/2" (14 cm)
352147	Angled 45 degrees, 15 mm blades, 5-3/8" (13.5 cm)
352148	Angled 60 degrees, 5-1/4" (13.5 cm)
352149	Angled 90 degrees, 15 mm blades, 5" (12.5 cm)

352146

352147

352148



352149

SCISSORS

Potts-Style Scissors

MICRO VASCULAR SCISSORS



357690

Catalog #
357690
357691Description
Angled 45 degrees, 7 mm blades, 6-1/2" (16.5 cm)
Angled 120 degrees, 7 mm blades, 6-1/2" (16.5 cm)

357691

POTTS SCISSORS



352140

Catalog #
352140Description
Angled 60 degrees, 25 mm blades, 3-3/4" (9.5 cm)

SCISSORS

Potts-Style Scissors

POTTS SMITH SCISSORS



Angled to side. Pattern, satin finish.

Catalog #	Description
352150	Angled 25 degrees, 25 mm blades, 7-1/2" (19 cm)
352170	Angled 25 degrees, 19 mm blades, 7-1/2" (19 cm), TC
352152	Angled 45 degrees, 23 mm blades, 7-1/4" (18.5 cm)
352171	Angled 45 degrees, 19 mm blades, 7-1/4" (18.5 cm), TC
352154	Angled 60 degrees, 23 mm blades, 7" (18 cm)



SCISSORS

Potts-Style Scissors

POTTS SMITH VASCULAR SCISSORS

Standard, angled blades. Weck® Pattern, bright finish.

Catalog #	Description
640210	Angled 25 degrees, 7" (18 cm)
640212	Angled 45 degrees, 7" (18 cm)
640214	Angled 60 degrees, 7" (18 cm)
640216	Angled 130 degrees, 6-3/4" (17 cm)
640225	Angled 25 degrees, 18 mm blades, 7-1/2" (19 cm)
640245	Angled 45 degrees, 18 mm blades, 7-1/4" (18.5 cm)
640260	Angled 60 degrees, 22 mm blades, 7" (18 cm)



SCISSORS

Potts-Style Scissors

YASARGIL VASCULAR SCISSORS



Catalog #	Description
357594	Bayonet, angled 45 degrees, 10 mm blades, 7-1/2" (19 cm)
357595	Bayonet, reverse angled 125 degrees, 12 mm blades, 7-1/4" (18.5 cm)
357622	Straight, 12 mm blades, 7" (18 cm)

YOU-POTTS VASCULAR SCISSORS



Narrow, thin blade and round spring handles designed for a more precise and controlled arteriotomy.

Catalog #	Description
357653	Angled 45 degrees, 12 mm blades, 7-3/8" (18.5 cm)
357642	Angled 90 degrees, 14 mm blades, 7" (18 cm)
357643	Angled 120 degrees, 12 mm blades, 7" (18 cm). Designed for the circumflex artery.

SCISSORS

Vascular and Cardiac Scissors

BAKST CARDIAC SCISSORS



A finely balanced dissecting scissors that can be used interchangeably in all endothoracic dissections. Blades curved to side.

Catalog #	Description
352232	Curved, 7" (18 cm)

DEBAKEY® ENDARTERECTOMY SCISSORS



A specially made, round pattern scissors with blades that taper to blunt tips, tempered for proper rigidity and sharpness despite their light weight. Blades curved to side.

Catalog #	Description
352180	Slightly curved, 7" (18 cm)
352181	Acutely curved, 6-7/8" (17.5 cm)
352183	Slightly curved, 7" (18 cm), TC
352184	Acutely curved, 7" (18 cm), TC

DEBAKEY® SCISSORS



Sturdy Metzenbaum-type scissors. Black rings for quick identification.

Catalog #	Description
342160	Curved, 5-3/4" (14.5 cm), TC
342162	Curved, 7" (18 cm), TC
342166	Curved, 9-1/8" (23 cm), TC
342167	Curved, 10-1/4" (26 cm), TC
342168	Curved, 11-1/4" (28.5 cm), TC
342169	Curved, 12" (30.5 cm), TC

SCISSORS

Vascular and Cardiac Scissors

DEBAKEY® VALVE SCISSORS



Heavy construction.

Catalog #	Description
352199	Acutely curved, 7-3/4" (19.5 cm)

DEBAKEY®-METZENBAUM DISSECTING SCISSORS



Curved blades. These scissors are proportionately matched in weight.

Catalog #	Description
342200	Curved, 5-7/8" (15 cm)
342201	Curved, 7" (18 cm)
342202	Curved, 8-1/8" (20.5 cm)
342203	Curved, 9-1/8" (23 cm)
342204	Curved, 10-1/4" (26 cm)
342206	Curved, 12-1/4" (31 cm)

FERGUSON LONG DISSECTING SCISSORS



Metzenbaum-type blades. Strong but delicate scissors with rounded tips useful in any deep dissection.

Catalog #	Description
342275	10-1/4" (26 cm)

SCISSORS

Vascular and Cardiac Scissors

HAIMOVICI SCISSORS



A delicate, acutely curved scissors.

Catalog #	Description
352297	5-1/4" (13.5 cm)
352298	10" (25.5 cm)

JAMISON-METZENBAUM TENOTOMY SCISSORS



The standard Metzenbaum-style Curved Blades have specially narrowed tenotomy-type distal tips.

Catalog #	Description
342220	6" (15 cm)
342221	7" (18 cm)
342222	8" (20.5 cm)
342223	9" (23 cm)

SCISSORS

Vascular and Cardiac Scissors

OFFSET METZENBAUM SCISSORS

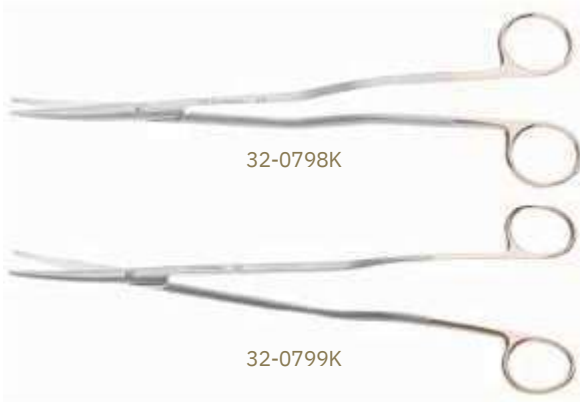

Catalog #	Description
32-0798k	9" (23 cm)
32-0799K	11" (28 cm)

POTTS SMITH DISSECTING SCISSORS



Curved, 48 mm blades.

Catalog #	Description
640200	Curved, 7-1/2" (19 cm)
640205	Curved, 9-1/8" (23 cm)

POTTS TENOTOMY SCISSORS



Catalog #	Description
640280	Curved, 29 mm blades, 6" (15 cm)

SCISSORS

Vascular and Cardiac Scissors

REVUELTA-GARCIA VALVE SCISSORS



Catalog #	Description
351745	Angled shanks, 10-7/8" (27.5 cm)

SATINSKY SCISSORS



For excision of a portion of the inferior vena cava prior to anastomosis with other vessels.

Catalog #	Description
352295	9-3/4" (25 cm)

STRULLY PROBED TIP SCISSORS



Catalog #	Description
462530	Curved, 25 mm blades, 8" (20.5 cm)

SCISSORS

Vascular and Cardiac Scissors

JACOBSON VASCULAR SCISSORS



Catalog #	Description
357623	Curved, 12 mm blades, 7" (18 cm)

MICRO VASCULAR ANASTOMOSIS SCISSORS



Round handle, 8 mm diameter.

Catalog #	Description
357651	Straight, 12 mm blades, 7-3/8" (19 cm)
357652	Curved, 12 mm blades, 7-1/4" (18.5 cm)

NEUROFEEL MICRO SCISSORS



Bayonet with flat handle. Delicate, 5 mm micro blades.

Catalog #	Description
395115	Curved blade, 7-1/4" (18.5 cm)
395128	Straight blade, 8-1/4" (21 cm)

SCISSORS

Vascular and Cardiac Scissors

MCCLURE IRIS SCISSORS



Angled on flat for increased control and visibility.

Catalog #	Description
352144	Angled on flat, 12 mm blades, 4-1/2" (11.5 cm)

352144

CASTROVIEJO SCISSORS



Spring handle for maximum control.

Catalog #	Description
352145	Angled 45 degrees, 9 mm blades, 4-1/8" (10.5 cm)

352145

Venous Valve

VENOUS VALVE SCISSORS

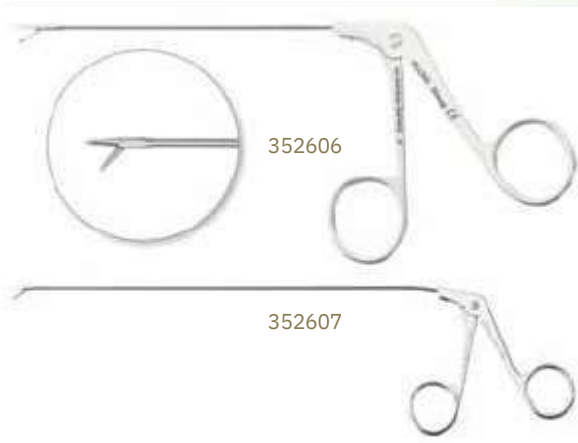

Catalog #	Description
352606	4" (10 cm) scissors have ball tip to help minimize damage to the intima of the vein
352607	9-1/4" (23.5 cm)

352606

352607

CVT NEEDLE HOLDERS

CVTNEEDLEHOLDERS

Technique® Design

Teleflex® takes great pride in presenting our line of finely crafted Technique® Instruments. Technique® Instruments offer the balance, precision and craftsmanship you demand, assuring high quality instrument performance. All are easily identified by our signature black handle design.

BAILEY CARDIAC TECHNIQUE® NEEDLE HOLDER



Very light construction throughout with fine, tapered tips. Jaws are lightly scored for use with smallest size needles and sutures. Tungsten Carbide.

Catalog#	Description
354931	17 x 2 mm jaw, 7" (18 cm), TC

DEBAKEY TECHNIQUE® NEEDLE HOLDERS



Carefully designed with light, short Tungsten Carbide jaws. Constructed in weight proportional to total length. May be purchased individually or as matched set of four.

Catalog#	Description
354900	No. 1. Length, 18.2 x 2 mm jaw, 7" (18 cm), TC
354902	No. 2. Length, 21.5 x 1.8 mm jaw, 9-1/4" (23.5 cm), TC
354904	No. 3. Length, 21.5 x 2.3 mm jaw, 10-1/2" (26.5 cm), TC
354906	No. 4. Length, 19 x 2.6 mm jaw, 11-3/4" (30 cm), TC
354908	Matched set of four

CVT NEEDLE HOLDERS

Technique® Design

GERBODE TECHNIQUE® NEEDLE HOLDER



Medium-light construction. A strong full sized needle holder with jaws tapered to 2 mm width for holding fine needles.

Catalog #
343000

Description

16.5 x 2 mm jaw, 10-1/2" (26.5 cm), TC

HOWELL CORONARY TECHNIQUE® NEEDLE HOLDER



Catalog #
354920

Description

14 x 1.6 mm jaw, 7-1/4" (18.5 cm), TC

HOWELL VALVE TECHNIQUE® NEEDLE HOLDER

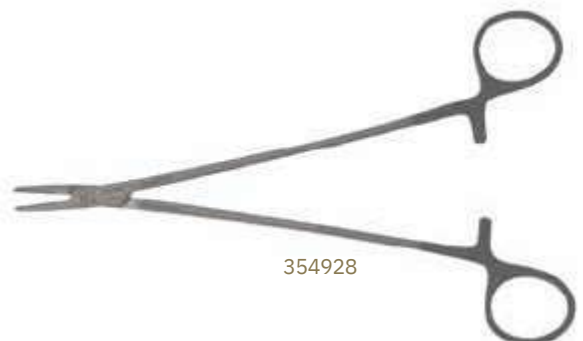

Catalog #
354928

Description

19 x 2 mm jaw, 8" (20.5 cm), TC

CVT NEEDLE HOLDERS

Technique® Design

JAMISON TECHNIQUE® NEEDLE HOLDER



Long, slender needle holder. Jaws are lightly serrated.

Catalog #	Description
354941	19.8 x 1.8 mm jaw, 9" (23 cm), TC

EXTRA LIGHT TECHNIQUE® NEEDLE HOLDERS



Thinner shanks and box-locks than Thin Needle Holders (opposite page) for reduced weight and more "feel."

Catalog #	Description
354981	17 x 1.8 mm jaw, 6" (15 cm), TC
354982	17.5 x 1.6 mm jaw, 7" (18 cm), TC

CVT NEEDLE HOLDERS

Technique® Design

INTRACARDIAC TECHNIQUE® NEEDLE HOLDERS



Catalog #	Description
354985	17 x 1.8 mm jaw, 7" (18 cm), TC
354986	11.5 x 1.6 mm jaw, 8" (20.5 cm), TC
354987	20.5 x 2 mm jaw, 9-1/4" (23.5 cm), TC
354988	20.5 x 2 mm jaw, 10-1/4" (26 cm), TC

354986

THIN VASCULAR AND CORONARY TECHNIQUE® NEEDLE HOLDERS



Delicately proportioned, slender needle holders.

Catalog #	Description
354958	20.5 x 1.8 mm jaw, 9" (23 cm), TC
354959	20.5 x 2.2 mm jaw, 10-1/4" (26 cm), TC
354960	16 x 1.8 mm jaw, 6" (15 cm), TC
354961	16 x 1.7 mm jaw, 7" (18 cm), TC
354962	20 x 1.8 mm jaw, 8-1/4" (21 cm), TC

354962

CVT NEEDLE HOLDERS

Technique® Design

RYDER EXTRA FINE TECHNIQUE® NEEDLE HOLDERS



Pattern, satin finish. Sculptured 1 mm wide jaws designed for the finest vascular, plastic and nerve suture needles. Lightweight throughout (average weight 1 oz).

Catalog #	Description
354990	11.5 x 1.3 mm jaw, 5-1/4" (13.5 cm), TC
354992	12.5 x 1.2 mm jaw, 6" (15 cm), TC
354994	14.3 x 1.2 mm jaw, 7" (18 cm), TC
354996	14.5 x 1.2 mm jaw, 8" (20.5 cm), TC
354998	15 x 1.3 mm jaw, 9" (23 cm), TC

W.M. LEMMON TECHNIQUE® NEEDLE HOLDERS



Delicate, very lightly serrated, 4 mm tapering to 1.5 - 2 mm tips, 13 mm long. The medium size was designed specifically for repair of the femoral arteriotomy site with fine sutures following completion of the by-pass.

Catalog #	Description
354915	Delicate, 15.5 x 2.3 mm jaw, 5-3/4" (14.5 cm), TC
354916	14.5 x 1.5 mm jaw, 6-3/4" (17 cm), TC
354917	15.5 x 2.3 mm jaw, 7-1/2" (19 cm), TC

CVT NEEDLE HOLDERS

Technique® Design

GREGORY TECHNIQUE® SUTURE "STAY" CLAMPS



Smooth jaw hemostats for tagging sutures. May be used with or without rubber shodding.

Catalog #	Description
351830	Straight, 3-7/8" (10 cm), TC
351831	Curved, 3-7/8" (10 cm), TC

GIANNINI TECHNIQUE® NEEDLE HOLDER



Flat handles.

Catalog #	Description
354971	Straight, 17.5 x 1.8 mm jaw, 10-1/4" (26 cm), TC

CVT NEEDLE HOLDERS

Technique® Design

MICRO SURGERY TECHNIQUE® NEEDLE HOLDERS



354967

Flat handle, smooth jaws.

Catalog #	Description
354966	Straight, 13 x 1.4 mm jaw, 7" (18 cm), TC
354967	Straight, 13 x 1.4 mm jaw, 8" (20.5 cm), TC

CASTROVIEJO TECHNIQUE® NEEDLE HOLDERS



354964

Catalog #	Description
354964	Straight, 13 x 1.4 mm jaw, 7-1/4" (18.5 cm), TC
354965	Straight, 13 x 1.4 mm jaw, 8" (20.5 cm), TC

SPENCER CORONARY TECHNIQUE® NEEDLE HOLDER



354969

Catalog #	Description
354969	Straight, smooth, 12 x 1.2 mm jaw, 0.9 mm tip, 7" (18 cm), TC

CVTNEEDLEHOLDERS

Castro-Type Micro Needle Holders

CASTROVIEJO MICRO NEEDLE HOLDERS



355558DG

Fine, straight, with round handle and lock. 1 mm Diama-Grip jaws.

Catalog#	Description
355558DG	9" (23 cm)
355559DG	10"(25.5cm)
355560DG	12"(30.5cm)

CASTROVIEJO MICRO NEEDLE HOLDERS



357676DG

Round handle with Diama-Grip jaws.

Catalog#	Description
357656DG	Straight, with lock, 1.2 mm, 7" (18 cm)
357676DG	Straight, with lock, 1.2 mm, 8" (20.5 cm)
357677DG	Curved, without lock, 1 mm, 8" (20.5 cm)

CASTROVIEJO NEEDLE HOLDERS



354964DG

Straight, with flat handle and lock. Diama-Grip jaws.

Catalog#	Description
354972	Straight, 11.5 x 0.8 mm Diama-grip jaw, 6" (15 cm)
354973	Curved, 11.5 x 1 mm Diama-grip jaw, 6" (15 cm)
354974	Straight, 0.8 mm wide Diama-grip jaw, 7-1/4" (18.5 cm)
354964DG	Straight, 1.8 mm jaw, 7-1/4" (18.5 cm)
354965DG	Straight, 8" (20.5 cm)
354975	Straight, 0.7 mm wide Diama-grip jaw, 8-1/4" (21 cm)

CASTROVIEJO NEEDLE HOLDERS



152818

Catalog#	Description
152818	Straight, 11 x 1.4 mm jaw, 6" (15 cm), T
152819	Curved, 12 x 1.4 mm jaw, 5-3/4" (14.5 cm), TC

CVT NEEDLE HOLDERS

Castro-Type Micro Needle Holders

JACOBSON MICRO NEEDLE HOLDER



357603DG

Catalog #
357603DG

Description
Straight with flat handle, lock, 18 x 1.3 mm Diama-Grip jaw, 8-1/2" (21.5 cm)

JACOBSON MICRO NEEDLE HOLDERS

Straight, round handle with lock. Diama-Grip jaws.



358001

Catalog #
358001
358002
358003

Description
11 x 0.8 mm jaw, 9" (23 cm)
1.8 mm jaw, 9" (23 cm)
16 x 0.9 mm jaw, 8-1/4" (21 cm)



358002



358003

CVTNEEDLEHOLDERS

Castro-Type Micro Needle Holders

JACOBSON MICRO-SURGICAL NEEDLE HOLDERS



357603

Smooth, straight, stainless steel jaws with Castroviejo-type Lock and flat handles. Lock can be removed if not required.

Catalog#	Description
357601	13 x 1.3 mm jaw, 7" (18 cm)
357603	13.5x1.2mmjaw,8-1/2"(21.5cm)

MICROSURGERYNEEDLEHOLDERS



152825

Flat handle, smooth jaws.

Catalog#	Description
152825	Straight, 12.5 x 1.4 mm jaw, 6" (15 cm), TC
152827	Curved, 13 x 1.4 mm jaw, 6" (15 cm), TC

MICRO VASCULAR ROUND HANDLE NEEDLE HOLDERS



357656

357657

Stainless steel jaws, round handles. Smooth jaws.

Catalog#	Description
357667	Straight, 7-3/8" (18.5 cm), TC
357672	Straight, 0.6 mm smooth jaw, 8-1/8" (20.5 cm)
357674	Straight, 0.6 mm smooth jaw, 9" (23 cm)
357675	Curved, 0.6 mm smooth jaw, 9" (23 cm)
357676	Straight, 8" (20.5 cm), TC
357677	Straight, 1 mm jaw, 8" (20.5 cm), TC
357654	Straight, without lock, 1.15 mm jaw, 7-3/8" (18.5 cm)
357655	Curved, without lock, 7-3/8" (18.5 cm)
357656	Straight, with lock, 1.2 mm jaw, 7-1/2" (19 cm)
357657	Curved, with lock, 0.6 mm jaw, 7-3/8" (18.5 cm)

CVT NEEDLE HOLDERS

Castro-Type Micro Needle Holders

DIGITATE-HEIFETZ NEEDLE HOLDERS



066204

Catalog #	Description
066200	Straight, 0.4 mm smooth jaw, 5-3/4" (14.5 cm)
066204	Curved, 0.6 mm smooth jaw, 5-3/4" (14.5 cm)

Wire Twisters

BERRY STERNAL "BIG UGLY" TECHNIQUE® NEEDLE HOLDER



343030

A large, heavy-duty needle holder with 6 mm-wide jaws designed to securely hold the large needles used to close sternotomies. LIFE-LOK®Box-Lock.

Catalog #	Description
343030	28 x 6 mm jaw, 7-3/4" (19.5 cm), TC

BAUMGARTEN WIRE TWISTER



142521

Heavy, square jaw.

Catalog #	Description
142521	18 x 5 mm heavy, square jaws, 8-1/8" (20.5 cm), TC

CVT NEEDLE HOLDERS

Wire Twisters

RUBIO TECHNIQUE® WIRE TWISTER



Catalog #	Description
351349	12 x 4.5 mm jaw, 5" (12.5 cm), TC

WIRE TWISTING FORCEPS



For twisting ends of wire when securing pump tubing to fittings.

Catalog #	Description
351348	5-3/8" (13.5 cm)

MOUTH AND THROAT INSTRUMENTS

MOUTH AND THROAT INSTRUMENTS

Adenotomes/Tonsillectomes

ADENOTOME BLADES



070522

Use with LaForce and Shambaugh Adenotomes.
Slanted catch knob.

Catalog #	Description
070521	No. 1, small, 55 x 12.5 mm
070522	No. 2, medium, 55 x 16 mm
070523	No. 3, large, 55 x 19 mm

LA FORCE ADENOTOMES



070502

9" (23 cm).

Catalog #	Description
070501	No. 1, small, blade 25 x 16 mm
070502	No. 2, medium, blade 26 x 19 mm
070503	No. 3, large, blade 30 x 22 mm

SHAMBAUGH REVERSE CURVE ADENOTOMES



070511

8-5/8" (22 cm).

Catalog #	Description
070511	No. 1, small, blade 25 x 16 mm
070512	No. 2, medium, blade 26 x 19 mm

WECK DANIELS BLADES



070605

Catalog #	Description
070604	No. 1, for 070600 (pg. 522)
070605	No. 2, for 070601

MOUTH AND THROAT INSTRUMENTS

Adenotomes/Tonsilectomes

WECK DANIELS TONSILLECTOME



070600

4-1/2" (11.5 cm) fluted handle, overall 7-1/8" (18 cm).

Catalog #	Description
070600	No. 1, 18 mm blade, 17 mm fenestration

Curettes

BARNHILL ADENOID CURETTES



461352

Catalog #	Description
461350	# 0, 8-1/2" (21.5 cm)
461351	# 1, 8-1/2" (21.5 cm)
461352	# 2, 8-1/2" (21.5 cm)
461353	# 3, 8-1/2" (21.5 cm)
461354	# 4, 8 5/8" (22 cm)

SHAMBAUGH ADENOID CURETTES

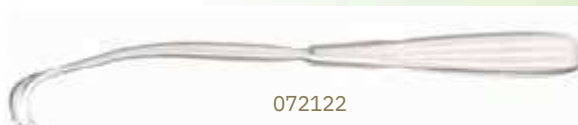

072122

Reverse curve.

Catalog #	Description
072120	Size 0, 11 x 13 mm, 8-1/4" (21 cm)
072122	Size 2, 15 x 18 mm, 8-1/4" (21 cm)
072124	Size 4, 19 X 22 mm, 8-1/4" (21 cm)

MOUTH AND THROAT INSTRUMENTS

Forceps

COLLINS TONGUE SEIZING FORCEPS



Catalog #	Description
452510	Straight, 6-3/4" (17 cm)

COLVER COAKLEY TONSIL FORCEPS



Catalog #	Description
461600	Straight, 7-1/2" (19 cm)
461605	Curved, 7-1/2" (19 cm)

MAGILL CATHETER FORCEPS



Catheter introducing forceps with cross serration.

Catalog #	Description
452550	Adult, 9-1/4" (23.5 cm)
452551	Child, 7-1/8" (18 cm)

MOUTH AND THROAT INSTRUMENTS

Forceps

WHITE TONSIL FORCEPS



461615

Curved.

Catalog #	Description
461610	7-1/8" (18 cm)
461615	9-1/2" (24 cm)

Laryngeal Mirrors

LARYNGEAL MIRRORS



508204

Extra thin, permanently mounted on handle.
Shaft length is 6-3/4" (17 cm). 8" overall length.

Catalog #	Description
508200	#000, 8 mm diameter
508201	#00, 10 mm diameter
508202	#0, 12 mm diameter
508203	#1, 16 mm diameter
508204	#2, 18 mm diameter
508205	#3, 20 mm diameter
508206	#4, 22 mm diameter
508207	#5, 24 mm diameter
508208	#6, 28 mm diameter
508209	#7, 30 mm diameter

Mouth Gags

DAVIS & MCIVOR LEFT TONGUE BLADES



070342

6" (15 cm), for use with right bite Davis Mouth Gags.

Catalog #	Description
070340	Blade Size 2, 2-7/16" x 15/16" (62 x 24 mm)
070342	Blade Size 3, 3" x 1-1/16" (76 x 27 mm)
070344	Blade Size 4, 3-9/16" x 1-5/16" (90 x 34 mm)

MOUTH AND THROAT INSTRUMENTS

Mouth Gags

DAVIS & MCIVOR RIGHT TONGUE BLADES



6" (15 cm), for use with left bite Davis Mouth Gags.

Catalog #	Description
070330	Blade Size 2, 2-7/16" x 15/16" (62 x 24 mm)
070332	Blade Size 3, 3" x 1-1/16" (76 x 27 mm)
070334	Blade Size 4, 3-9/16" x 1-5/16" (90 x 34 mm)

DAVIS MOUTH GAG BLADE, SIZE 2



Without either tubes, fits Davis Mouth Gags only.

Catalog #	Description
070312	Size 2, 70 x 24 mm blade

MOUTH AND THROAT INSTRUMENTS

Mouth Gags

DAVIS MOUTH GAGS



070300



070303

Double bite with silicone liner.

Catalog #	Description
070300	Adult, right bite, 15 x 13 mm block, 80 mm spread, 6-1/8" (15.5 cm)
070301	Adult, left bite, 15 x 13 mm block, 80 mm spread, 6-1/8" (15.5 cm)
070302	Child, right bite, 15 x 9 mm block, 70 mm spread, 5-1/2" (14 cm)
070303	Child, left bite, 15 x 9 mm block, 70 mm spread, 5-1/2" (14 cm)
070305	One dozen replacement silicone liners for both Adult and Child



070305

DINGMAN MOUTH GAG



070450

Catalog #	Description
070450	Set, frame with 3 blades (64 x 25 mm, 70 x 29 mm, 62 x 30 mm), 5-3/4" (14.5 cm)

MOUTH AND THROAT INSTRUMENTS

Mouth Gags

JENNINGS MOUTH GAG



Catalog #
070202

Description
Adult, working length 6" (15 cm), spread 66 mm,
7-3/4" (19.5 cm)

070202

MCIVOR MOUTH GAG



Catalog #
461125
461126
461128

Description
Set, frame with 3 blades (# 2.5, # 3, # 4),
each 5-3/8" (13.5 cm)
Frame only
Blade # 3, 5-3/8" (13.5 cm)

461125



461126

MOUTH AND THROAT INSTRUMENTS

Mouth Gags

SLUDER-JANSEN MOUTH GAG



070232

Catalog #
070232

Description
Curved, 28 x 13 mm blade, 5-1/8" (13 cm)

DENHARDT MOUTH GAG



070222

Catalog #
070222

Description
Serrated, lead bit block 10 x 16 mm,
4-7/8" (12.5 cm)

Retractors

ANDREWS TONGUE DEPRESSOR



070107

Catalog #
070107

Description
Deeply serrated, 21 x 48 mm blade, 30 degree
angle, 4-1/2" (11.5 cm)

MOUTH AND THROAT INSTRUMENTS

Retractors

WIEDER TONGUE DEPRESSORS



Fenestrated, serrated.

Catalog #	Description
070100	Small blade, 41 x 36 mm, 5-9/16" (14 cm)
070101	Large blade, 43 x 43 mm, 6" (15 cm)

070100

HURD DISSECTOR AND PILLAR RETRACTORS



9" (23 cm).

Catalog #	Description
073500	Small dissector 27 x 7 mm, retractor 11 mm
073502	Large dissector 27 x 9 mm, retractor 13 mm

073502

LOTHROP UVULA RETRACTOR



Catalog #	Description
070140	Grooved 36 x 19 mm blade with 5 mm deep lip, 5-3/8" (13.5 cm)

070140

MOUTH AND THROAT INSTRUMENTS

Scissors

BOETTCHER TONSIL SCISSORS



Catalog #
074120

Description
Slightly curved, 42 mm blades, 7-1/4" (18.5 cm)

DEAN TONSIL SCISSORS



Catalog #
074140

Description
32 mm serrated blades, angled on flat, curved shanks, 6-3/4" (17 cm)

YANKAUER TONSIL SCISSORS



Catalog #
074115

Description
Slightly curved, serrated, 42 mm blades,
7-1/8" (18 cm)

MOUTH AND THROAT INSTRUMENTS

Snares

EVE TONSIL SNARES



070651

Catalog #	Description
070651	Standard, 11-1/4" (28.5 cm)
070652	Ratcheted, 11-3/8" (29 cm)



070652

NEIVERT-EVE TONSIL SNARE



070660

Catalog #	Description
070660	10-3/8" (26.5 cm)

LEWIS TONSIL SNARE



070665

Catalog #	Description
070665	10-1/4" (26 cm)

MOUTH AND THROAT INSTRUMENTS

Snares

SAGE TONSIL SNARE



070635

Catalog #	Description
070635	Ratcheted, working length 8-5/8" (22 cm)

TYDING TONSIL SNARE



070640

Catalog #	Description
070640	Straight tip, 10" (25.5 cm)

THROAT SNARE WIRES



070704

4-3/8" (11 cm) precut. 144 per package.

Catalog #	Description
070701	4 Ga., nose
070702	5 Ga., nose
070704	7 Ga., throat
070705	8 Ga., throat
070706	9 Ga., throat

MOUTH AND THROAT INSTRUMENTS

Miscellaneous

FISHER TONSIL KNIFE AND DISSECTOR



073370

Catalog #
073370

Description
17 x 7 mm serrated outer blade, 8-5/8" (22 cm)

HOLINGER KNIFE HANDLE



506705

For use with surgical blades no. 10, 11, 12 and 15.

Catalog #
506705

Description
11" (28 cm)

MELTZER ADENOID PUNCH



461661

With basket.

Catalog #
461660
461661

Description
1, 5 mm, working length 5-1/2" (14 cm)
2, 7 mm, working length 5-1/2" (14 cm)

NAIL INSTRUMENTS

NAIL INSTRUMENTS

Nail Nippers

ORTHOPEDIC INSTRUMENTS

TURNBULL NAIL NIPPERS

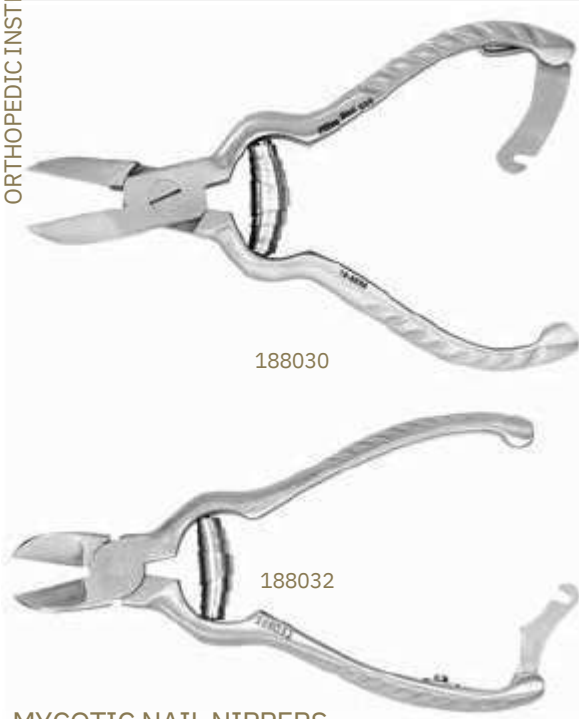

Catalog #	Description
188030	4-1/2" (11.5 cm)
188032	5-5/8" (14.5 cm)

188030

188032

MYCOTIC NAIL NIPPERS



Double action helps prevent hand fatigue. Ideal for Mycotic and Onychiauxis nails. Stainless, double action, barrel spring, 6" (15.5 cm).

Catalog #	Description
GS69445	Straight
GS69446	Concave

GS69445

GS69445

GS69446

SR 69445 CU, Old

SR 69446 CU, Old

NAIL INSTRUMENTS

Nail Nippers

NAIL NIPPERS

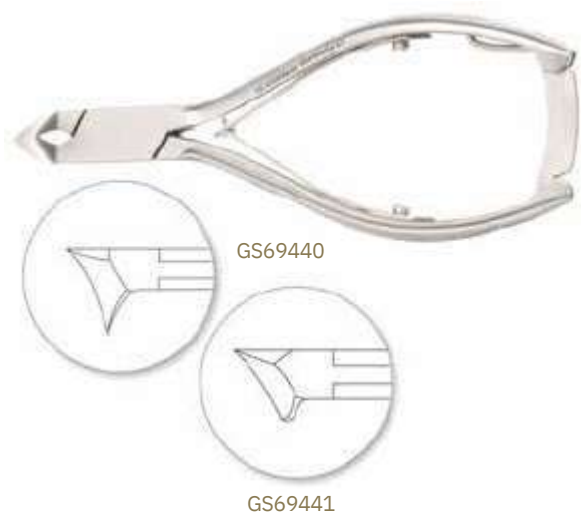

Stainless steel. Angled, concave, 5-1/2" (14 cm).

Catalog #	Description
GS69440	Sharp end
GS69441	Blunt end

GS69440

GS69441

NAIL NIPPERS



Stainless steel, 5-1/2" (14 cm).

Catalog #	Description
GS69418	Narrow, concave
GS69430	Heavy, concave
GS69432	Heavy, straight
GS69438	Heavy, concave, super size

GS69430

81496MK

03496MK

81496MK

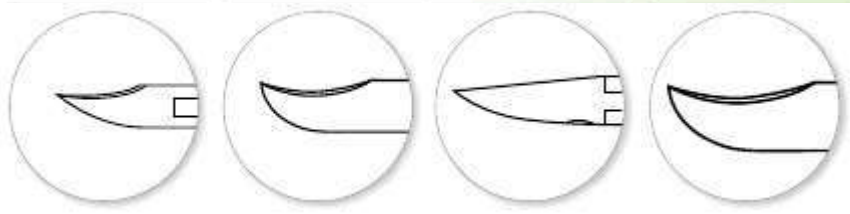

GS69418

03496MK

GS69432

GS69438

NAIL INSTRUMENTS

Nail Nippers

ORTHOPEDIC INSTRUMENTS

NAIL NIPPERS



Stainless steel.

Catalog #	Description
GS69290	6 mm, 4" (10 cm)
GS69291	9 mm, 4" (10 cm)
GS69292	11 mm, 4-1/2" (11.5 cm)
GS69294	14 mm, 5" (12.5 cm)

Nail Splitters

NAIL SPLITTERS



Catalog #	Description
GS69557	Small, straight blade, single-ended, 5" (12.5 cm)

NAIL INSTRUMENTS

Nail Splitters

NAIL SPLITTERS



With grooved handles to improve grip.

Catalog #	Description
GS69320	4" (10 cm)
GS69322	4-1/2" (11.5 cm)
GS69326	Heavy jaw, 5" (12.5 cm)
GS69327	Narrow jaw, 5" (12.5 cm)
GS69340	6" (15 cm)

GS69320



GS69320



GS69322



GS69326



GS69327



GS69340

NAIL SPLITTERS



Our splitters have the true feel of superb craftsmanship. The cutting edge is expertly ground and specially heat treated. For a sure grip, our stainless splitters come with grooved handles. Stainless steel.

Catalog #	Description
GS69341	Tapered, 4" (10 cm)
GS69342	Tapered, 4-1/2" (11.5 cm)
GS69343	Tapered, 5" (12.5 cm)
GS69344	Tapered, 6" (15 cm)
GS69448	Delicate, 4-1/2" (11.5 cm)

GS69341



GS69341



GS69342



GS69343



GS69344



GS69448

NAIL INSTRUMENTS

Nail Splitters

ORTHOPEDIC INSTRUMENTS

SHORT JAW NAIL SPLITTERS



GS69930

Short jaw design provides increased leverage for easier cutting of thick nails — less strain on hand and splitter. Stainless steel.

Catalog #	Description
GS69930	Straight, 5" (12.5 cm)
GS69932	Straight, 6" (15 cm)

Nail Forceps

INGROWN NAIL FORCEPS



GS69348

Very delicate anvil design slides easily under nails.

Catalog #	Description
GS69348	Anvil pattern, narrow blade, 5" (12.5 cm)

NAIL INSTRUMENTS

Nail Forceps

PLATYPUS NAIL REMOVING FORCEPS



Catalog #	Description
GS69792	3 mm, narrow, 5-1/2" (14 cm)
GS69793	6 mm, broad, 5-1/2" (14 cm)

Nail Scissors

INGROWN NAIL INSTRUMENT #81



Catalog #	Description
GS69595	Single-ended, 5" (12.5 cm)

NAIL INSTRUMENTS

Nail Scissors

ORTHOPEDIC INSTRUMENTS

INGROWN NAIL SPLITTING SCISSORS



Catalog #
GS69805

Description
One serrated blade, 6" (15 cm)

NAIL SCISSORS



Catalog #
GS69106

Description
Curved, 4" (10.5 cm)

NASAL INSTRUMENTS

NASALINSTRUMENTS

Elevators

BOIES NASAL ELEVATOR



053115

Catalog#
053115

Description
Straight, 9.5 mm tip, 7-3/4" (19.5 cm)

GOLDMANSEPTUMDISPLACER



441730

Catalog#
441730

Description
6.5 mm wide, 8" (20.5 cm)

COTTLE DOUBLE-ENDED ELEVATOR



053135

Catalog#
053135

Description
Blade A 5 mm, blade B 3 mm, graduated in 10 mm increments, 8-7/8" (22.5 cm)

FREERDOUBLE-ENDEDELEVATORS



036500

Curved, sharp and blunt blades. Weck®Pattern, bright finish. 7-1/2" (19 cm).

Catalog#
036500
036501

Description
Narrow, 4.5 mm
Wide, 6.5 mm

FREERDOUBLE-ENDEDELEVATOR



355194

. Pattern, satin finish.

Catalog#
355194

Description
Blades are sharp and blunt, 4.5 mm wide, 7" (18 cm)

NASAL INSTRUMENTS

Elevators

FREER DOUBLE-ENDED ELEVATOR



GS57614

Catalog #

GS57614

Description
Curved, sharp and blunt blades, 5 mm wide,
7-1/2" (19 cm)

GILLIES ZYGOMA ELEVATOR



441740

Catalog #

441740

Description
1/4" (6 mm) blade, angled, 9" (23 cm)

JOSEPH PERIOSTEAL ELEVATOR



053120

Catalog #

053120

Description
Curved, 4 mm blade, 6-3/4" (17 cm)

MCKENTY ELEVATOR



053102

Catalog #

053102

Description
Curved, 5 mm blade, 5" (12.5 cm)

KLEINERT KUTZ ELEVATOR AND DISSECTOR



GS57615

Catalog #

GS57615

Description
2 mm x 3 mm sharp ends, 7-5/8" (19.5 cm)

ALLERDYCE ELEVATOR AND DISSECTOR

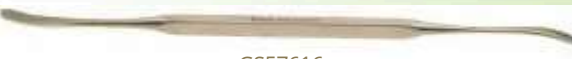

GS57616

Catalog #

GS57616

Description
8 mm semi-sharp and 8 mm blunt ends,
7-1/2" (19 cm)

NASAL INSTRUMENTS

Forceps

ALLIGATOR NASAL FORCEPS



Catalog #
057150

Description
Serrated 10 x 1 mm jaw, shaft 7" (18 cm)

NOYES NASAL ALLIGATOR FORCEPS



Catalog #
431325

Description
Straight, serrated, 8 x 2 mm jaw, shaft 5-1/2" (14 cm)

BLAKESLEY NASAL FORCEPS



Catalog #
031430

Description
Serrated, 13.5 x 7 mm jaw, shaft 7-1/2" (19 cm)

NASAL INSTRUMENTS

Forceps

TAKAHASHI FORCEPS



431360

Catalog #
431360
431362

Description
2.5 mm wide, 4-7/8" (12.5 cm)
4 mm wide, 4-7/8" (12.5 cm)

WILDE (BLAKESLEY) NASAL FORCEPS



431366

Fenestrated cup, pointed tip.

Catalog #
431366

Description
Medium, 10.5 x 4 mm jaw, 4-7/8" (12.5 cm)

RUBIN SEPTAL MORSELIZER



056650

Catalog #
056650

Description
Double-action serrated jaw, 15 x 4 mm,
8-1/4" (21 cm)

NASAL INSTRUMENTS

Forceps

JANSEN-MIDDLETON NASAL RONGEURS



Catalog #
031500
031502
031505

Description
Thru cutting cup 13 x 4 mm, shaft 3-1/2" (9 cm)
Thru cutting cup 14 x 5 mm, shaft 3-7/8" (10 cm)
Spoon shaped biting cup 15 x 5 mm,
shaft 3-5/16" (8.5 cm)

ASCH SEPTUM FORCEPS



Catalog #
443610

Description
Angled, 28 mm tip, 9-1/8" (23 cm)

COTTLE COLUMELLA FORCEPS



Catalog #
443480

Description
12 mm tip width, 4-3/8" (11 cm)

NASAL INSTRUMENTS

Knives

BALLENGER KNIVES



Swivel knife.

036111

Catalog #
036110
036111

Description
Straight 3 mm blade, 8" (20.5 cm)
Straight 4 mm blade, 7-1/2" (19 cm)

COTTLE KNIFE GUIDE AND RETRACTOR



050190

Catalog #
050190

Description
Delicate, knife guide 4 mm, retractor 14.5 mm,
7-3/4" (19.5 cm)

COTTLE NASAL KNIFE



050120

Catalog #
050120

Description
Straight 32 x 5 mm blade, 5-5/8" (14.5 cm)

FREER D MODEL SEPTUM KNIFE



036100

Catalog #
036100

Description
8 mm blade, 6-1/2" (16.5cm)

Osteotomes

ANDERSON-NIEVERT OSTEOTOMES



051191

Curved, 8" (20.5 cm).

Catalog #
051190
051191
051195

Description
Right
Left
Straight

COTTLE OSTEOTOMES



051152

Rounded corners, 7-1/4" (18.5 cm).

Catalog #
051150
051152
051155
051158

Description
4mm
6mm
9mm
12mm

NASAL INSTRUMENTS

Osteotomes

MINI OSTEOTOMES



441208

Curved, 5" (12.5 cm).

Catalog #	Description
441207	4mm
441208	6mm

LAMBOTTE-STYLE OSTEOTOMES



051086

5" (12.5 cm), flat thin blade.

Catalog #	Description
051082	2mm
051084	4mm
051086	6mm
051088	8mm
051090	10mm
051092	12mm
051095	15mm

HEX-HANDLE OSTEOTOMES



051104

6" (15.2 cm), flat thin blade.

Catalog #	Description
051102	2mm
051103	3mm
051104	4mm
051105	5mm
051106	6mm
051107	7mm
051109	9mm
051110	10mm

Raspatories

AUFRICHT RASP



052162

Catalog #	Description
052162	Curved, up-cutting blade, 25 x 9 mm, 8" (20.5 cm)

NASAL INSTRUMENTS

Raspatories

AUFRICHT-GLABELLA RASP



Catalog #
052165

Description
Up and down-cutting, curved blade, 9 x 30 mm,
7-1/2" (19 cm)



052165

CONVERSE RASP



Catalog #
052180

Description
Double-ended, fine and course serrations,
7-1/8" (18 cm)



052180

COTTLE RASP



Catalog #
052130

Description
Straight, down-cutting blade, 36 x 9 mm,
8-1/4" (21 cm)

052130

JOSEPH RASP



Catalog #
441530

Description
Fine serrations, 6 -7/8" (15.5 cm)



441530

NASAL INSTRUMENTS

Raspatories

KLEINERT-KUTZ RASP



441555

Catalog #
441555

Description
4-sided tips, 7.5 mm wide, 8-5/8" (22 cm)

MALTZ RASP

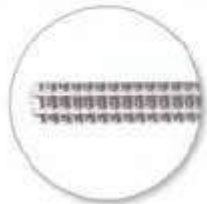

052100

Catalog #
052100

Description
Straight, down-cutting blade, 37 x 6 mm,
7-1/8" (18 cm)

WIENER ANTRUM RASP



037101

Catalog #
037101

Description
Medium, 4 mm trocar point, 7-7/8" (20 cm)

NASAL INSTRUMENTS

Scissors

BECKER SEPTUM SCISSORS



Catalog #
431425

Description
3/4" (2 cm) serrated blades, 7" (18 cm)

CAPLAN NASAL SCISSORS



Catalog #
031750

Description
20 mm serrated blades angled 45 degrees,
7" (18 cm)

FOMAN NASAL SCISSORS



Catalog #
056400

Description
40 mm angled, straight, smooth blades,
5-1/2" (14 cm)

NASAL INSTRUMENTS

Scissors

FOMON LOWER LATERAL SCISSORS



Catalog #
056360

Description
25 mm strongly curved blades, 5-1/4" (13.5 cm)

KNIGHT NASAL SCISSORS



Catalog #
031800

Description
42 mm blades angled 30 degrees, 6-1/4" (16 cm)

RHINOPLASTY FLAT TIP SCISSORS



Catalog #
056302

Description
35 mm curved blades, flat dissecting tips,
5-3/8" (13.5 cm)

NASAL INSTRUMENTS

Sinus Instruments

FESS SINOSCOPY FORCEPS



431433

Catalog #
431433

Description
Serrated, 5-3/4" (14.5 cm)

THRU-CUT FORCEPS



431437

Catalog #
431437

Description
Serrated upper jaw, 5-3/4" (14.5 cm)

BACKBITER FORCEPS



431440

Catalog #
431440

Description
Straight, jaw 1.5 x 6 mm, 7" (18 cm)

NASAL INSTRUMENTS

Sinus Instruments

SIDE BITER FORCEPS



Catalog #	Description
431445	Right-side downward cut, 3 mm tip, 5-1/8" (13 cm)
431446	Left-side downward cut, 3 mm tip, 5-1/8" (13 cm)

KERRISON THRU-CUT RONGEURS



Catalog #	Description
431451	Curved 30 degrees, 7-7/8" (20 cm)
431452	Curved 70 degrees, rotating, working length 5-5/8" (14.5 cm)
431461	Straight, rotating, working length 4-3/4" (12 cm)
431462	Angled 30 degrees, 8" (20.5 cm)
431463	Angled 45 degrees, 7-3/4" (19.5 cm)



FRONTAL SINUS THRU-CUT FORCEPS



Catalog #	Description
431480	3.5 mm tip, 8-5/8" (22 cm), 5-1/8" (13 cm)

NASAL INSTRUMENTS

Sinus Instruments

FRONTAL SINUS FORCEPS



<p>431481</p>	<p>Catalog # 431481</p>	<p>Description 5-1/8" (13 cm)</p>
---------------	-----------------------------	---------------------------------------

SINUS SEEKERS



<p>431710</p>	<p>Catalog # 431710</p>	<p>Description Maxillary Seeker: 1.5 mm and 1.8 mm ball tips, 8-1/8" (20.5 cm)</p>
<p>431711</p>	<p>431711</p>	<p>Frontal Seeker: 1.8 mm ball tip and 0.9 mm tip, 7-7/8" (20 cm)</p>

FRONTAL SINUS CURETTES



<p>431728</p>	<p>Catalog # 431728</p>	<p>Description Angled, 45 degrees, 2.8 mm tip, 7-1/2" (19 cm)</p>
<p>431729</p>	<p>431729</p>	<p>Angled, 45 degrees, 3.5 mm tip, 7-5/8" (19.5 cm)</p>
<p>431732</p>	<p>431732</p>	<p>Angled, 90 degrees, 2.8 mm tip, 7-1/2" (19 cm)</p>
<p>431733</p>	<p>431733</p>	<p>Angled, 90 degrees, 3.5 mm tip, 7-5/8" (19.5 cm)</p>

NASAL INSTRUMENTS

Snares

BRUENING BAYONET NASAL SNARE



037500

Catalog #
037500

Description
9" (23 cm)

KRAUSE NASAL SNARES

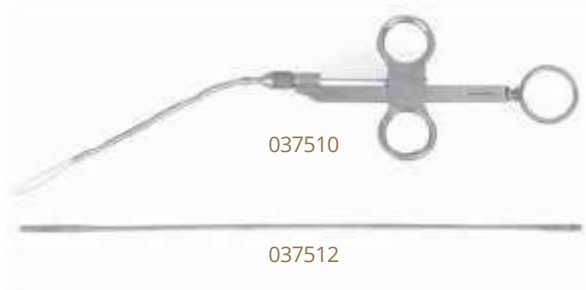

037510

037512

Catalog #
037510
037512

Description
10" (25.5 cm)
Stylet only

NASAL SNARE WIRES



070704

4-3/8" (11 cm) precut. 144 per package.

Catalog #
070701
070702
070704
070705
070706

Description
4 Ga., nose
5 Ga., nose
7 Ga., throat
8 Ga., throat
9 Ga., throat

NASAL INSTRUMENTS

Specula

TIECK INFANT NASAL SPECULUM



030100

Catalog #
030100

Description
18 mm blade, spread 28 mm, 5-1/2" (14 cm)

SONNENSCHNCHILD NASAL SPECULUM



030180

Catalog #
030180

Description
Small, 27 mm blade, spread 28 mm, angled
80 degrees, 6" (15 cm)

KILLIAN NASAL SPECULUMS



030303

Removable spring. 5-1/8" (13 cm).

Catalog #
030301
030302
030303
030304

Description
Size 1, 45 mm blade
Size 2, 55 mm blade
Size 3, 65 mm blade
Size 4, 80 mm blade

NASAL INSTRUMENTS

Specula

COTTLE SEPTUM SPECULUM



431130

Catalog #
431130

Description
5 cm blade, with locking screw, 5-1/2" (14 cm)

VIENNA NASAL SPECULUMS



431111

Catalog #
431110
431111
431112

Description
Small, #1, 28 mm blade, 5-1/4" (13.5 cm)
Medium, #2, 30 mm blade, 5-3/8" (13.5 cm)
Large, #3, 33 mm blade, 5-3/8" (13.5 cm)

PECK-VIENNA NASAL SPECULUM



431120

Catalog #
431120

Description
29 mm blade, 5-3/8" (13.5 cm)

NASAL INSTRUMENTS

Miscellaneous

AUFRICHT NASAL RETRACTOR



054720

Catalog#
054720Description
Small blade, 40 x 8 mm, angled shaft, 6-3/4" (17 cm)

CUTTING BLOCK



411331

Catalog#
411331Description
Made of POM (polyoxymethylene), 3" x 1-1/2" x 3/8" (7.5 x 4 x 1 cm)

OB GYN

OB/GYN

Forceps and Clamps

POLK PLACENTA FORCEPS

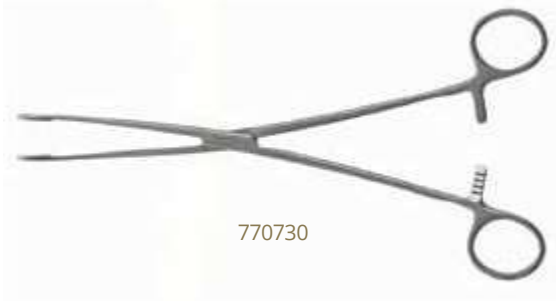

Fenestrated jaw with cross serrations.

Catalog #	Description
770730	Straight, 9-5/8" (24.5 cm)

SOMER UTERINE ELEVATING FORCEPS



Catalog #	Description
213230	9" (23 cm)

WALLACE CAESAREAN FORCEPS



Catalog #	Description
770405	Serrated, 25 mm jaw, 8" (20.5 cm)

OB/GYN

Forceps and Clamps

PHANEUF UTERINE ARTERY FORCEPS

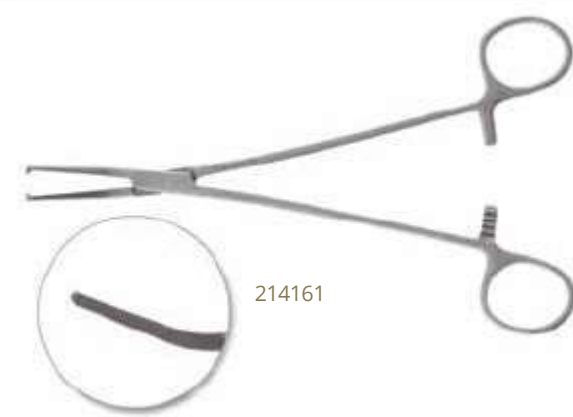

214161

Pattern, satin finish.

Catalog #
214161

Description
Short, heavy jaws, 1 x 2 distal teeth, angled, 8-1/4" (21 cm)

PHANEUF UTERINE ARTERY FORCEPS

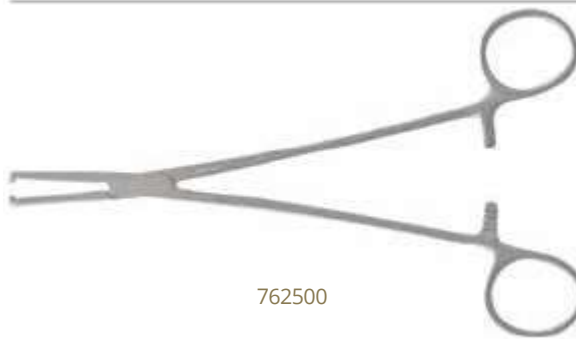

762500

Weck® Pattern, bright finish.

Catalog #
762500

Description
Straight, serrated, 1 x 2 teeth, 4 mm tip,
8-1/4" (21 cm)

BLAND CERVICAL TRACTION FORCEPS



213140

Catalog #
213140

Description
Straight, 10 mm tip, 9-1/4" (23.5 cm)

OB/GYN

Forceps and Clamps

DEBAKEY® HYSTERECTOMY CLAMP



Catalog #	Description
214215	Curved, 9-3/8" (24 cm)

HEANEY HYSTERECTOMY FORCEPS



Double serrated jaws with cross-groove.

Catalog #	Description
214170	Curved, light jaws, single groove, 8-1/4" (21 cm)
214172	Curved, heavy jaws, single groove, 8-1/4" (21 cm)
214175	Curved, heavy jaws, double groove, 8-1/4" (21 cm)



OB/GYN

Forceps and Clamps

HEANEY-BALLANTINE HYSTERECTOMY CLAMPS



Longitudinally serrated jaws. Single groove.

Catalog #	Description
214180	Straight, 8-1/4" (21 cm)
214182	Curved, 8-1/8" (20.5 cm)

WERTHEIM-CULLEN PEDICLE CLAMP



Catalog #	Description
214230	Angled, longitudinally serrated jaws, 8-5/8" (22 cm)

Biopsy Punches

EPPENDORFER BIOPSY PUNCH



Catalog #	Description
GS65162	Straight, 4 x 8 mm bite, 9" (23 cm)

OB/GYN

Biopsy Punches

KEVORKIAN-YOUNGE CERVICAL BIOPSY FORCEPS

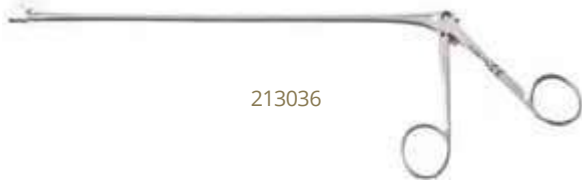

Catalog #
213036

Description
10-1/8" (25.5 cm)

SCHUBERT BIOPSY PUNCHES



Catalog #
766520
766522

Description
Angled to side, 5 x 8 mm punch, 9-5/8" (24.5 cm)
Straight, 5 x 8 mm punch, 11" (28 cm)

SCHUBERT BIOPSY PUNCHES



Catalog #
GS65115
GS65118

Description
Straight, 8-1/2" (21.5 cm)
Angled, 10-1/2" (26.5 cm)

OB/GYN

Biopsy Punches

THOMAS-GAYLOR CERVICAL BIOPSY FORCEPS



213011

Catalog #	Description
213011	Curved shanks, 9-1/4" (23.5 cm)

THOMAS-GAYLOR BIOPSY PUNCH



GS65084

Catalog #	Description
GS65084	Interfitted jaw, 9-1/2" (24 cm)

TISCHLER BIOPSY PUNCHES



GS65186

Catalog #	Description
GS65188	Straight, 3 x 5 mm, 8" (20.5 cm)
GS65186	Straight, 3 x 7 mm, 9" (23 cm)
GS65204	Shaft only, 3 x 7 mm bite
GS65205	Pistol grip handle only for Tischler punch

OB/GYN

Biopsy Punches

WITTNER BIOPSY FORCEPS



752526

8 x 6 mm toothed basket jaw, 8-7/8" (22.5 cm) stem.

Catalog #	Description
752526	Straight, 11-1/2" (29 cm)

Circumcision Clamps

GOMCO® CIRCUMCISION CLAMPS



742110

Catalog #	Description
742100	Extra small, 11 mm
742102	Newborn, 13 mm
742104	Infant, 15 mm
742106	Child, 16 mm
742108	Youth, 21 mm
742110	Adult, 26 mm

OB/GYN

Delivery Forceps

DE LEE OBSTETRICAL FORCEPS



Catalog #
214595

Description
12" (30.5 cm)

MCLEAN-TUCKER-LUIKART OBSTETRICAL FORCEPS



Catalog #
214605

Description
15-1/2" (39.5 cm)

SIMPSON OBSTETRICAL FORCEPS



Catalog #
214550
214555

Description
14" (35.5 cm)
12" (30.5 cm)

SIMPSON-LUIKART OBSTETRICAL FORCEPS



Catalog #
214570

Description
Fenestrated, smooth, 14" (35.5 cm)

OB/GYN

Scissors

BUSCH UMBILICAL SCISSORS



GS67294

Catalog #
GS67294

Description
Curved sideways, 6-1/2" (16.5 cm)

UMBILICAL SCISSORS



214090

Catalog #
214090
GS67292

Description
4-1/8" (10.5 cm)
Straight, 4-3/8" (11 cm)

BRAUN EPISIOTOMY SCISSORS



214081

Catalog #
214081

Description
Wide lower blade, angled to side, 8-3/4" (22 cm)

OB/GYN

Probes, Sounds and Dilators

EMMETT UTERINE PROBE



212600

Catalog#
212600

Description
Sterling Silver, 11" (28 cm)

SIMPSON UTERINE SOUND



212605

Catalog#
212605

Description
4 mm, graduated in inches, silver plated, malleable,
12-3/4" (32.5 cm)

SIMS UTERINE SOUNDS



212612

Catalog#
212610
212612

Description
4 mm, non-graduated, silver plated, malleable,
12-3/4" (32.5cm)
4 mm, graduated in cm, malleable, 12-3/4" (32.5 cm)

OB/GYN

Probes, Sounds and Dilators

HANK UTERINE DILATORS



212666

. Pattern, satin finish. Double-ended. Length 10-3/4" (27.5 cm). All sizes available individually.

Catalog #	Description
212659	Hank Uterine Dilators, set of 6, sizes 11-12 Fr. to 21-22 Fr. (3.66 to 7.33 mm)
212661	9-10 Fr. (3 x 3.3 mm)
212662	11-12 Fr. (3.6 x 4 mm)
212663	13-14 Fr. (4.3 x 4.7 mm)
212664	15-16 Fr. (5 x 5.3 mm)
212665	17-18 Fr. (5.7 x 6 mm)
212666	19-20 Fr. (6.3 x 6.7 mm)
212667	21-22 Fr. (7 x 7.3 mm)
212668	23-24 Fr. (7.7 x 8 mm)
212669	25-26 Fr. (8.3 x 8.7 mm)
212670	27-28 Fr. (9 x 9.3 mm)
212671	29-30 Fr. (9.3 x 10 mm)

HANK UTERINE DILATORS

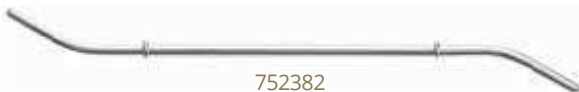

752382

Weck® Pattern, bright finish. Double-ended. End lengths 2-1/2" (6.5 cm). Length 10-3/8" (26.5 cm).

Catalog #	Description
752380	9/10 American (4.5 x 5 mm)
752381	11/12 American (5.5 x 6 mm)
752382	13/14 American (6.5 x 7 mm)
752383	15/16 American (7.5 x 8 mm)
752384	17/18 American (8.5 x 9 mm)
752385	19/20 American (9.5 x 10 mm)

OB/GYN

Probes, Sounds and Dilators

HEGAR UTERINE DILATORS



212673



212678

. Pattern, satin finish. Double-ended, 7-7/8" (20 cm).

Catalog #	Description
212673	Set of 8, sizes 3 mm to 18 mm
212675	Size 3-4 mm
212676	Size 5-6 mm
212677	Size 7-8 mm
212678	Size 9-10 mm
212679	Size 11-12 mm
212680	Size 13-14 mm
212681	Size 15-16 mm
212682	Size 17-18 mm

HEGAR UTERINE DILATORS



752354

Weck® Pattern, bright finish. Double-ended, hollow, 7-7/8" (20 cm).

Catalog #	Description
752338	Size 1/2 mm
752347	Size 19/20 mm
752348	Size 21/22 mm
752349	Size 23/24 mm
752351	Size 25/26 mm
752354	Complete set in case

OB/GYN

Forceps and Clamps

DEBAKEY® HYSTERECTOMY CLAMP



Catalog #	Description
214215	Curved, 9-3/8" (24 cm)

HEANEY HYSTERECTOMY FORCEPS



Double serrated jaws with cross-groove.

Catalog #	Description
214170	Curved, light jaws, single groove, 8-1/4" (21 cm)
214172	Curved, heavy jaws, single groove, 8-1/4" (21 cm)
214175	Curved, heavy jaws, double groove, 8-1/4" (21 cm)

OB/GYN

Forceps and Clamps

HEANEY-BALLANTINE HYSTERECTOMY CLAMPS



Longitudinally serrated jaws. Single groove.

Catalog #	Description
214180	Straight, 8-1/4" (21 cm)
214182	Curved, 8-1/8" (20.5 cm)

WERTHEIM-CULLEN PEDICLE CLAMP



Catalog #	Description
214230	Angled, longitudinally serrated jaws, 8-5/8" (22 cm)

Biopsy Punches

EPPENDORFER BIOPSY PUNCH



Catalog #	Description
GS65162	Straight, 4 x 8 mm bite, 9" (23 cm)

OB/GYN

Biopsy Punches

KEVORKIAN-YOUNGE CERVICAL BIOPSY FORCEPS

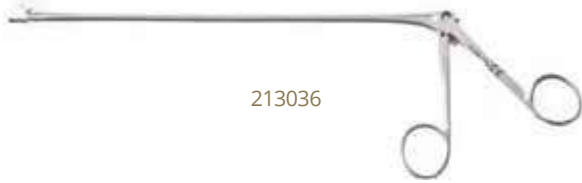

Catalog #
213036

Description
10-1/8" (25.5 cm)

SCHUBERT BIOPSY PUNCHES



Catalog #
766520
766522

Description
Angled to side, 5 x 8 mm punch, 9-5/8" (24.5 cm)
Straight, 5 x 8 mm punch, 11" (28 cm)

SCHUBERT BIOPSY PUNCHES



Catalog #
GS65115
GS65118

Description
Straight, 8-1/2" (21.5 cm)
Angled, 10-1/2" (26.5 cm)

OB/GYN

Biopsy Punches

THOMAS-GAYLOR CERVICAL BIOPSY FORCEPS



213011

Catalog #	Description
213011	Curved shanks, 9-1/4" (23.5 cm)

THOMAS-GAYLOR BIOPSY PUNCH



GS65084

Catalog #	Description
GS65084	Interfitted jaw, 9-1/2" (24 cm)

TISCHLER BIOPSY PUNCHES



GS65186

Catalog #	Description
GS65188	Straight, 3 x 5 mm, 8" (20.5 cm)
GS65186	Straight, 3 x 7 mm, 9" (23 cm)
GS65204	Shaft only, 3 x 7 mm bite
GS65205	Pistol grip handle only for Tischler punch

OB/GYN

Biopsy Punches

WITTNER BIOPSY FORCEPS



752526

8 x 6 mm toothed basket jaw, 8-7/8" (22.5 cm) stem.

Catalog #	Description
752526	Straight, 11-1/2" (29 cm)

Circumcision Clamps

GOMCO® CIRCUMCISION CLAMPS



742110

Catalog #	Description
742100	Extra small, 11 mm
742102	Newborn, 13 mm
742104	Infant, 15 mm
742106	Child, 16 mm
742108	Youth, 21 mm
742110	Adult, 26 mm

OB/GYN

Delivery Forceps

DE LEE OBSTETRICAL FORCEPS



Catalog #
214595

Description
12" (30.5 cm)

MCLEAN-TUCKER-LUIKART OBSTETRICAL FORCEPS



Catalog #
214605

Description
15-1/2" (39.5 cm)

SIMPSON OBSTETRICAL FORCEPS



Catalog #
214550
214555

Description
14" (35.5 cm)
12" (30.5 cm)

SIMPSON-LUIKART OBSTETRICAL FORCEPS



Catalog #
214570

Description
Fenestrated, smooth, 14" (35.5 cm)

OB/GYN

Scissors

BUSCH UMBILICAL SCISSORS



Catalog #
GS67294

Description
Curved sideways, 6-1/2" (16.5 cm)

UMBILICAL SCISSORS



Catalog #
214090
GS67292

Description
4-1/8" (10.5 cm)
Straight, 4-3/8" (11 cm)

BRAUN EPISIOTOMY SCISSORS



Catalog #
214081

Description
Wide lower blade, angled to side, 8-3/4" (22 cm)

OB/GYN

Probes, Sounds and Dilators

EMMETT UTERINE PROBE



212600

Catalog#
212600

Description
Sterling Silver, 11" (28 cm)

SIMPSON UTERINE SOUND



212605

Catalog#
212605

Description
4 mm, graduated in inches, silver plated, malleable,
12-3/4" (32.5 cm)

SIMS UTERINE SOUNDS



212612

Catalog#
212610
212612

Description
4 mm, non-graduated, silver plated, malleable,
12-3/4" (32.5 cm)
4 mm, graduated in cm, malleable, 12-3/4" (32.5 cm)

OB/GYN

Probes, Sounds and Dilators

HANK UTERINE DILATORS



212666

. Pattern, satin finish. Double-ended. Length 10-3/4" (27.5 cm). All sizes available individually.

Catalog #	Description
212659	Hank Uterine Dilators, set of 6, sizes 11-12 Fr. to 21-22 Fr. (3.66 to 7.33 mm)
212661	9-10 Fr. (3 x 3.3 mm)
212662	11-12 Fr. (3.6 x 4 mm)
212663	13-14 Fr. (4.3 x 4.7 mm)
212664	15-16 Fr. (5 x 5.3 mm)
212665	17-18 Fr. (5.7 x 6 mm)
212666	19-20 Fr. (6.3 x 6.7 mm)
212667	21-22 Fr. (7 x 7.3 mm)
212668	23-24 Fr. (7.7 x 8 mm)
212669	25-26 Fr. (8.3 x 8.7 mm)
212670	27-28 Fr. (9 x 9.3 mm)
212671	29-30 Fr. (9.3 x 10 mm)

HANK UTERINE DILATORS

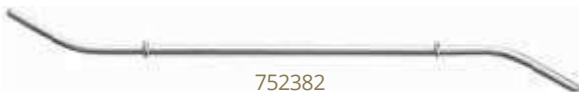

752382

Weck® Pattern, bright finish. Double-ended. End lengths 2-1/2" (6.5 cm). Length 10-3/8" (26.5 cm).

Catalog #	Description
752380	9/10 American (4.5 x 5 mm)
752381	11/12 American (5.5 x 6 mm)
752382	13/14 American (6.5 x 7 mm)
752383	15/16 American (7.5 x 8 mm)
752384	17/18 American (8.5 x 9 mm)
752385	19/20 American (9.5 x 10 mm)

OB/GYN

Probes, Sounds and Dilators

HEGAR UTERINE DILATORS



212673



212678

. Pattern, satin finish. Double-ended, 7-7/8" (20 cm).

Catalog #	Description
212673	Set of 8, sizes 3 mm to 18 mm
212675	Size 3-4 mm
212676	Size 5-6 mm
212677	Size 7-8 mm
212678	Size 9-10 mm
212679	Size 11-12 mm
212680	Size 13-14 mm
212681	Size 15-16 mm
212682	Size 17-18 mm

HEGAR UTERINE DILATORS



752354

Weck® Pattern, bright finish. Double-ended, hollow, 7-7/8" (20 cm).

Catalog #	Description
752338	Size 1/2 mm
752347	Size 19/20 mm
752348	Size 21/22 mm
752349	Size 23/24 mm
752351	Size 25/26 mm
752354	Complete set in case

OB/GYN

Probes, Sounds and Dilators

PRATT UTERINE DILATORS



212647

Catalog #
212647

Pattern, satin finish. Double-ended, 11-5/8" (29.5 cm).
Stainless steel.

Description
Set of 8 in canvas case, sizes 13-15 Fr. to 41-43 Fr.

PRATT UTERINE DILATORS



752394

Weck® Pattern, bright finish. Double-ended,
11-5/8" (29.5 cm).

Catalog #	Description
752390	Size 13-15 Fr.
752391	Size 17-19 Fr.
752392	Size 21-23 Fr.
752393	Size 25-27 Fr.
752394	Size 29-31 Fr.
752395	Size 33-35 Fr.
752396	Size 37-39 Fr.
752397	Size 41-43 Fr.

Curettes

HEANEY BIOPSY CURETTE



212905

Catalog #
212905

Description
9-3/4" (25 cm)

OB/GYN

Curettes

KEVORKIAN-YOUNGE BIOPSY CURETTE



. Pattern.



212910

Catalog #
212910

Description
12-1/8" (31 cm)

KEVORKIAN-YOUNGE CURETTES



Sharp tip.



GS64796

Catalog #

Description

GS64796
GS64802

Without basket, 12" (30.5 cm)
With basket, 12" (30.5 cm)

OB/GYN

Curettes

RANDALL SUCTION BIOPSY CURETTE



Catalog #
GS64808

Description
Sharp, curved, 4 mm diameter, 9-3/4" (25 cm)

GS64808

SIMS UTERINE CURETTES



Sharp blades. Malleable shafts.

Catalog #
212749
212750
212751
212752
212753
212754
212755

Description
Size 0, 10-7/8" (27.5 cm)
Size 1, 11-1/4" (28.5 cm)
Size 2, 11-1/4" (28.5 cm)
Size 3, 11-3/8" (29 cm)
Size 4, 11-1/2" (29 cm)
Size 5, 11-1/2" (29 cm)
Size 6, 11-5/8" (29.5 cm)

212752

OB/GYN

Tenaculums and Vulsellums

ADAIR TENACULUM



Catalog #
213120

Description
6-7/8" (17.5 cm)

BARRETT TENACULUM



Catalog #
213110

Description
7-1/4" (18.5 cm)

BRAUN TENACULUM



Catalog #
213100

Description
9-5/8" (24.5 cm)

OB/GYN

Tenaculums and Vulsellums

DUPLAY TENACULUM



Catalog #
213085

Description
9-7/8" (25 cm)

213085

HULKA TENACULUM AND PROBE



Catalog #
754125

Description
Single tooth, probe 4-3/4" (12 cm) w/ 3.6 mm tip,
11-1/8" (28.5 cm)

754125

JARCHO TENACULUM



Catalog #
213065

Description
8" (20.5 cm)

213065

SCHROEDER TENACULUM



Catalog #
213080

Description
9-7/8" (25 cm)

213080

OB/GYN

Tenaculums and Vulsellums

STAUDE TENACULUM



213090

Catalog #
213090Description
5-3/8" (13.5 cm)

STAUDE-MOORE TENACULUM



213095

Catalog #
213095Description
6-3/8" (16 cm)

WYLIE UTERINE TENACULUM



754160

Catalog #
754160Description
1 x 2 teeth, 9-1/2" (24 cm)

OB/GYN

Tenaculums and Vulsellums

HENROTIN VULSELLUM



213150

Catalog #
213150

Description
8-1/4" (21 cm)

JACOB'S VULSELLUM FORCEPS



213155

Catalog #
213155
213157

Description
Straight, 2 x 2 teeth, 8-1/4" (21 cm)
Curved sideways, serrated, 2 x 2 teeth,
8-1/4" (21 cm)



213157

KELLY VULSELLUM



213160

Catalog #
213160

Description
Curved sideways, 9-1/2" (24 cm)

OB/GYN

Tenaculums and Vulsellums

M.G.H. VULSELLUM



213175

Catalog #
213175Description
3 x 3 teeth, 6-1/8" (15.5 cm)

SCHROEDER VULSELLUM



213180

Catalog #
213180Description
Straight, 9-7/8" (25 cm)

TEALE UTERINE VULSELLUM



754370

Catalog #
754370Description
Curved sideways, 3 x 4 teeth, 9-1/4" (23.5 cm)

OB/GYN

Specula

GRAVES VAGINAL SPECULA



212001

Catalog#	Description
212000	Small blade 3-1/4" (8.5 cm) long x 7/8" (2.2 cm) wide
212001	Medium blade 4-3/8" (11 cm) long x 1-3/8" (3.5 cm) wide
212002	Large blade 5" (13 cm) long x 1-1/2" (3.7 cm) wide
212005	Medium, right open-sided blade 4-3/8" (11 cm) long x 1-3/8" (3.5 cm) wide



212005

OB/GYN

Specula

PEDERSON VAGINAL SPECULA



212011

Narrow, straight side blades.

Catalog #	Description
212010	Small, 3-1/4" x 1/2" (8.5 x 1.5 cm)
212011	Medium, 3-1/4" x 1" (8.5 x 2.5 cm)
212012	Large, 4-3/4" x 1" (12 x 2.5 cm) blades

SLENDER PEDERSON SPECULUM



GS64288

Catalog #	Description
GS64288	Narrow blades, 4-11/32" (110 mm) long x 11/16" (17.5 mm) wide with a 2-7/8" (73 mm) maximum opening

KOGAN ENDOCERVICAL SPECULUM



GS64830

Catalog #	Description
GS64830	With gauge and set screw, 9-1/2" (24 cm)

OB/GYN

Specula

AUVARD WEIGHTED VAGINAL SPECULA



212196

Catalog #	Description
212195	3 lbs., 3" (7.5 cm)
212196	2-1/2 lbs., 3-3/8" (8.5 cm)
212197	3 lbs., 4" (10 cm)

GARRIGUE WEIGHTED VAGINAL SPECULUM



212185

Catalog #	Description
212185	Cut-out handle allows drainage. Blade 1-5/8" x 3-1/8" (4 x 8 cm), weight 2 lbs., chrome plated

HENROTIN WEIGHTED VAGINAL SPECULUM



212187

Catalog #	Description
212187	Blade 1-1/2" x 3-1/2" (3.8 x 9 cm), weight 3 lbs, chrome plated

OB/GYN

Retractors

DE LEE UNIVERSAL RETRACTOR



Catalog #
212350

Description
3" x 2-1/8" (7.5 x 5.5 cm) blade, 9-1/2" (24 cm)

EASTMAN VAGINAL RETRACTORS



Catalog #
212271
212275

Description
1-3/8" x 3-1/4" (3.5 x 8.5 cm)
1-3/8" x 3-7/8" (3.5 x 10 cm)

HEANEY-SIMON VAGINAL RETRACTOR



Catalog #
212305

Description
1-1/8" x 4-3/4" (2.5 x 12 cm), blade length
11" (28 cm)

OB/GYN

Retractors

JACKSON VAGINAL RETRACTORS



212264

Catalog #	Description
212263	1-9/16" x 3-1/4" (4 x 8.5 cm)
212264	1-9/16" x 3-19/32" (4 x 9 cm)
212265	1-19/32" x 4" (4 x 10 cm)

PRYOR-PEAN RETRACTOR



212295

Catalog #	Description
212295	1" x 4-1/2" (2.5 x 11.5 cm), blade length 10-3/8" (26.5 cm)

SIMS VAGINAL RETRACTORS



212228

Double-ended.

Catalog #	Description
212225	7/8" x 2-5/8" (2 x 6.5 cm) and 1" x 3-1/8" (2.5 x 8 cm)
212226	1" x 2-1/2" (2.5 x 6.5 cm) and 1-1/4" x 3" (3 x 7.5 cm)
212227	1" x 3-1/4" (2.5 x 8.5 cm) and 1-3/16" x 3-1/2" (3 x 9 cm)
212228	1-1/4" x 3" (3 x 7.5 cm) and 1-3/8" x 3-1/4" (3.5 x 8.5 cm)
212229	1-3/16" x 3-1/4" (3 x 8.5 cm) and 1-7/16" x 4" (3.5 x 10 cm)

OB/GYN

Retractors

SIMS VAGINAL RETRACTORS



212241

Single-ended.

Catalog #	Description
212241	1-1/8" x 3-5/8" (3 x 9 cm)
212242	1-1/2" x 3-1/2" (4 x 9 cm)

Laser Instruments

BELLINA LASER RULERS

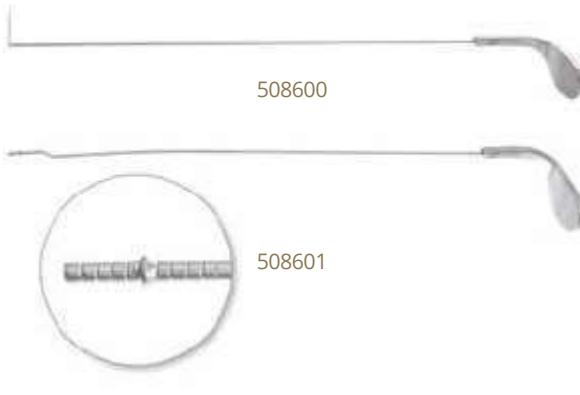

508600

508601

For determining depth and length of tissue for ablation purposes.

Catalog #	Description
508600	Lateral ruler, graduated in millimeters up to 15 mm
508601	Straight ruler, graduated in millimeters with a ridge indicating the 5 mm mark

CERVICAL LASER HOOKS

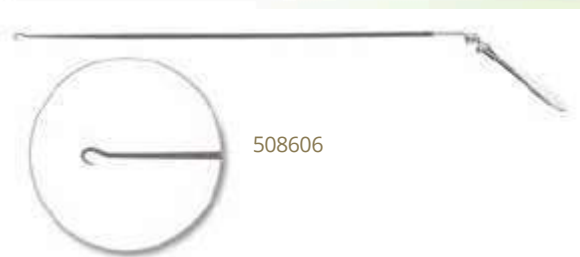

508606

Ebonized for use with laser surgery.

Catalog #	Description
508605	Small, 2 mm hook, 6-1/2" (16.5 cm) working length, overall 9-1/2" (24 cm)
508606	Large, 4 mm hook, 7" (18 cm) working length, overall 9-7/8" (25 cm)

OB/GYN

Laser Instruments

LASER MIRROR



509209

Highly polished stainless steel front surface mirror.
Suction to draw smoke and steam.

Catalog #	Description
509209	6 mm diameter, working length 8-1/4" (21 cm)

MILAN-LONDON VACUUM TUBE



508602

Ebonized for use with laser surgery. Clips onto a standard metal Graves speculum for evacuation of smoke and plume.

Catalog #	Description
508602	4-7/8" (12.5 cm)

OSSOFF MICRO SUCTION TUBE EBONIZED

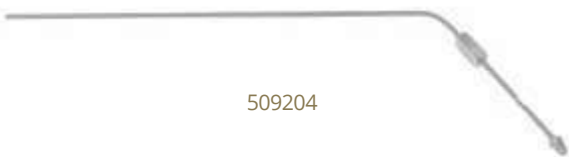

509204

Ebonized for use with laser surgery.

Catalog #	Description
509204	7 Fr., working length 7-7/8" (20 cm)

OB/GYN

Laser Instruments

LASER SPECULA



508610

Inner blades are matte finished to help reduce reflection of the laser beam. External blades are polished stainless steel for ease of insertion. One smoke evacuation tube is on the upper blade for rapid removal of steam and smoke from the ablated tissue. Available in three sizes.

Catalog #	Description
508610	Small, blades 3-1/4" (8.5 cm) long x 7/8" (2.2 cm) wide, suction tube 4-5/8" (12 cm) long (unbent)
508612	Medium, blades 4-3/8" (11 cm) long x 1-3/8" (3.5 cm) wide, suction tube 4-5/8" (12 cm) long (unbent)
508614	Large, blades 5" (13 cm) long x 1-1/2" (3.7 cm) wide, suction tube 5-1/2" (14 cm) long (unbent)

SCHROEDER TENACULUM



508694

Ebonized for use with laser surgery.

Catalog #	Description
508694	10" (25.5 cm)

THOMS-ALLIS VULSELLUM FORCEPS



508696

Ebonized for use with laser surgery.

Catalog #	Description
508696	Straight, 6 x 7 Teeth, 8" (20.5 cm)

OB/GYN

Miscellaneous

BETHEA SHEET HOLDERS



214770

Catalog #
214770Description
1" (2.5 cm) wide, 5" (12.5 cm) diameter

IOWA TRUMPET NEEDLE GUIDE

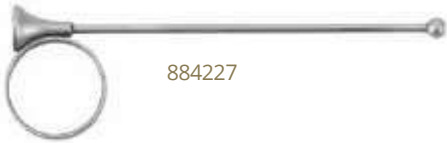

884227

For paracervical anesthesia.

Catalog #
884227Description
Ball tip 7 mm, 5-1/2" (14 cm)

OB/GYN

Forceps and Clamps

BOZEMAN UTERINE DRESSING FORCEPS

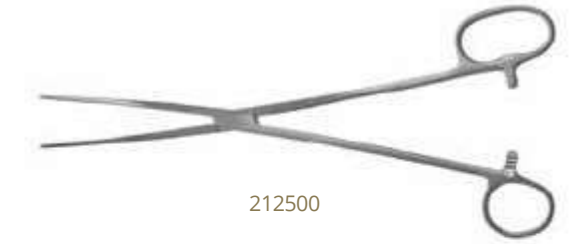

212500

Catalog #
212500
212505

Description
Double-curved, one large ring, 10-1/4" (26 cm)
Standard model, curved, 10-1/4" (26 cm)



212505

DE LEE CERVICAL GRASPING FORCEPS



213050

Catalog #
213050

Description
10" (25.5 cm)

KELLY PLACENTA CLAMP

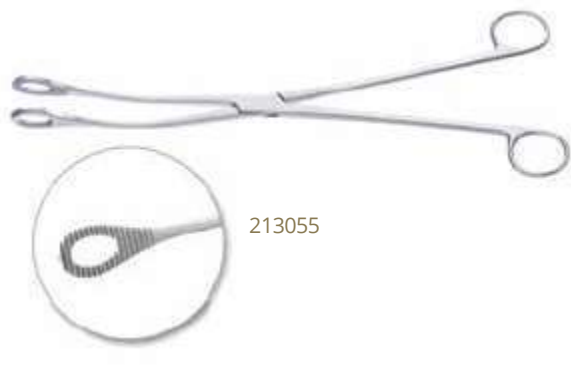

213055

Catalog #
213055

Description
12-5/8" (32 cm)

OPHTHALMIC INSTRUMENTS

FORCEPS

Dressing Forceps

BISHOP-HARMON DRESSING FORCEPS



427392



GS53428

3-3/8" (8.5 cm).

Catalog #	Description
425350	Extra delicate, serrated, 0.4 mm tip
GS53426	Extra delicate, serrated, 0.7 mm tip
427392	Delicate, cross-serrated, 0.9 mm tip
GS53428	Delicate, serrated, 1 mm tip

DRESSING FORCEPS



427400



427410

Delicate, serrated, 3-7/8" (10 cm).

Catalog #	Description
427400	Straight tip
427410	Lightly curved tip

FORCEPS

Dressing Forceps

GRAEFE EYE DRESSING FORCEPS



GS53420

Catalog #
GS53404
GS53408
GS53420
GS53422

Description
Straight, serrated, 0.9 mm tip, 2-7/8" (7 cm)
Curved, serrated, 1.2 mm tip, 2-1/2" (6.5 cm)
Straight, 1 x 2 teeth, 0.9 mm tip, 2-7/8" (7 cm)
Curved, 1 x 2 teeth, 1 mm tip, 2-1/2" (6.5 cm)



GS53404



GS53408

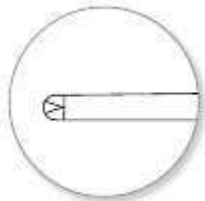

GS53420

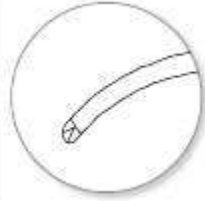

GS53422

FORCEPS

Tissue Forceps

BISHOP-HARMON TISSUE FORCEPS



427390

1 x 2 teeth, 3-3/8" (8.5 cm).

Catalog #	Description
425360	0.4 mm
427390	tip 0.7
GS53440	mm tip
	1.0 mm
	tip

BONN IRIS TISSUE FORCEPS



425390

Catalog #	Description
425380	Long model, 0.12 mm tip, 2-3/4" (7 cm)
425390	Tying platform, 1 x 2 teeth, 3-3/4" (10 cm)

CASTROVIEJO-COLIBRI TISSUE FORCEPS



425312

Catalog #	Description
425312	Curved tip, 1 x 2 teeth, 0.12 mm tip, 4-3/8" (11 cm)

COLIBRI CORNEAL TISSUE FORCEPS



425590

Catalog #	Description
425590	1 x 2 teeth, 0.12 mm tip, 3" (8 cm)

FORCEPS

Tissue Forceps

MCPHERSON TISSUE FORCEPS



425560

Catalog # 425560
Description 1 x 2 teeth, 3-1/2" (9 cm)

TISSUE FORCEPS



427420

Catalog # 427420
Description Straight, delicate, 1 x 2 teeth, 3-7/8" (10 cm)

TROUTMAN-BARRAQUER TISSUE FORCEPS



Catalog # G553460
Description Tying platform, 1x2teeth, 0.3mm tip, 2-7/8" (7.5cm)



G553460

FORCEPS

Tying Forceps

CASTROVIEJO SUTURE FORCEPS



427370

With tying platform, 1 x 2 teeth, straight, 3-7/8" (10 cm).

Catalog #	Description
427384	0.12 mm
427370	0.3 mm
427382	tip 0.5 mm tip

KELMAN-MCPHERSON FORCEPS



425605

With tying platform, angled.

Catalog #	Description
425605	3-1/4" (8.5 cm)

MCPHERSON TYING FORCEPS



425200

With tying platform, smooth, 3-1/4" (8.5 cm).

Catalog #	Description
425200	Straight
425210	Angled



425210

MICRO-TYING FORCEPS



GS44012

With tying platform.

Catalog #	Description
GS44012	Straight, 0.3 mm tip, 4-3/8" (11 cm)

FORCEPS

Tying Forceps

PLATFORM TYING FORCEPS



With tying platform.

Catalog #	Description
GS44014	0.7 mm tip, 5-1/2" (14 cm)



GS44014

TENNANT TYING FORCEPS



425190

With tying platform, smooth, round handle, 4" (10 cm).

Catalog #	Description
425190	Straight
425191	Curved



425191

TEW TYING FORCEPS



With tying platform, straight jaw with longitudinal serrations, 7-1/8" (18 cm).

Catalog #	Description
394430	0.5 mm tip
394431	1 mm tip



394430

FORCEPS

Jeweler's Forceps

JEWELER'S FORCEPS



425700



425710



425720



425730



425740



425750

Catalog #	Description
425700	#1, 4-3/4" (12 cm)
425710	#3, 4-3/4" (12 cm)
425720	#3-C, 4-3/8" (11 cm)
425730	#4, 4-1/4" (10.8 cm)
425740	#5, 4-1/4" (10.8 cm)
425750	#7, 4-5/8" (11.5 cm)

FORCEPS

Cilia Forceps

BARRAQUER CILIA AND SUTURE FORCEPS



Catalog #
GS53580

Description
Smooth platform, 4-1/2" (11.5 cm)



GS53580

BERGH CILIA FORCEPS



Catalog #
GS53568

Description
Finely serrated, 3-1/2" (9 cm)



GS53568

DOUGLAS CILIA FORCEPS



Catalog #
GS53560

Description
Finely serrated, 3-1/2" (9 cm)



GS53560

FORCEPS

Cilia Forceps

LITTAUER CILIA FORCEPS



GS53564

Catalog #
GS53564

Description
Finely serrated, 3-1/2" (9 cm)

ZIEGLER CILIA FORCEPS



Catalog #
GS53574

Description
Smooth, 3-1/2" (9 cm)



GS53574

Chalazion Forceps

DESMARRES CHALAZION FORCEPS



GS53688

3-1/2" (9 cm).

Catalog #
GS53686
GS53688
GS53690

Description
20 mm wide tip
24 mm wide tip
30 mm wide tip

FORCEPS

Columella Forceps

COTTLE COLUMELLA FORCEPS



Catalog #
443480

Description
1/2" (12 mm) tip, 4-3/8" (11 cm)



443480

Fixation Forceps

GRAEFE FIXATION FORCEPS



5 x 6 teeth, 4-1/4" (10.5 cm).

Catalog #
GS53480
GS53484

Description
Without catch
With catch



GS53480



GS53484

Scleral Forceps

CASTROVIEJO CORNEO-SCLERAL FORCEPS



425520

Tying platform, 1 x 2 teeth, 4-3/8" (11 cm).

Catalog #
425510
425520
425530

Description
0.12 mm tip
0.3 mm tip
0.5 mm tip

SCISSORS

Spring Handle

CASTROVIEJO KERATOPLASTY SCISSORS



423330

Flat handle, angled 45 degrees, 3-7/8" (10 cm).

Catalog #	Description
423330	Very delicate, 1.4 mm tip
423340	Blunt tip

CASTROVIEJO KERATOPLASTY MICRO-SCISSORS



423320

Flat handle, angled 45 degrees, 3-7/8" (10 cm).

Catalog #	Description
423320	Very delicate

CASTROVIEJO SCISSORS



352145

Spring handle for maximum control. Angled 45 degrees.

Catalog #	Description
352145	9 mm blades, 4-1/8" (10.5 cm)

SCISSORS

Spring Handle

MCCLURE IRIS SCISSORS



Angled on flat for increased control and visibility.

Catalog #	Description
144295	4-3/4" (12 cm)
352144	12 mm blades, 4-1/2" (11.5 cm)

MICRO-REILL SCISSORS



Flat handle.

Catalog #	Description
GS44022	Serrated, curved, 5-1/2" (14 cm)

MICRO-SPRING SCISSORS



Flat handle, 6" (15 cm).

Catalog #	Description
GS44253	Straight, 9 mm blades
GS44251	Curved, 9 mm blades
GS44252	Straight, 14 mm blades
GS44250	Curved, 14 mm blades

SCISSORS

Spring Handle

FINE STITCH SCISSORS



Catalog #	Description
423422	4-5/8" (11.5 cm)

VANNAS SCISSORS

Very delicate, flat handle, 3-3/8" (8.5 cm).



Catalog #	Description
GS44263	Straight
GS44262	Curved
GS44261	Angled
GS44260	Angled on flat

VANNAS CAPSULOTOMY SCISSORS



3-3/8" (8.5 cm).

Catalog #	Description
423450	Straight
423460	Curved

SCISSORS

Spring Handle

WESTCOTT MICRO-TENOTOMY SCISSORS



GS44272

Flat handle, 10 mm blade, 4" (10 cm).

Catalog #	Description
GS44270	Curved, blunt
GS44271	Curved, sharp
GS44272	Straight, blunt
GS44273	Straight, sharp

WESTCOTT STITCH SCISSORS



423410

Catalog #	Description
423410	4-3/4" (12 cm)

WESTCOTT TENOTOMY SCISSORS



GS44275

Flat handle.

Catalog #	Description
GS44274	Curved, blunt, 4-3/4" (12 cm)
GS44275	Curved, sharp, 4-3/4" (12 cm)
GS44276	Straight, blunt, 4-3/4" (12 cm)
GS44277	Straight, sharp, 4-3/4" (12 cm)
423480	Curved right, 4-1/2" (11.5 cm)
423490	Curved left, 4-3/4" (12 cm)



423480



SCISSORS

Spring Handle

HEPP-SCHEIDEL DISSECTING SCISSORS



Round handle.

Catalog #	Description
GS44024	Curved, 5-1/2" (14 cm)



GS44024

DIGITATE-HEIFETZ SCISSORS



Catalog #	Description
066100	Straight, 5-3/4" (14.5 cm)
066102	Curved, 5-3/4" (14.5 cm)
066104	Straight, 4-3/4" (12 cm)

066100



066102

IRIS SCISSORS WITH BARRAQUER HANDLE



Round handle.

Catalog #	Description
055502	Curved, 18 mm blades, 5-3/4" (14.5 cm)



055502

SCISSORS

Spring Handle

MICRO-SPRING SCISSORS



GS44018



GS44018



GS44020



GS44255



GS44254

Catalog #	Description
GS44018	Straight, 11 mm blade, 5-1/2" (14 cm)
GS44020	Curved, 11 mm blade, 5-1/2" (14 cm)
GS44257	Straight, 9 mm blade, 6" (15 cm)
GS44255	Curved, 9 mm blade, 6" (15 cm)
GS44256	Straight, 14 mm blade, 6" (15 cm)
GS44254	Curved, 14 mm blade, 6" (15 cm)

SCISSORS

Ring Handle

MINIATURE EYE SCISSORS



3-1/2" (9 cm).

Catalog #	Description
423428	Straight
423430	Curved

EYE SCISSORS



Delicate, 4" (10 cm).

Catalog #	Description
423432	Straight
423434	Curved

EYE SCISSORS



Standard, large rings.

Catalog #	Description
423438	Curved, 4-1/2" (11.5 cm)

SCISSORS

Ring Handle

GRADLE SCISSORS



Slightly curved, Sharp/Sharp.

Catalog #	Description
GS53316	3-3/4" (9.5 cm)
GS53318	Ribbon type, 4" (10 cm)

IRIS MINIATURE SCISSORS



Round handle, 15 mm blades, 3-1/2" (9 cm).

Catalog #	Description
055100	Straight
055102	Curved

SCISSORS

Ring Handle

IRIS RIBBON SCISSORS



GS53267

Slightly curved, Sharp/Sharp.

Catalog #	Description
GS53265	3-3/4" (9.5 cm)
GS53267	4" (10 cm)

LITTLER DISSECTING SCISSORS



423425

Round handle.

Catalog #	Description
423425	Curved, 1 mm dia. hole, 4-5/8" (12 cm)

STITCH SCISSORS



423440

Slightly curved, needle points.

Catalog #	Description
423440	Slightly curved, needle points, 3-3/4" (9.5 cm)

NEEDLE HOLDERS

BARRAQUER NEEDLE HOLDERS



424180

Delicate, 5-1/4" (13 cm).

Catalog #	Description
424170	Straight, without lock
424180	Curved, with lock
424190	Curved, without lock



424190

CASTROVIEJO NEEDLE HOLDERS



424100

Delicate.

Catalog #	Description
424100	Straight, with lock, 5-3/4" (14.5 cm)
424102	Straight, without lock, 5-1/4" (13 cm)
424110	Curved, with lock, 5-1/4" (13 cm)

DIGITATE-HEIFETZ NEEDLE HOLDERS



066200

066204





Round handle, 5-7/8" (15 cm).

Catalog #	Description
066200	Straight, without lock, 0.4 mm
066204	Curved, without lock, 0.6 mm

HOOKS

Strabismus Hooks

GRAEFE STRABISMUS HOOKS

Image	Catalog #	Description
 <p data-bbox="451 493 537 520">GS54332</p>	GS54330	Small, 5-1/8" (13 cm)
 <p data-bbox="451 619 537 646">GS54330</p>	GS54332	Medium, 5-1/2" (14 cm)
 <p data-bbox="451 772 537 800">GS54332</p>	GS54334	Large, 5-1/2" (14 cm)
 <p data-bbox="451 926 537 953">GS54334</p>		

HOOKS

Muscle Hooks

JAMESON MUSCLE HOOK



421200

Catalog #
421200

Description
5-1/4" (13.5 cm)

O'CONNOR HOOK



422250

Catalog #
422250

Description
4-7/8" (12.5 cm)



VON GRAEFE STRABISMUS HOOKS



422190

Catalog #
422180
422190
422200

Description
Size 1, 8.5 mm hooks, 5-1/8" (13 cm)
Size 2, 10.5 mm hooks, 5-3/8" (13.5 cm)
Size 3, 12.5 mm hooks, 5-1/2" (14 cm)

CURETTES

MEYHOEFFER CURETTES

	GS54309	Catalog # GS54307	Description Size 00, 1.0 mm
	GS54307	GS54309 GS54311 GS54313	Size 0, 1.5 mm Size 1, 1.7 mm Size 2, 2.0 mm
	GS54309		GS54309
	GS54311		GS54311
	GS54313		GS54313

KNIVES

NUCLEUS KNIFE



GS69524

Catalog #
GS69524

Description
#71, small, 5-1/4" (13.5 cm)

SPECULA

BARRAQUER WIRE SPECULUMS

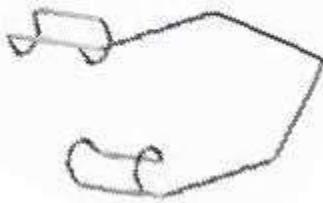

421512

Catalog #
421510
421512
GS54108

Description
Blades 4 mm wide, 1-1/8" (3 cm)
Blades 6 mm wide, 1-5/8" (4 cm)
Blades 10 mm wide, 1-3/4" (4.5 cm)

GRAEFE EYE SPECULUM



GS54080

Catalog #
GS54080

Description
3-1/2" (9 cm)

LACRIMAL PROBES/DILATORS

BOWMAN LACRIMAL PROBES



426096

Sterling Silver, 4-7/8" (12.5 cm).

Catalog #	Description
426090	Size 0000-000
426092	Size 00-0
426094	Size 1-2
426096	Size 3-4
426098	Size 5-6
427002	Size 7-8

WILLIAMS LACRIMAL PROBES



166490

5-1/8" (13 cm).

Catalog #	Description
166480	Size 1-2
166485	Size 3-4
166490	Size 5-6
166495	Size 7-8

LACRIMAL PROBE



426010

Disposable.

Catalog #	Description
426010	4-5/8" (11.5 cm)

LACRIMAL PROBES/DILATORS

CASTROVIEJO LACRIMAL DILATOR



Catalog #
426080

Description
Double-ended, one medium taper and one needle point, 5-1/2" (14 cm)

WILDER LACRIMAL DILATORS



4-3/8" (11 cm).

Catalog #
426040
426050

Description
Long taper, fine tip
Medium taper, medium tip



EYE SPUDS/NEEDLES

DIX SPUD AND NEEDLE



Catalog #
GS54272

Description
Spud and needle (not pictured) in reversible screw handle

FOREIGN BODY NEEDLES AND SPUDS



Catalog #
GS54280
GS54282
GS54284

Description
Needle, 2 x 5 mm blade, 5" (12.5 mm)
Davis, 0.8 mm blade, 4-3/4" (12 cm)
Ellis, 1.2 mm blade, 4-1/2" (11.5 cm)



IRRIGATION CANNULA

LACRIMAL CANNULA



429526

Catalog #
429526
429527

Description
23 gauge, curved, 1-7/8" (4.8 cm)
23 gauge, straight, 2" (5 cm)

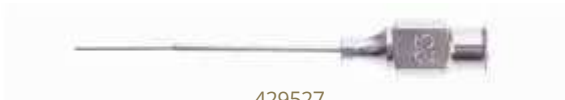

429527

AIR INJECTION CANNULA



429548

5 mm tip angled 45 degrees, 3/4" (2 cm).

Catalog #
429546
429548

Description
27 Ga. 30
Ga.

HEALON INJECTION CANNULA



429566

Catalog #
429566

Description
21 Ga., 5 mm tip angled 50 degrees, 1-1/8" (2.9 cm)

SHEPPARD INCISION IRRIGATION CANNULA



428650

Tip angled 45 degrees, 1-3/8" (3.5 cm).

Catalog #
428655
428650

Description
27 Ga. 30
Ga.

IRRIGATION CANNULA

TROUTMAN ALPHA-CHYMOTRYPSIN CANNULA



429512

Catalog #
429512

Description
25 Ga., curved tip, 1-3/4" (4.5 cm)

BISHOP HARMON ANTERIOR CHAMBER IRRIGATION CANNULA



429520

Catalog #
429520
429534
429524
429532

Description
19 Ga., with squeeze bulb and adapter
Silicone squeeze bulb only, 2-1/4" (5.5 cm)
Cannula only, 19 Ga., angled 7 mm, flattened tip
Adapter only, 1-1/8" (3 cm)

CALIPERS

CASTROVIEJO CALIPER



Catalog #
428630

Description
0-20 mm scale, 3-3/8" (8.5 cm)

CUTTING BLOCK

CUTTING BLOCK



Catalog #
411331

Description
Made of POM (polyoxymethylene), 3" x 1-1/2" x 3/8"
(7.5 x 4 x 1 cm)

PLASTER CAST INSTRUMENTS

PLASTER CAST INSTRUMENTS

BRUNS SHEARS

ORTHOPEDIC INSTRUMENTS



GS46090

For heavier plaster.

Catalog #	Description
GS46090	One blade serrated, 9-3/8" (24 cm)

STILLE PLASTER SHEARS



GS46156

For cast removal.

Catalog #	Description
GS46156	15" (38 cm)

PEDIATRIC CAST BREAKER



GS46188

Catalog #	Description
GS46188	7" (18 cm)

PLASTER CAST INSTRUMENTS

WOLFF (BOEHLER) CAST BREAKERS

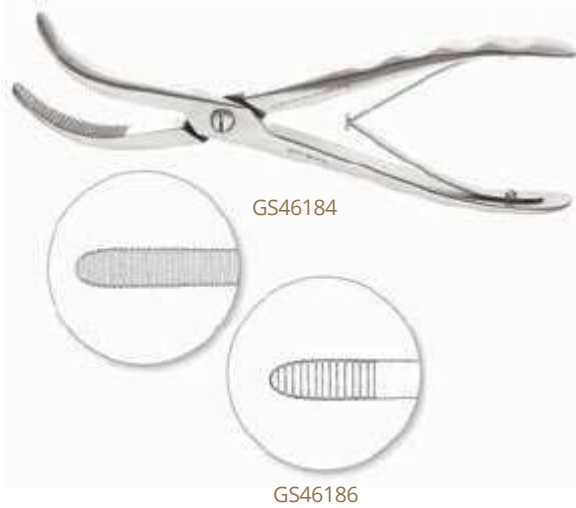

Catalog #	Description
GS46186	Small, 7" (18 cm)
GS46184	9-7/8" (25 cm)

HENNIG PLASTER SPREADER



To relieve cast pressure or for cast removal.
One-handed operation.

Catalog #	Description
GS46138	10-5/8" (27 cm)

REINER PLASTER KNIFE



Stainless handle.

Catalog #	Description
GS46058	7" (18 cm)

PLASTER CAST INSTRUMENTS

ORTHOPEDIC INSTRUMENTS

CAST SPREADER



GS46134

To relieve cast pressure or for cast removal.
One-handed operation.

Catalog #	Description
GS46134	8-7/8" (22.5 cm)

WALTON CAST SPREADER



GS46133

To relieve cast pressure or for cast removal.
One-handed operation.

Catalog #	Description
GS46133	8-5/8" (22 cm)

ENGEL PLASTER SAW



GS46056

Chrome handle and stainless blade.

Catalog #	Description
GS46056	6" (15 cm)

PLIERS

PLIERS

Pliers

NARROW NOSE WIRE PULLING FORCEPS



GS48253

Extra heavy jaws for pulling K-Wires and Steinmann Pins. An economical alternative to double action pliers. Jaw tapers to 3 mm.

CATALOG #	Description
GS48253	3 mm tip, 7-1/2" (19 cm)

NEEDLE NOSE PLIERS



GS48242

Delicate needle nose jaws specifically designed to handle cerclage wire. Jaw tapers to 1 mm.

CATALOG #	Description
GS48242	Delicate, 5-3/8" (13.5 cm)

PLIERS

Pliers

ORTHOPEDIC INSTRUMENTS

NEEDLE NOSE PLIERS



Jaw tapers to 2 mm, making it easier to get close to the bone to remove K-Wires.

CATALOG #	Description
GS48245	5-3/8" (13.5 cm)

LONG JAW NEEDLE NOSE PLIERS



Long delicate jaws are 2 mm at the tip. Perfect for pulling K-Wires, especially in hard-to-reach sites.

CATALOG #	Description
GS48250	Parallel grooved 2" (50 mm) long jaws, 1.5 mm tip, 7" (18 cm)

PLIERS

Pliers

FLAT NOSE PLIERS



Delicate jaws taper to 2 mm. Made to twist and bend cerclage wire.

CATALOG #	Description
GS48248	Delicate, 2 mm tip, 6" (15 cm)

FLAT NOSE PLIERS



Combination plier and cutter. Cuts all sizes (0.2 mm to 1.5 mm) of cerclage wire. Jaws taper to 3.5 mm.

CATALOG #	Description
GS48243	6-1/2" (16.5 cm)

PLIERS

Pliers

ORTHOPEDIC INSTRUMENTS

FLAT NOSE PLIERS



For wire manipulation.

CATALOG #	Description
GS48246	Broad, 4 mm tip, 5-3/8" (13.5 cm)

PIN PULLING PLIERS



Tungsten carbide inserts and grooved opposing jaw design grips small pins securely. Small size is well suited for hand procedures. Jaws are 3 mm at tip.

CATALOG #	Description
GS46578	5-1/2" (14 cm), TC

SCREW REMOVAL FORCEPS



Useful for removing 3.0 mm to 4.5 mm screws.

CATALOG #	Description
GS49920	7" (18 cm), with speed lock, TC

PLIERS

Pliers

K-WIRE EXTRACTION PLIERS



GS48257

With screw lock.

CATALOG #	Description
GS48257	3 mm tip, 5" (13 cm)
GS48258	4 mm tip, 7" (18 cm)

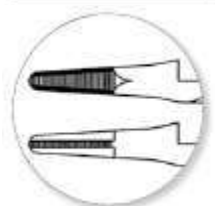

GS48257



GS48258

WIRE BENDING PLIERS



GS48269

CATALOG #	Description
GS48269	5-7/8" (15 cm)

PLIERS

Pliers

ORTHOPEDIC INSTRUMENTS

MULIP JOINT PLIERS



GS48262

Traditional design utility pliers with adjustable jaws. Good all-purpose plier for handling Steinmann Pins, K-Wires, screws and rods. 10 mm jaw tip.

CATALOG #	Description
GS48262	Maximum opening 2" (5 cm), 8" (20.5 cm)

FLAT NOSE K-WIRE PLIERS



GS48256

Multi-purpose plier with flat jaws that taper to 6 mm for pulling K-Wire.

CATALOG #	Description
GS48254	6 mm tip, with side groove for cerclage wire, 6-3/4" (17 cm)
GS48256	6 mm tip, 6-3/4" (17 cm)

LINEMAN PLIERS

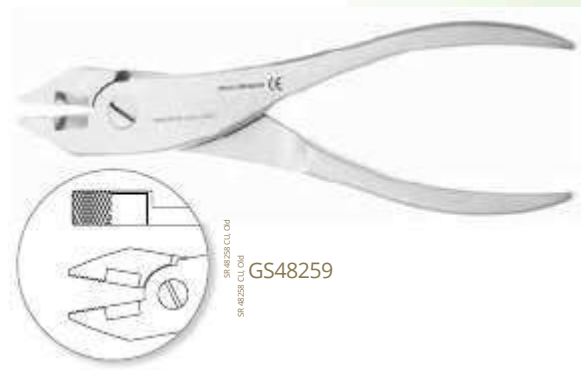

GS48259

Combination pliers and K-Wire Cutter. An economical general purpose instrument with cutting edge.

CATALOG #	Description
GS48259	Side cutting, maximum capacity .062" (1.6 mm), 8-1/2" (21.5 cm)

PLIERS

Pliers

DOUBLE ACTION WIRE EXTRACTION PLIERS



- Recommended for heavy use. Double action and finely serrated carbide tips combine to provide a powerful grip on K-Wires and pins.
- 2 mm tip is ideal for removing K-Wire up to 0.62 mm from small, hard-to-reach sites.
- 4 mm and 6 mm jaws are ideal for grasping and pulling all sizes of K-Wires and pins.
- 7-1/4" (18.5 cm).

CATALOG #	Description
GS46572	2 mm delicate jaw, TC
GS46573	4 mm jaw, TC
GS46574	TC 6 mm jaw, TC

PARALLEL PLIERS



Parallel grooved 10 mm jaws provide enormous gripping power. Ideal for pin removal.

CATALOG #	Description
GS48604	Maximum opening 1/2", 7-1/4" (18.5 cm)

PLIERS

Pliers

ORTHOPEDIC INSTRUMENTS

PARALLEL PLIERS WITH CUTTER



Combination pliers and wire cutter has all the benefits of our Parallel Pliers plus a cutting jaw for K-Wires up to 0.062" (1.6 mm).

CATALOG #	Description
GS48605	Maximum capacity .062" (1.6 mm), 7" (18 cm)

PLIERS

Locking Pliers

HEAVY DUTY LOCKING PLIERS

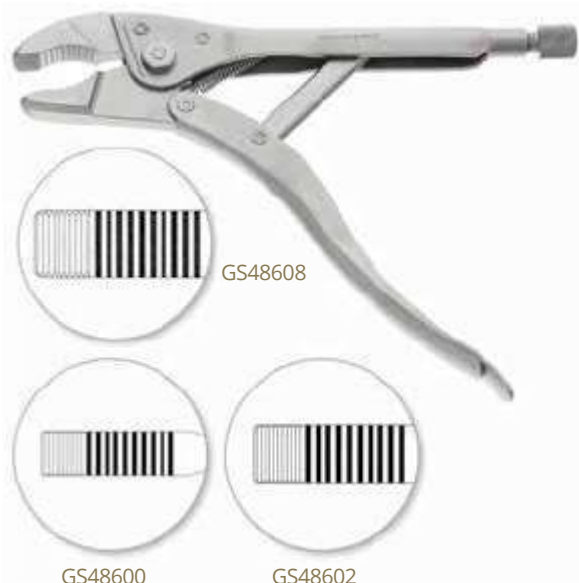

With a new, reinforced, more durable jaw.

- Heavy duty jaws lock securely on top pins.
- Reinforced jaw hinge and housing are more rigid to help prevent side to side shifting.
- Made from 300 and 400 series surgical grade stainless steel.
- Will not chip or contaminate other instrumentation.
- Adjustment screw for easy control of jaw opening.
- One-handed, quick release self-locking lever.
- Available in three sizes.

CATALOG #	Description
GS48600	Small, 7 mm wide tip, maximum opening 1" (25 mm), 6-3/4" (17 cm)
GS48602	Medium, 9 mm wide tip, maximum opening 1" (25 mm), 8" (20.5 cm)
GS48608	Large, 13 mm wide tip, maximum opening 1-1/2" (38 mm), 10" (25.5 cm)

NEEDLE NOSE LOCKING PLIERS



With a new reinforced, more durable jaw.

- New 12" model has an impressive, powerful jaw. The body is made from 2.5 mm stainless steel. This plier will hold up better in the OR than any other needle nose plier – we guarantee it!
- Both pliers have a more durable, reinforced jaw hinge and housing which helps keep the ends in alignment, especially when the plier is twisted.
- Other features: one tapered "V" grooved jaw which locks securely onto pins; adjustment screw; and one-handed, quick release self-locking lever.
- Pliers are made from 300 and 400 series surgical grade stainless steel. Unlike "hardware store" quality, they will not chip or contaminate other instrumentation.

CATALOG #	Description
GS48606	9-1/2" (24 cm)
GS48610	Large, 12" (30.5 cm)



PLIERS

Locking Pliers

ORTHOPEDIC INSTRUMENTS

LOCKING PLIERS WITH SLAPHAMMERS



GS48616



GS48620

A powerful combination of locked gripping strength and controlled hammer action.

- These stainless steel heavy duty locking pliers with slaphammers enable surgeons to more easily extract prostheses, intramedullary nails and hip fracture plates.
- The large pliers offer maximum versatility – slaphammers can be attached in three places; on the end or on either side. Small and medium pliers have end attachments only.
- If additional force is required, a mallet may be used on the hammer plate.

CATALOG #	Description
GS48614	Medium, end attachment only, 8" (20.5 cm)
GS48616	Large, end and side attachments, 10" (25.5 cm)
GS48620	Needle Nose Locking Pliers, medium, end attachment only, 9-1/2" (24 cm)
GS48622	Needle Nose Locking Pliers, large, end and side attachments, 12" (30.5 cm)

PLIERS

Plate Bending Pliers

BENDING PLIERS



GS47931

For 1.5 mm and 2.0 mm plates.

CATALOG #	Description
GS47931	5-3/4" (14.5 cm)

MINI PLATE BENDING PLIERS

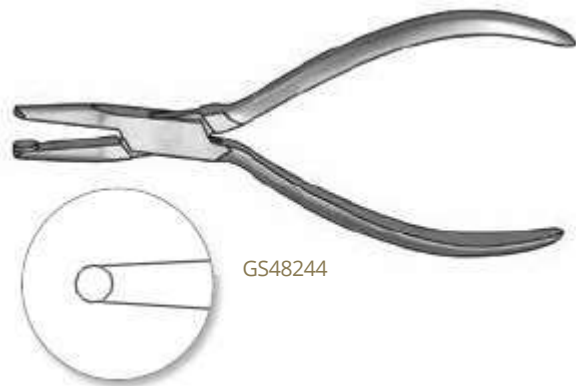

GS48244

For 1.5 mm and 2.0 mm plates.

CATALOG #	Description
GS48244	5-1/8" (13 cm)

PLATE BENDING PLIERS



GS47927

For reconstruction plates.

CATALOG #	Description
GS47927	9-3/8" (23.5 cm)

PLIERS

Plate Bending Pliers

ORTHOPEDIC INSTRUMENTS

SMALL PLATE BENDING PLIERS



For 2.7 mm and 3.5 mm plates.

CATALOG #	Description
GS47925	7-5/8" (19.5 cm)



GS47925

PLATE BENDING PRESS



CATALOG #	Description
GS47929	13-3/4" (35 cm)

GS47929

PLIERS

Socket Wrenches

COMBINATION WRENCH



GS45412

CATALOG #
GS45412 Description
11 mm, 5-1/2" (14 cm)

SOCKET WRENCH



GS47912

CATALOG #
GS45410 Description
11 mm, 7-3/4" (20 cm)
GS47912 Chrome vanadium, 11 mm, 6-3/4" (17 cm)

WRENCH



GS47914

For tightening 8 mm nuts.

CATALOG #
GS47914 Description
5-7/8" (15 cm)

TITANIUM INSTRUMENTS

TITANIUM INSTRUMENTS FORCEPS AND CLAMPS

Tissue and Dressing Forceps

ADSON TITANIUM DRESSING FORCEPS



359361

Flat handle.

Catalog #
359361

Description
Serrated tip, 4-3/4" (12 cm)

ADSON TITANIUM TISSUE FORCEPS

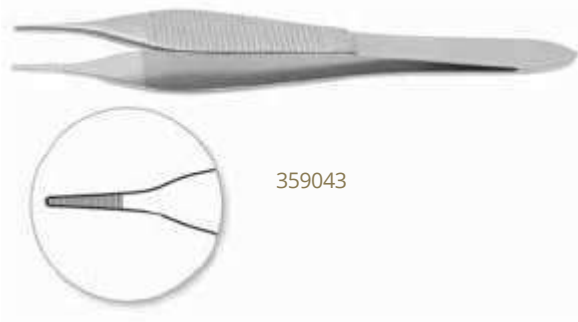

359043

Flat handle.

Catalog #
359043

Description
Serrated tip, 4-3/4" (12 cm), TC

ADSON-BROWN TITANIUM TISSUE FORCEPS



359359

Flat handle.

Catalog #
359359

Description
9 x 9 teeth, 4-3/4" (12 cm)

TITANIUM INSTRUMENTS

FORCEPS AND CLAMPS

Tissue and Dressing Forceps

BARRAYA TITANIUM TISSUE FORCEPS



359053

Flat handle.

Catalog #	Description
359053	2 x 3 teeth, 7-3/4" (20 cm)

CUSHING TITANIUM DRESSING FORCEPS



359052

Flat handle.

Catalog #	Description
359052	Serrated, 7-1/8" (18 cm), TC

CUSHING TITANIUM TISSUE FORCEPS

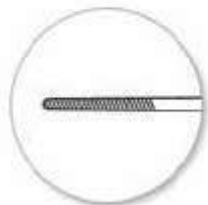

359360

Flat handle.

Catalog #	Description
359360	Serrated, 7-7/8" (20 cm)

TITANIUM INSTRUMENTS FORCEPS AND CLAMPS

Tissue and Dressing Forceps

DEBAKEY® TITANIUM TISSUE FORCEPS



Flat handle.

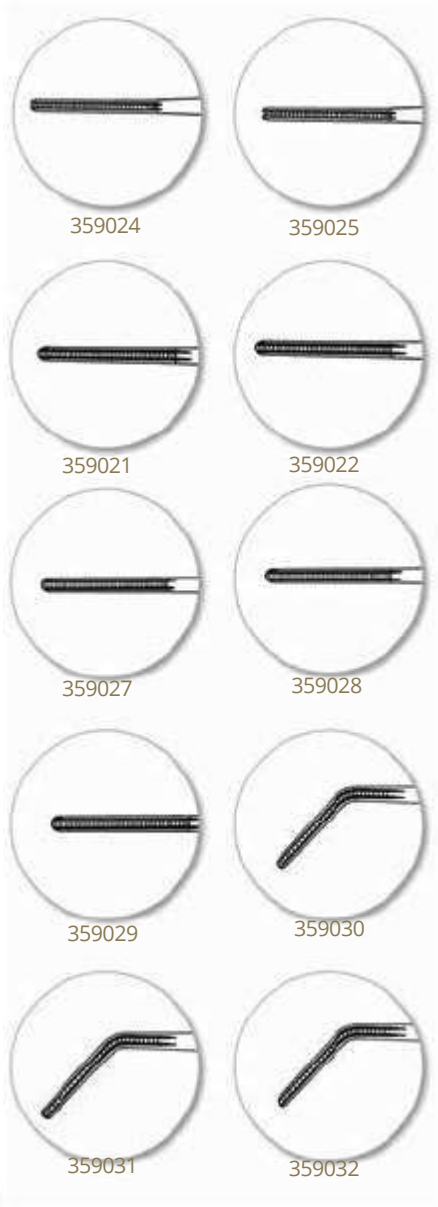

Catalog #	Description
359024	Straight, 1.5 mm jaw width, 6" (15 cm)
359025	Straight, 1.5 mm jaw width, 7-5/8" (19.5 cm)
359021	Straight, 2.5 mm jaw width, 6" (15 cm)
359022	Straight, 2.5 mm jaw width, 7-5/8" (19.5 cm)
359027	Straight, 3 mm jaw width, 6" (15 cm)
359028	Straight, 3 mm jaw width, 7-5/8" (19.5 cm)
359029	Straight, 3 mm jaw width, 9-1/2" (24 cm)
359030	Angled, 2.5 mm jaw width, 5-7/8" (15 cm)
359031	Angled, 2.5 mm jaw width, 7-1/2" (19 cm)
359032	Angled, 2.5 mm jaw width, 9-1/4" (23.5 cm)

TITANIUM INSTRUMENTS

FORCEPS AND CLAMPS

Tissue and Dressing Forceps

GERALD TITANIUM DRESSING FORCEPS



Flat handle. Serrated tip.

Catalog #	Description
359048	6 7/8" (18 cm)



359048

GERALD TITANIUM TISSUE FORCEPS



Flat handle. Serrated tip.

Catalog #	Description
359049	1 x 2 teeth, 6-7/8" (18 cm)



359049

GILLIES TITANIUM TISSUE FORCEPS



Flat handle.

Catalog #	Description
359051	1 x 2 teeth, 5-7/8" (15 cm)



359051

TITANIUM INSTRUMENTS

FORCEPS AND CLAMPS

Tissue and Dressing Forceps

GUILMET TITANIUM DRESSING FORCEPS



359054

Flat handle.

Catalog #
359054

Description
Serrated tip, 7-7/8" (20 cm)

MCINDOE TITANIUM TISSUE FORCEPS



359050

Flat handle.

Catalog #
359050

Description
Serrated tip, 5-7/8" (15 cm)

Micro Forceps

DENIS TITANIUM MICRO FORCEPS



359407

Catalog #
359407

Description
Straight, 0.4 mm tip, Diama-Grip jaws,
8-1/4" (21 cm)

TITANIUM INSTRUMENTS

FORCEPS AND CLAMPS

Micro Forceps

MICRO TITANIUM DIAMA-GRIP TYING FORCEPS

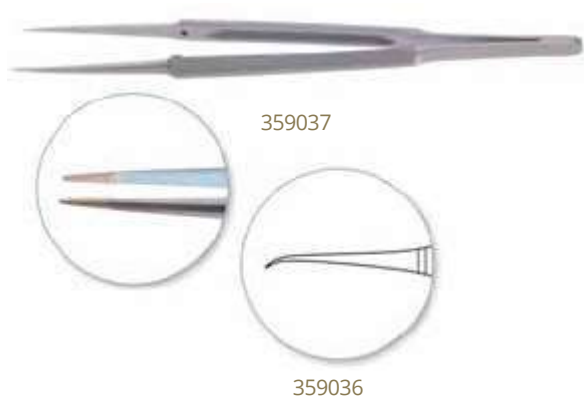

Round handle. Diama-Grip on tip.

Catalog #	Description
359033	Straight, 4-3/4" (12 cm)
359034	Curved, 3-3/4" (9.5 cm)
359037	Straight, 7-1/8" (18 cm)
359036	Curved, 5-7/8" (15 cm), 6 mm Diama-Grip jaws

MICRO TITANIUM DIAMA-GRIP TYING FORCEPS



Straight with round handle. Diama-Grip ring tip.

Catalog #	Description
359042	I.D. 0.4 mm, O.D. 1 mm, 7-1/8" (18 cm)
359283	I.D. 1 mm, O.D. 2 mm, 8-3/4" (22 cm)
359284	I.D. 0.4 mm, O.D. 1 mm, 8-3/4" (22 cm)

TITANIUM INSTRUMENTS FORCEPS AND CLAMPS

Hemostatic Forceps

CRILE TITANIUM HEMOSTATIC FORCEPS



Catalog #
359307

Description
Curved, serrated jaw, 5-5/8" (15 cm)

HALSTED TITANIUM HEMOSTATIC FORCEPS



Catalog #
359296
359299

Description
Curved, serrated jaws, 4-3/4" (12.5 cm) Delicate
curved, serrated jaws, 4-3/4" (12.5 cm)

TITANIUM INSTRUMENTS FORCEPS AND CLAMPS

Pediatric Vascular Clamps

CASTANEDA TITANIUM VASCULAR CLAMPING FORCEPS

Clamping Forceps (10 g).

Catalog #	Description
359201	Straight jaw, 5-1/8" (13 cm)
359206	Curved jaw, 4-3/4" (12 cm)
359208	Curved jaw, 6-1/2" (17 cm)



TITANIUM INSTRUMENTS FORCEPS AND CLAMPS

Pediatric Vascular Clamps

CASTANEDA TITANIUM VASCULAR CLAMPING FORCEPS



359213

Clamping Forceps (15 g).

Catalog #	Description
359209	Curved jaw, 6-1/2" (17 cm)
359210	Curved jaw, 6-3/8" (17 cm)
359211	Straight jaw, 6-5/8" (17 cm)
359212	30 degree angled jaw, 6-1/4" (16 cm)
359213	50 degree angled jaw, 6" (15 cm)
359214	70 degree angled jaw, 5-7/8" (15 cm)
359215	90 degree angled jaw, 5-3/8" (13.5 cm)



359209



359210



359211



359212



359214

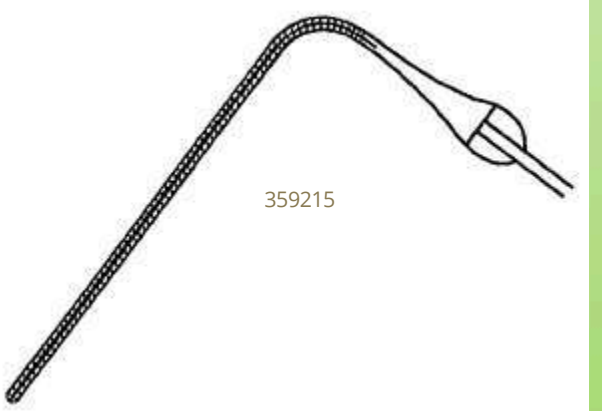

359215

TITANIUM INSTRUMENTS

FORCEPS AND CLAMPS

Pediatric Vascular Clamps

COOLEY TITANIUM PEDIATRIC CLAMP



Catalog #
359221

Description
Spoon-shaped for coarctation, 7-1/4" (18.5 cm)

DEBAKEY® TITANIUM PEDIATRIC CLAMPS



Catalog #
359354
359355
359356
359357
359358

Description
Straight jaws, 4-3/8" (11 cm)
60 degree angled jaws, 4" (10.5 cm)
Anastomosis clamp with 9.5 mm angled operational jaw length, 3-7/8" (10 cm)
Anastomosis clamp with 6 mm curved operational jaw length, 3-7/8" (9.5 cm)
Anastomosis clamp with 16 mm operational jaw length, 4-1/8" (10.5 cm)



TITANIUM INSTRUMENTS

FORCEPS AND CLAMPS

Pediatric Vascular Clamps

DERRA TITANIUM ANASTOMOSIS CLAMPS



Catalog #
359236
359237

Description
Curved jaws, 6-11/16" (17 cm)
Curved jaws, 6-13/16" (17.5 cm)

Vascular Clamps

CRAFOORD TITANIUM CLAMPING FORCEPS



Catalog #
359325

Description
Curved, serrated jaws, 9-1/2" (24 cm)

TITANIUM INSTRUMENTS

FORCEPS AND CLAMPS

Vascular Clamps
DEBAKEY TITANIUM VASCULAR CLAMPS

®



359162

Catalog #	Description
359161	Aorta clamp, curved jaw, 11-1/8" (28.5 cm)
359162	Aorta clamp, curved jaw, 11-3/4" (30 cm)
359163	Aorta clamp, curved jaw, 12-5/8" (32 cm)
359185	Occlusion clamp with 50 mm operational jaw length, 10-3/4" (27 cm)
359186	Occlusion clamp with 40 mm operational jaw length, 10" (25 cm)
359187	Occlusion clamp with 30 mm operational jaw length, 10" (25 cm)
359188	Occlusion clamp with 25 mm operational jaw length, 9-1/2" (24 cm)

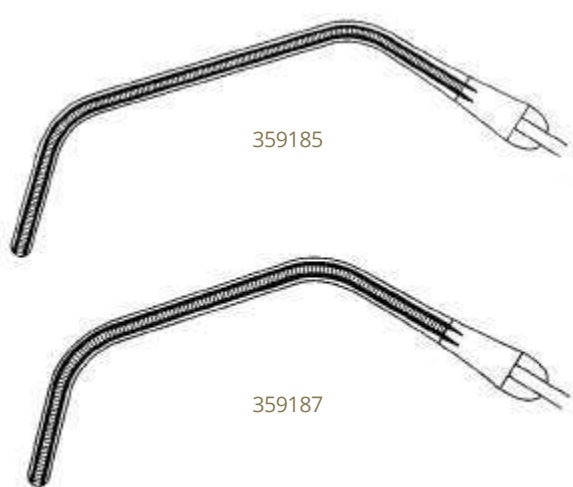

359185

359187

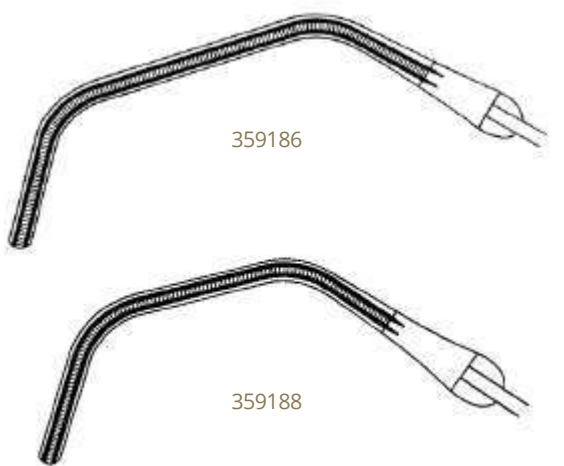

359186

359188

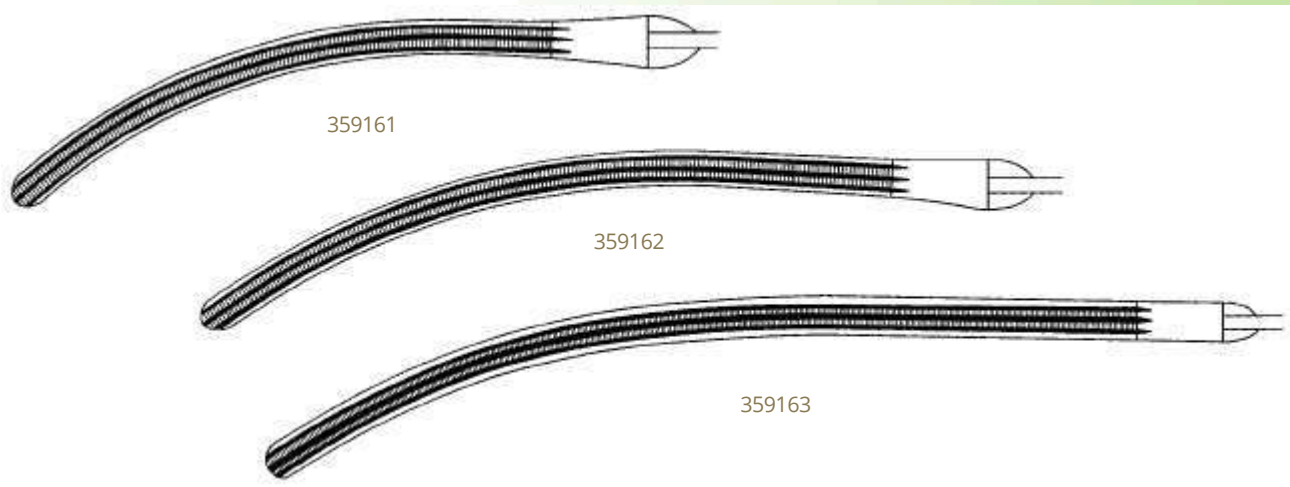

359161

359162

359163

TITANIUM INSTRUMENTS FORCEPS AND CLAMPS

Vascular Clamps

DEBAKEY® TITANIUM VASCULAR CLAMPS



Catalog #	Description
359159	70 degree angled jaw, 10-1/4" (26 cm)
359195	45 degree angled jaw, 10-1/2" (26.5 cm)
359181	60 degree angled jaw, 11-3/4" (30 cm)
359183	60 degree angled jaw, 9-3/8" (23.5 cm)
359184	60 degree angled jaw, 8-1/2" (21.5 cm)

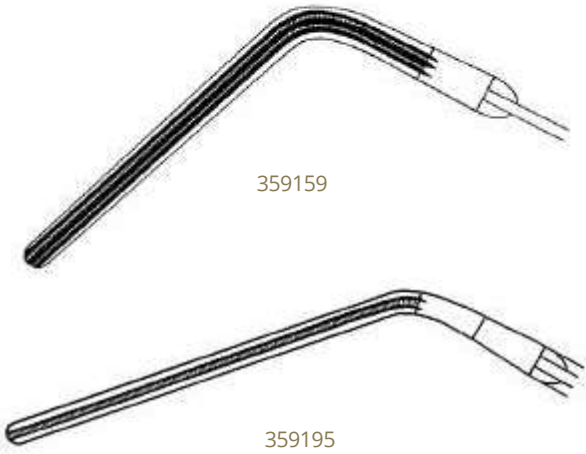

DEBAKEY® TITANIUM VASCULAR CLAMPS



Catalog #	Description
359173	Curved jaw, 7-7/8" (20 cm)

TITANIUM INSTRUMENTS

FORCEPS AND CLAMPS

Vascular Clamps

GLOVER TITANIUM AURICULAR CLAMP

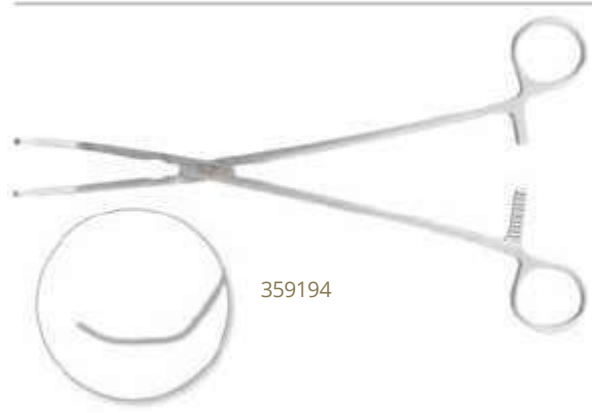

Catalog #
359194

Description
Auricular handles with 30 mm operational jaw length, 10" (25 cm)

GLOVER TITANIUM COARCTATION VASCULAR CLAMPS

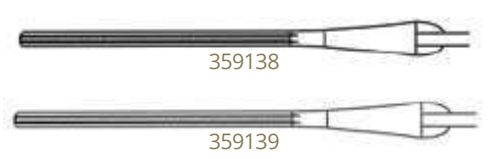

Catalog #
359138
359139

Description
Straight handles, DeBakey® Jaws, 8-5/8" (22 cm)
Angled handles, DeBakey® Jaws, 8-5/8" (22 cm)

HEISS TITANIUM CLAMPING FORCEPS



Catalog #
359314

Description
Angled handles, DeBakey® jaws, 8-5/8" (22 cm)

TITANIUM INSTRUMENTS FORCEPS AND CLAMPS

Vascular Clamps

HUFNAGEL TITANIUM VASCULAR CLAMP

Catalog #	Description
359160	Curved DeBakey® Jaw, 8-5/8" (22 cm)

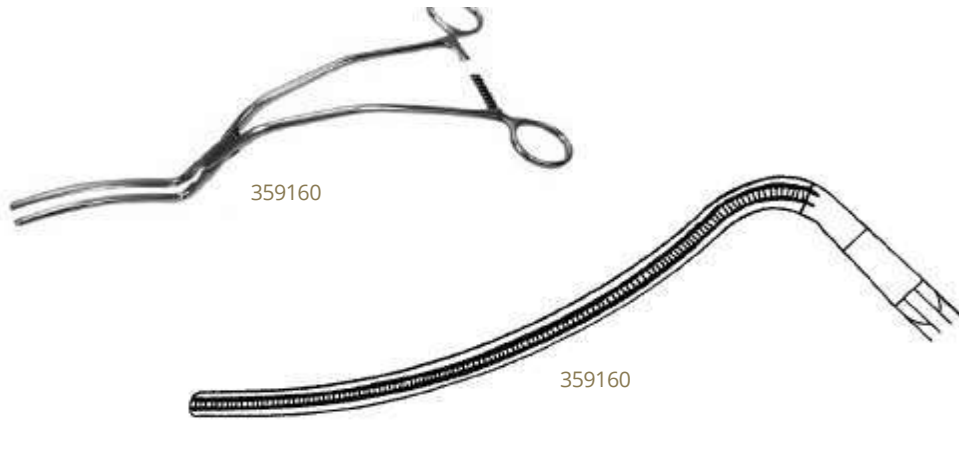

KAY TITANIUM VASCULAR CLAMP

Catalog #	Description
359152	Curved DeBakey® Jaws, 7-7/8" (20 cm)



TITANIUM INSTRUMENTS

FORCEPS AND CLAMPS

Vascular Clamps

LELAND-JONES TITANIUM VASCULAR CLAMPS



Catalog #
359169
359170
359171

Description
30 degree angled DeBakey® Jaws, 7-1/2" (19 cm)
15 degree angled DeBakey® Jaws, 7-7/8" (20 cm)
Straight, DeBakey® Jaw, 8-1/4" (21 cm)



O'SHAUGHNESSY TITANIUM CLAMPING FORCEPS

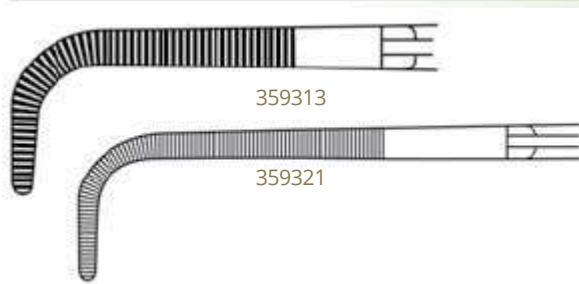

Catalog #
359313
359321

Description
Strong curve, serrated jaw, 8-1/4" (21 cm)
Strong curve, serrated jaw, 9-5/8" (24.5 cm)

TITANIUM INSTRUMENTS FORCEPS AND CLAMPS

Vascular Clamps

RENAL ARTERY TITANIUM VASCULAR CLAMP



359238

Catalog #
359238

Description
Curved jaws, 7-1/2" (19 cm)

SATINSKY TITANIUM VASCULAR CLAMPS



359191

359191

359193

Catalog #
359191
359193

Description
Vena cava clamp with 30 mm operational DeBaKey®
Jaw length, 9-5/8" (24.5 cm)
Vena cava clamp with 20 mm operational DeBaKey®
Jaw length, 9-1/2" (24 cm)

TITANIUM INSTRUMENTS FORCEPS AND CLAMPS

Bulldog® Clamps

DEBAKEY® TITANIUM BULLDOG® CLAMPS



Catalog #	Description
359122	Straight, 3" (7.5 cm)
359123	Straight, 3-3/8" (8.5 cm)
359124	Straight, 3-7/8" (10 cm)
359127	Curved, 3-1/4" (8.5 cm)
359128	Curved, 3-7/8" (10 cm)
359131	Angled 45 degrees, 4-3/4" (12 cm)

TITANIUM INSTRUMENTS

SCISSORS

Micro Scissors

MICRO TITANIUM SCISSORS



359006

With flat handle.

Catalog #	Description
359003	Curved, 6-1/4" (16 cm)
359006	Straight, delicate, 6-1/4" (16 cm)
359250	Curved, serrated, 8-1/4" (21 cm)
359253	Straight, 9" (23 cm)



359003



359006



359250



359253

TITANIUM INSTRUMENTS

SCISSORS

Potts-Style Scissors

POTTS MICRO TITANIUM SCISSORS



With flat handle, 16 mm blades.

Catalog #	Description
359016	Angled 25 degrees, 7-1/4" (18.5 cm)
359017	Angled 45 degrees, 7-1/4" (18.5 cm)
359018	Angled 60 degrees, 7-1/4" (18.5 cm)
359019	Angled 90 degrees, 6-3/4" (17.0 cm)
359020	Angled 130 degrees, 6-3/4" (17.0 cm)



TITANIUM INSTRUMENTS

NEEDLE HOLDERS

Round Handle Micro Needle Holders

JACOBSON MICRO TITANIUM NEEDLE HOLDERS



Straight, round handle with lock. Diama-Grip jaws.

Catalog #	Description
359402	Heavyweight, 2 mm jaw, 9" (23 cm)
359401	12 x 1 mm jaw, 9" (23 cm)
359403	16 mm jaw, 8-1/4" (21 cm)

JACOBSON TITANIUM CASTROVIEJO NEEDLE HOLDERS



Round handle with lock. Diama-Grip jaws.

Catalog #	Description
359071	Straight, 1.8 mm jaw, 8-1/4" (21 cm)
359343	Curved, 1.1 mm jaw, 9" (23 cm)

MICRO TITANIUM CASTROVIEJO NEEDLE HOLDERS

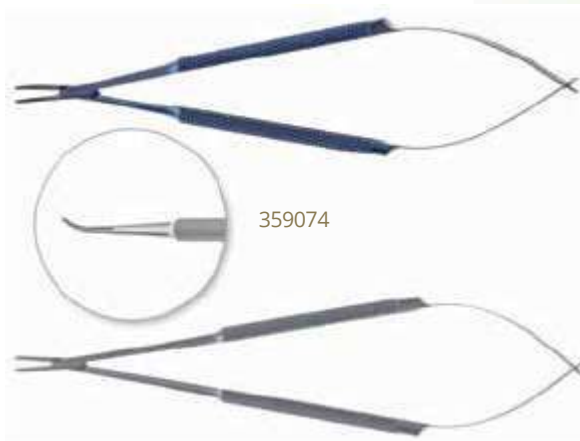

Round handle, Diama-Grip jaws.

Catalog #	Description
359069	Straight, with lock, 1 mm jaw, 7-1/8" (18 cm)
359073	Straight, 1 mm jaw, 6-1/4" (16 cm)
359074	Curved, 1 mm jaw, 6-1/4" (16 cm)
359075	Straight, 1 mm jaw, 7-1/8" (18 cm)
359340	Straight, 1.1 mm jaw, 9" (23 cm)
359342	Curved, 1.1 mm jaw, 9" (23 cm)

359075

TITANIUM INSTRUMENTS

NEEDLE HOLDERS

Round Handle Micro Needle Holders

MICRO TITANIUM CASTROVIEJO NEEDLE HOLDERS



Straight, round handle, serrated jaws.

Catalog #	Description
359344	1 mm jaw, 6-1/4" (16 cm), TC
359345	With lock, 1 mm jaw, 6" (16 cm), TC
359346	7-1/8" (18 cm), TC
359347	With lock, 8.8 x 1.3 mm jaw, 7-1/8" (18 cm), TC
359349	1.5 mm jaw, 8-1/4" (21 cm), TC
359350	With lock, 1.4 mm jaw, 8-1/4" (21 cm), TC
359352	With lock, 1.5 mm jaw, 9" (23 cm), TC

Flat Handle Micro Needle Holders

MICRO TITANIUM CASTROVIEJO NEEDLE HOLDERS

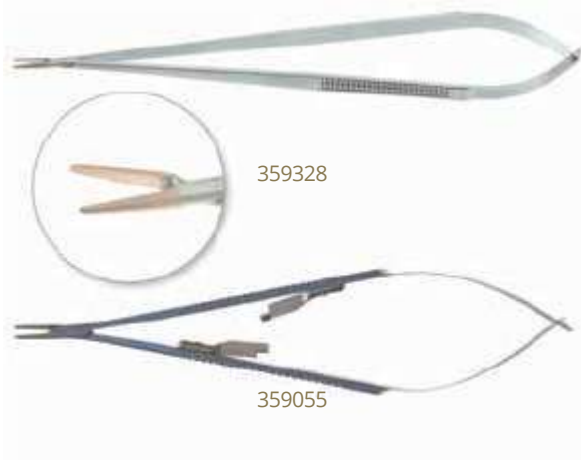

Diama-Grip jaws with flat handle.

Catalog #	Description
359061	Straight, 9 x 1 mm jaw, 6-1/4" (16 cm)
359063	Straight, 9 x 1 mm jaw, 7-1/8" (18 cm)
359328	Straight, 9 x 1 mm jaw, 9" (23 cm)
359062	Curved, 8 x 1 mm jaw, 6-1/4" (16 cm)
359059	Straight with lock, 9 x 1 mm jaw, 8-1/4" (21 cm)
359329	Straight with lock, 9 x 1 mm jaw, 9" (23 cm)
359055	Straight with lock, 9 x 1 mm jaw, 6-1/4" (16 cm)
359058	Curved with lock, 8 x 1 mm jaw, 7-1/8" (18 cm)

MICRO TITANIUM CASTROVIEJO NEEDLE HOLDERS TC



Straight, serrated with flat handle and lock.

Catalog #	Description
359335	Straight with lock, 9 x 1 mm jaw, 7-1/8" (18 cm), TC
359339	Straight with lock, 8 x 1.4 mm jaw, 9" (23 cm), TC

TITANIUM INSTRUMENTS

NEEDLE HOLDERS

Ring Handle Needle Holders
DEBAKEY® TITANIUM NEEDLE HOLDER

®

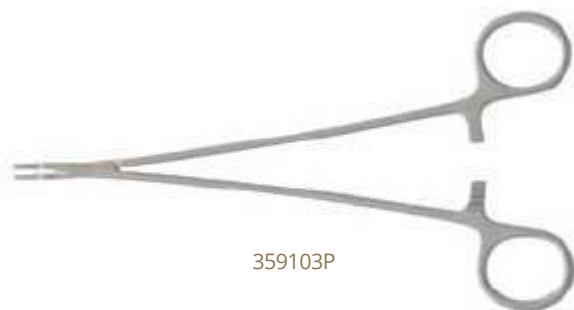

359103P

Catalog #	Description
359103P	1.5 mm Diama-Grip jaw, 8" (20 cm)

DEBAKEY® TITANIUM RING HANDLE NEEDLE HOLDERS



359099

4000 teeth per square inch.

Catalog #	Description
359381	1.5 mm jaw, 6-1/4" (16 cm), TC
359099	16 x 1.4 mm jaw, 8" (20.5 cm), TC

DEBAKEY® TITANIUM RING HANDLE NEEDLE HOLDERS

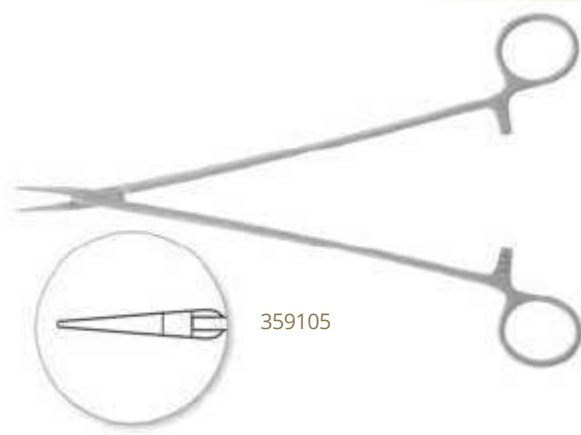

359105

Diama-Grip jaws.

Catalog #	Description
359102	1.6 mm jaw, 7" (18.5 cm)
359104	1.5 mm jaw, 8-5/8" (22 cm)
359105	1.6 mm jaw, 10" (25.5 cm)

TITANIUM INSTRUMENTS

NEEDLE HOLDERS

Ring Handle Needle Holders

DERF TITANIUM RING HANDLE NEEDLE HOLDER



4000 teeth per square inch.

Catalog #	Description
359083	1.6 mm jaw, 4-1/2" (11.5 cm), TC

HALSEY TITANIUM RING HANDLE NEEDLE HOLDER



For suture sizes 4-0 to 6-0, 4000 teeth per square inch.

Catalog #	Description
359085	15 x 1.5 mm jaw, 5" (12.5 cm), TC

TITANIUM INSTRUMENTS

NEEDLE HOLDERS

Ring Handle Needle Holders

INTRACARDIAC TITANIUM RING HANDLE NEEDLE HOLDER



Catalog #	Description
359113P	1.8 mm jaw, 10" (25 cm), Diamo-Grip

INTRACARDIAC TITANIUM RING HANDLE NEEDLE HOLDERS

Diamo-Grip jaws.



Catalog #	Description
359110	21 x 2 mm jaw, 7" (18.5 cm)
359111	24 x 2 mm jaw, 8" (20.5 cm)
359112	24 x 2 mm jaw, 8-5/8" (22 cm)

MAYO HEGAR TITANIUM RING HANDLE NEEDLE HOLDERS

1800 teeth per square inch.



Catalog #	Description
359080	16 x 1.8 mm jaw, 7-1/8" (18 cm), TC
359082	16 x 1.8 mm jaw, 8-3/4" (22 cm), TC

TITANIUM INSTRUMENTS

NEEDLE HOLDERS

Ring Handle Needle Holders

MICROVASCULAR TITANIUM RING HANDLE NEEDLE HOLDERS



Diama-Grip jaws.

Catalog #	Description
359382	1.8 mm jaw, 6" (16 cm)
359118	1.8 mm jaw, 7-1/4" (18.5 cm)
359119	1.8 mm jaw, 8" (20.5 cm)

RYDER TITANIUM RING HANDLE NEEDLE HOLDERS



Diama-Grip jaws.

Catalog #	Description
359092	10 x 1.4 mm jaw, 6" (16 cm)
359093	10 x 1.4 mm jaw, 6-3/4" (17 cm)

RYDER TITANIUM RING HANDLE NEEDLE HOLDERS



7000 teeth per square inch.

Catalog #	Description
359097	8 x 1.6 mm jaw, 8" (19.5 cm), TC

TITANIUM INSTRUMENTS

Retractors

FINOCHIETTO TITANIUM STERNAL RETRACTOR



359383

Catalog #
359383

Description
Arm length 52 mm

PEDIATRIC TITANIUM STERNAL SPREADER



359353

Catalog #
359353

Description
2 pairs of blades, spread 2" (5 cm),
arm length 52 mm

CURETTES

CURETTES

Brun Currettes

BRUN (SPRATT) CURETTES

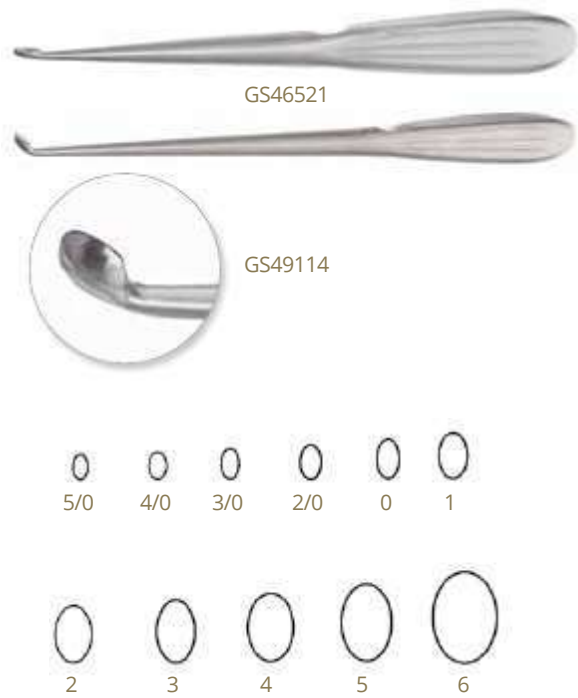

Oval cup, hollow handle.

Catalog #	tip shape	size	length
GS46511	Straight	#5/0	7" (18 cm)
GS46512	Straight	#4/0	7" (18 cm)
GS46513	Straight	#3/0	7" (18 cm)
GS46515	Straight	#2/0	7" (18 cm)
GS46517	Straight	#0	7" (18 cm)
GS46519	Straight	#1	7" (18 cm)
GS46521	Straight	#2	7" (18 cm)
GS46523	Straight	#3	7" (18 cm)
GS46525	Straight	#4	7" (18 cm)
GS46529	Straight	#5	7" (18 cm)
GS46531	Straight	#6	7" (18 cm)
GS46563	Straight	#3/0	9" (23 cm)
GS46564	Straight	#2/0	9" (23 cm)
GS46565	Straight	#0	9" (23 cm)
GS46566	Straight	#1	9" (23 cm)
GS46567	Straight	#2	9" (23 cm)
GS46568	Straight	#3	9" (23 cm)
GS46569	Straight	#4	9" (23 cm)
GS46570	Straight	#5	9" (23 cm)
GS46571	Straight	#6	9" (23 cm)
GS49110	Angled 45 degrees	#3/0	9" (23 cm)
GS49111	Angled 45 degrees	#2/0	9" (23 cm)
GS49112	Angled 45 degrees	#0	9" (23 cm)
GS49113	Angled 45 degrees	#1	9" (23 cm)
GS49114	Angled 45 degrees	#2	9" (23 cm)
GS49115	Angled 45 degrees	#3	9" (23 cm)
GS49116	Angled 45 degrees	#4	9" (23 cm)
GS49117	Angled 45 degrees	#5	9" (23 cm)
GS49118	Angled 45 degrees	#6	9" (23 cm)

CURETTES

Brun Currettes

ORTHOPEDIC INSTRUMENTS

BRUN (SPRATT) CURETTES

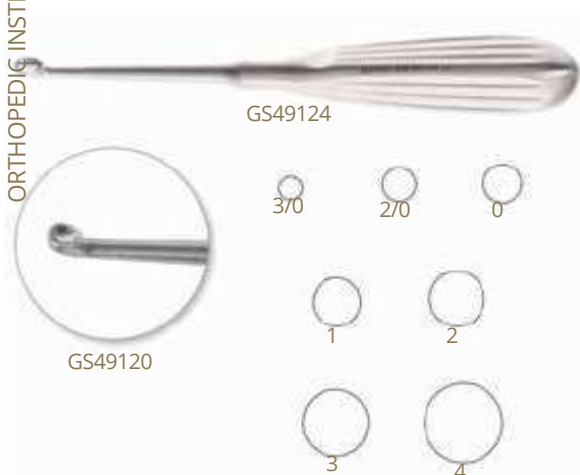

Round up, hollow handle.

Catalog #	tip shape	size	length
GS49120	Straight	#3/0	6-3/4" (17 cm)
GS49121	Straight	#2/0	6-3/4" (17 cm)
GS49122	Straight	#0	6-3/4" (17 cm)
GS49123	Straight	#1	6-3/4" (17 cm)
GS49124	Straight	#2	6-3/4" (17 cm)
GS49125	Straight	#3	6-3/4" (17 cm)
GS49126	Straight	#4	6-3/4" (17 cm)

CURETTES

Brun Currettes

BRUN CURETTES



Pattern, 8-7/8" (22.5 cm).

Catalog #	Description
343500	Size 000
343501	Size 00
343502	Size 0
343503	Size 1
343504	Size 2
343505	Size 3
343506	Size 4

BRUN CURETTES



Solid hexagonal handle, 9" (23 cm).

Catalog #	tip shape	size
GS46551	Straight	#3/0
GS46552	Straight	#2/0
GS46553	Straight	#0
GS46554	Straight	#1
GS46555	Straight	#2
GS46556	Straight	#3
GS46557	Straight	#4
GS46558	Straight	#5
GS46559	Straight	#6
GS49150	Angled 45 degrees	#3/0
GS49151	Angled 45 degrees	#2/0
GS49152	Angled 45 degrees	#0
GS49153	Angled 45 degrees	#1
GS49154	Angled 45 degrees	#2
GS49155	Angled 45 degrees	#3
GS49156	Angled 45 degrees	#4
GS49157	Angled 45 degrees	#5
GS49158	Angled 45 degrees	#6

CURETTES

Cobb Currettes

ORTHOPEDIC INSTRUMENTS

COBB CURETTES, ALUMINUM HANDLE



All stainless steel working end and anodized aluminum, knurled handle, 11" (28 cm).

Catalog #	tip shape	size
GS46422	Straight	#3/0
GS46423	Straight	#2/0
GS46424	Straight	#0
GS46425	Straight	#1
GS46426	Straight	#2
GS46427	Straight	#3
GS46428	Straight	#4
GS46429	Straight	#5
GS46430	Straight	#6
GS46433	Angled	#3/0
GS46434	Angled	#2/0
GS46435	Angled	#0
GS46436	Angled	#1
GS46437	Angled	#2
GS46438	Angled	#3
GS46439	Angled	#4
GS46440	Angled	#5
GS46441	Angled	#6

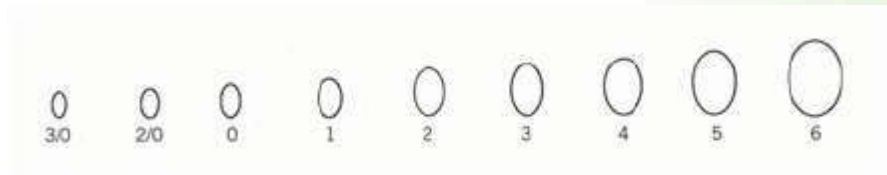

CURETTES

Cobb Currettes

COBB CURETTES, STAINLESS STEEL HANDLE



All stainless steel working end and stainless steel, knurled handle, 11" (28 cm).

Catalog #	tip shape	size
GS46422S	Straight	#3/0
GS46423S	Straight	#2/0
GS46424S	Straight	#0
GS46425S	Straight	#1
GS46426S	Straight	#2
GS46427S	Straight	#3
GS46428S	Straight	#4
GS46429S	Straight	#5
GS46430S	Straight	#6
GS46433S	Angled	#3/0
GS46434S	Angled	#2/0
GS46435S	Angled	#0
GS46436S	Angled	#1
GS46437S	Angled	#2
GS46438S	Angled	#3
GS46439S	Angled	#4
GS46440S	Angled	#5
GS46441S	Angled	#6

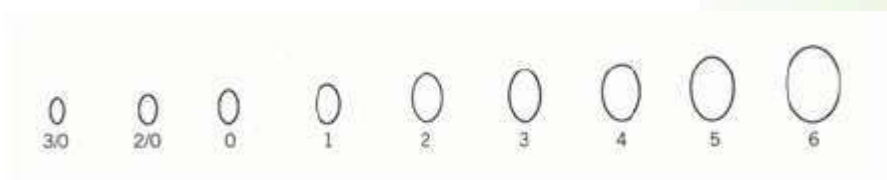

CURETTES

Specialty Bone Curettes

ORTHOPEDIC INSTRUMENTS

HEMPSTEIN CURETTES



GS49584

Reverse angle, hollow handle, 8" (20.5 cm).

Catalog #	Description
GS49580	#000
GS49582	#00
GS49584	#0



SCOVILLE CURETTES



GS49574

Catalog #	Description
GS49574	Straight, 10" (25.5 cm)
GS49576	Down angle, 10" (25.5 cm)
GS49578	Up angle, 10" (25.5 cm)



GS49576



GS49578

CURETTES

Specialty Bone Curettes

HATFIELD BONE CURETTES



Stainless steel with satin finish. Oval shaped tips, overall length 9" (23 cm). Complete set of nine curettes.

Catalog #	size	tip Width	tip length
584160	000	2.5 mm	4.0 mm
	00	2.8 mm	4.6 mm
	0	3.3 mm	5.0 mm
	1	3.8 mm	6.0 mm
	2	4.8 mm	7.6 mm
	3	5.8 mm	9.2 mm
	4	7.2 mm	11.6mm
	5	8.7 mm	12.8mm
	6	10.5 mm	15.5mm

JANSEN CURETTE



Catalog #	Description
GS29632	Double-ended, oval cups, 6" (15 cm)

CURETTES

Specialty Bone Curettes

ORTHOPEDIC INSTRUMENTS

MARTINI BONE CURETTE



GS29620

Catalog #
GS29620

Description
Double-ended, 4 mm and 5 mm round cups,
5-1/2" (14 cm)

WILLIGER BONE CURETTE



GS29630

Catalog #
GS29630

Description
Double-ended, 3 mm and 4 mm oval cups,
5-1/2" (14 cm)

VOLGSANN CURETTES



GS49202

Double-ended, oval cups.

Catalog #
GS49200
GS49202
GS46550
GS49204

Description
Double-ended, straight, 5" (12.5 cm)
Double-ended, straight, 5 1/2" (14 cm)
Double-ended, oval cups, 6 1/2" (16.5 cm)
Double-ended, straight, 8" (20.5 cm)



GS49200



GS49202



GS46550



GS49204



CURET TES

Specialty Bone Curettes

VOLGSANN CURETTES



Double-ended, oval and round cups.

Catalog #	Description
GS46560	5" (12.5 cm) 8"
GS46561	(20.5 cm) 6-1/2"
GS46562	(16.5 cm)

CONE RING CURETTES



Knurled handle and fenestrated cup, 9" (23 cm).

Catalog #	tip shape	size	tip
GS49450	Straight	#1	8mm diameter
GS49452	Straight	#2	6mm diameter
GS49454	Straight	#3	3mm diameter
GS49456	Angled 35 degrees	#1	8mm diameter
GS49458	Angled 35 degrees	#2	6mm diameter
GS49460	Angled 35 degrees	#3	3mm diameter

CURETTES

Specialty Bone Curettes

ORTHOPEDIC INSTRUMENTS

DRILLING CURETTES



GS55685

GS55682
GS55686
GS55682
GS55686

Hollow handle with fenestrated cup.

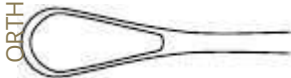

GS55681
GS55685

GS55681
GS55685
GS55681
GS55685

SR 55680 CU, Old

Catalog #
GS55680
GS55684
GS55681
GS55685

Description
Size 0, small, 10" (25.5 cm)
Size 0, small, 11-1/2" (29 cm)
Size 2, medium, 10" (25.5 cm)
Size 2, medium, 11-1/2" (29 cm)

SR 55680 CU, Old

GS55682
GS55686

Size 6, large, 10-1/4" (26 cm)
Size 6, large, 12" (30.5 cm)

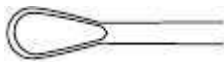

GS55680
GS55684

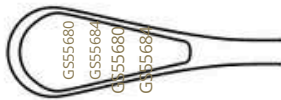

GS55682
GS55686

GS55682
GS55686

GS55681
GS55685

SR 55680 CU, Old

RAY PITUITARY CURETTES



GS49405

GS55680
GS55684
7-1/2" (19 cm).



GS49424

Catalog #
GS49403
GS49404
GS49405
GS49413
GS49414
GS49415
GS49423
GS49424
GS49425
GS49433
GS49434
GS49435

tip shape	tip
Vertical angle 45 degrees	3mm
Vertical angle 45 degrees	4mm
Vertical angle 45 degrees	5mm
Vertical angle 90 degrees	3mm
Vertical angle 90 degrees	4mm
Vertical angle 90 degrees	5mm
Horizontal angle 45 degrees	3mm
Horizontal angle 45 degrees	4mm
Horizontal angle 45 degrees	5mm
Horizontal angle 90 degrees	3mm
Horizontal angle 90 degrees	4mm
Horizontal angle 90 degrees	5mm



GS49403



GS49413

3mm

4mm

5mm



GS49423



GS49433

CURET TES

Endoscopic Curettes

ENDO BRUN CURETTES

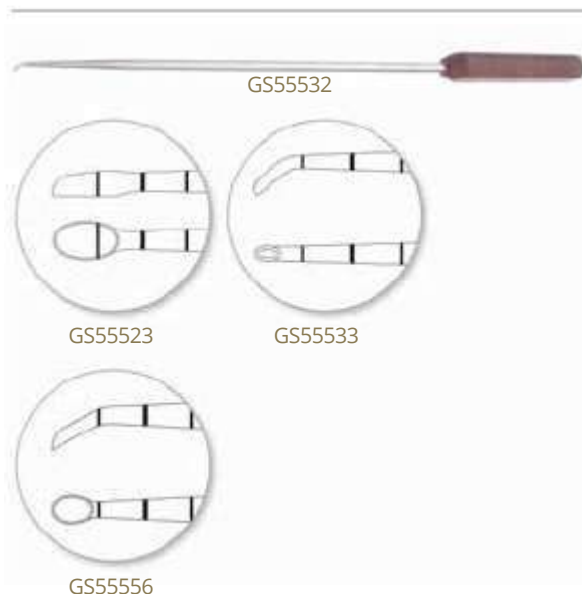

Endoscopic with phenolic handle.

Catalog #	tip shape	tip	tip length	shaft length	shaft Dia.	hanDle length	overall length
GS55532	Angled 40°	2x4mm cup	2.7	9.3"	0.285"	5"	17" (43 cm)
GS55523	Straight	3x6mm cup	2.7	9.3"	0.285"	5"	17" (43 cm)
GS55533	Angled 40°	3x6mm cup	2.7	9.3"	0.285"	5"	17" (43 cm)
GS55543	Angled 40°	3x6mm cup	3-1/2"	10"	0.45"	6-1/2"	20" (51 cm)
GS55556	Angled 30°	6x9mm cup	3-1/2"	10"	0.45"	6-1/2"	20" (51 cm)

CURETTES

Endoscopic Curettes

ORTHOPEDIC INSTRUMENTS

ENDOCONERINGCURETTES



Endoscopic with phenolic handle.

Catalog#	tipshape	tip	tip length	shaft length	shaft Dia.	shaft length	handle length	overall length
GS55573	Angled 40°	3mm	2.7"	9.3"	0.285"	5"		17" (43cm)
GS55566	Angled 30°	6mm	3-1/2"	10"	0.45"	6-1/2"		20" (51 cm)

ENDOEPSTEINCURETTES

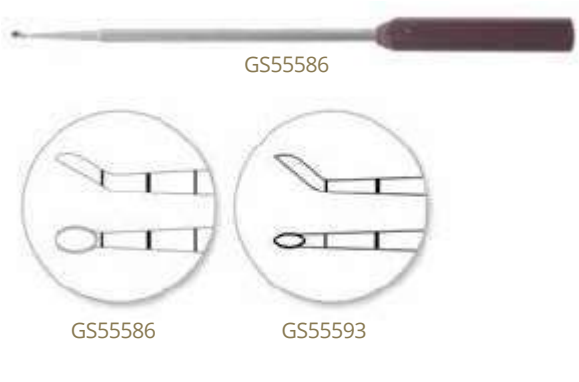

Catalog#	tipshape	tip	tip length	shaft length	shaft Dia.	shaft length	handle length	overall length
GS55593	Reverse-angled 40°	3x6mm	2.7"	9.3"	0.285"	5"		17" (43cm)
GS55586	Reverse-angled 30°	6x9mm	3-1/2"	10"	0.45"	6-1/2"		20" (51cm)

ENDO SCOVILLE CURETTE



Endoscopic with phenolic handle.

Catalog#	tipshape	tip	tip length	shaft length	shaft Dia.	shaft length	handle length	overall length
GS55510	Straight	9x15mm	3-1/2"	10"	0.45"	6-1/2"		20" (51cm)

LAPAROSCOPIC INSTRUMENTS

LAPAROSCOPIC INSTRUMENTS

Handle Types

INLINE RATCHETED HANDLE



INSULATED NON-ROTATING HANDLE



INSULATED ROTATING HANDLE



NON-INSULATED NON-ROTATING HANDLE



NON-INSULATED ROTATING HANDLE



RATCHETED NON-ROTATING HANDLE



RATCHETED ROTATING HANDLE



RONGEUR, ERGO GRIP HANDLE



SLIDE-LOCK HANDLE



SPRING-LOADED NON-ROTATING HANDLE



SQUEEZE HANDLE



U-HANDLE



728200 Flush Port Replacement Cap. Fits all handles.

LAPAROSCOPIC INSTRUMENTS

5 MM Dissectors, Grasping Forceps

CLAW GRASPER



728077

Spring-Loaded, Non-Rotating Handle.

Catalog #	Description
728077	2x3 teeth, 5 mm, 35 cm
728096	2x3 teeth, 10 mm, 35 cm

MARYLAND DISSECTORS



728014

Insulated Handle.

Catalog #	Description
728012	Non-Rotating, Monopolar, 5 mm, 35 cm
728013	Non-Rotating, Monopolar, 5 mm, 45 cm
728014	Rotating, Monopolar, 5 mm, 35 cm
728015	Rotating, Monopolar, 5 mm, 45 cm
728081	Non-Rotating, Monopolar, 10 mm, 35 cm

TAPERED MARYLAND DISSECTORS



728016

Insulated, Rotating Handle.

Catalog #	Description
728016	Monopolar, 5 mm, 35 cm

MIXTER DISSECTOR



728017

Insulated, Rotating Handle.

Catalog #	Description
728017	Monopolar, 5 mm, 35 cm

LAPAROSCOPIC INSTRUMENTS

5 MM Dissectors, Grasping Forceps

TAPERED (DOLPHIN NOSE) DISSECTION FORCEPS



728021

Insulated Handle.

Catalog #	Description
728020	Non-Rotating, Monopolar, 5 mm, 35 cm
728021	Rotating, Monopolar, 5 mm, 35 cm
728022	Rotating, Monopolar, 5 mm, 45 cm

BULLET NOSE DISSECTOR



728023

Insulated, Rotating Handle.

Catalog #	Description
728023	Monopolar, 5 mm, 35 cm

BLUNT NOSE GRASPER



728026

Insulated Handle.

Catalog #	Description
728024	Non-Rotating, Monopolar, 5 mm, 35 cm
728025	Non-Rotating, Monopolar, 5 mm, 45 cm
728026	Rotating, Monopolar, 5 mm, 35 cm
728027	Rotating, Monopolar, 5 mm, 45 cm

MICRO DISSECTORS



728029

Insulated Handle.

Catalog #	Description
728028	Non-Rotating, Monopolar, 5 mm, 35 cm
728029	Rotating, Monopolar, 5 mm, 35 cm

LAPAROSCOPIC INSTRUMENTS

5 MM Dissectors, Grasping Forceps

STRONGGRASPINGFORCEPS



728030

Insulated, Non-Rotating Handle.

Catalog#	Description
728030	Monopolar, 5 mm, 35 cm
728031	Monopolar, 5 mm, 45 cm

BOWELGRASPER-HUNTER



728032

Non-Insulated, Rotating Handle.

Catalog#	Description
728032	5mm,35cm
728033	5mm,45cm

LAPAROSCOPIC INSTRUMENTS

10 MM Dissectors

MARYLAND DISSECTORS



728082

Insulated, Rotating Handle.

Catalog#	Description
728082	Monopolar, 10 mm, 35 cm

MIXTER DISSECTORS



728091

Catalog#	Description
728090	Insulated, Rotating Handle, Monopolar, 10 mm, 35 cm
728091	Rongeur Ergo Grip Handle, Monopolar, 10 mm, 35 cm

LAPAROSCOPIC INSTRUMENTS

5-10 MM Biopsy Forceps

BIOPSY GRASPERS



728079

Spring-Loaded, Non-Rotating Handle.

Catalog #	Description
728079	1 x 1 teeth, 5 mm, 35 cm
728080	1 x 1 teeth, 5 mm, 45 cm

SPOON GRASPER



728097

Spring-Loaded, Non-Rotating Handle.

Catalog #	Description
728097	10 mm, 35 cm

BIOPSY FORCEPS



728034

Insulated, Non-Rotating Handle.

Catalog #	Description
728034	Oval, Monopolar, 5 mm, 35 cm
728035	Oval, Monopolar, 5 mm, 45 cm

BIOPSY PUNCH FORCEPS



728036

Insulated, Non-Rotating Handle.

Catalog #	Description
728036	Single Tooth, Monopolar, 5 mm, 35 cm
728037	Single Tooth, Monopolar, 5 mm, 45 cm

LAPAROSCOPIC INSTRUMENTS

5-10 MM Biopsy Forceps

HOOK BIOPSY PUNCH



728038

Insulated, Non-Rotating Handle.

Catalog #	Description
728038	Monopolar, 5 mm, 35 cm
728039	Monopolar, 5 mm, 45 cm

BIOPSY PUNCH



728040

Insulated, Non-Rotating Handle.

Catalog #	Description
728040	Monopolar, 5 mm, 35 cm
728041	Monopolar, 5 mm, 45 cm

LAPAROSCOPIC INSTRUMENTS

5 MM Bipolar Forceps

MICRO TIP



728098

U-Handle.

Catalog #	Description
728098	5 mm, 35 cm
728099	5 mm, 45 cm

STANDARD TIP



728100

U-Handle.

Catalog #	Description
728100	5 mm, 32 cm
728101	5 mm, 45 cm

GRASPING



728102

U-Handle

Catalog #	Description
728102	5 mm, 32 cm
728103	5 mm, 45 cm

LAPAROSCOPIC INSTRUMENTS

5 MM Ratcheted Graspers

LONG GRASPERS, SINGLE-ACTION



P15128

Slide Lock Handle.

Catalog #	Description
P15128	Non-Rotating, 5 mm, 36 cm
P30186	Non-Rotating, 5 mm, 45 cm
P35235	Rotating, 5 mm, 36 cm

LONG GRASPERS, DOUBLE-ACTION



P29862

Slide Lock, Rotating Handle.

Catalog #	Description
P29862	5 mm, 36 cm

RETRACTION GRASPERS



P29863

Slide Lock Handle.

Catalog #	Description
P29863	Rotating, Double-Action, 5 mm, 36 cm
P29864	Non-Rotating, Single-Action, 5 mm, 36 cm
P35236	Rotating, Single-Action, 5 mm, 36 cm

RATCHETED GRASPERS



728043

Ratcheted Handle.

Catalog #	Description
728042	Non-Rotating, Blunt Nose, 5 mm, 35 cm
728043	Rotating, Blunt Nose, Insulated Shaft, 5 mm, 35 cm
728058	Rotating, Heavy-Aggressive, Tungsten Carbide, Monopolar, 5 mm, 35 cm

LAPAROSCOPIC INSTRUMENTS

5 MM Ratcheted Graspers

DUAL CUP GRASPERS



728046

Ratcheted Handle.

Catalog #	Description
728044	Non-Rotating, 5 mm, 35 cm
728045	Non-Rotating, 5 mm, 45 cm
728046	Rotating, 5 mm, 35 cm
728047	Rotating, 5 mm, 45 cm

GRABBER FENESTRATED FORCEPS



728054

Ratcheted, Rotating Handle.

Catalog #	Description
728054	5 mm, 37 cm
728057	Long Grasping, Fenestrated, Tungsten Carbide, 5 mm, 35 cm

LONG, DOUBLE-ACTION GRASPERS



728052

Ratcheted, Rotating Handle.

Catalog #	Description
728052	5 mm, 37 cm
728053	5 mm, 45 cm

LONG, SINGLE-ACTION GRASPERS



728050

Ratcheted, Rotating Handle.

Catalog #	Description
728050	5 mm, 37 cm
728051	5 mm, 45 cm

LAPAROSCOPIC INSTRUMENTS

5 MM RATCHETED GRASPERS

RETRACTION GRASPERS



728056

Ratcheted, Rotating Handle.

Catalog #	Description
728055	Single-Action, 5 mm, 37 cm
728056	Double-Action, 5 mm, 37 cm

SNAKE TOOTH GRASPERS



728059

Ratcheted Handle.

Catalog #	Description
728059	Non-Rotating, Double-Action, 5 mm, 35 cm
728060	Rotating, Double-Action, 5 mm, 35 cm

STRONG GRASPERS



728061

Ratcheted, Rotating Handle.

Catalog #	Description
728061	Atraumatic, Fenestrated, 5 mm, 35 cm

ALLIS GRASPERS



728064

Ratcheted Handle.

Catalog #	Description
728062	Non-Rotating, Insulated Shaft, 5 mm, 35 cm
728063	Non-Rotating, Insulated Shaft, 5 mm, 45 cm
728064	Rotating, Insulated Shaft, 5 mm, 35 cm

LAPAROSCOPIC INSTRUMENTS

5-10 MM Ratcheted Graspers

ATRAUMATIC ALLIS GRASPERS



728067

Ratcheted Handle.

Catalog #	Description
728065	Non-Rotating, Insulated Shaft, 5 mm, 35 cm
728066	Non-Rotating, Insulated Shaft, 5 mm, 45 cm
728067	Rotating, Insulated Shaft, 5 mm, 35 cm
728068	Rotating, Insulated Shaft, 5 mm, 37 cm

BABCOCK GRASPERS



728069

Ratcheted Handle.

Catalog #	Description
728069	Non-Rotating, 5 mm, 35 cm
728070	Non-Rotating, Insulated, 5 mm, 45 cm
728071	Rotating, 5 mm, 35 cm
728072	Rotating, 5 mm, 35 cm
728092	Non-Rotating, 10 mm, 37 cm
728093	Rotating, 10 mm, 37 cm

PADDLE BABCOCK GRASPERS



728073

Ratcheted, Rotating Handle.

Catalog #	Description
728073	5 mm, 37 cm
728094	10 mm, 37 cm

DEBAKEY GRASPERS



728075

Ratcheted Handle.

Catalog #	Description
728074	Non-Rotating, Insulated Shaft, 5 mm, 35 cm
728075	Rotating, Insulated Shaft, 5 mm, 35 cm
728076	Rotating, Insulated Shaft, 5 mm, 45 cm

LAPAROSCOPIC INSTRUMENTS

5 MM Ratcheted Graspers

TENACULUM GRASPERS



728078

Ratcheted, Non-Rotating Handle.

Catalog #	Description
728078	5 mm, 35 cm
728095	10 mm, 35 cm

LAPAROSCOPIC INSTRUMENTS

5 MM Needle Holders

TUNGSTEN CARBIDE



728105

Squeeze Handle.

Catalog #	Description
728104	Straight, 5 mm, 35 cm
728105	Curved, 5 mm, 35 cm
728106	Curved, 5 mm, 45 cm

TUNGSTEN CARBIDE, RATCHETED



728107

Inline Ratcheted Handle.

Catalog #	Description
728107	Curved Left, 5 mm, 35 cm
728108	Curved Right, 5 mm, 35 cm
728109	Straight, 5 mm, 35 cm

LAPAROSCOPIC INSTRUMENTS

5 MM Scissors

HOOK SCISSORS



728002

Insulated Handle.

Catalog #	Description
728000	Non-Rotating, Monopolar, 5 mm, 35 cm
728001	Non-Rotating, Monopolar, 5 mm, 45 cm
728002	Rotating, Monopolar, 5 mm, 35 cm
728003	Rotating, Monopolar, 5 mm, 45 cm

SUPERCUT SCISSORS, METZENBAUM



728008

Insulated Handle.

Catalog #	Description
728006	Non-Rotating, Double-Action, Monopolar, 5mm, 35cm
728007	Non-Rotating, Double-Action, Monopolar, 5mm, 45cm
728008	Rotating, Double-Action, Monopolar, 5 mm, 35 cm
728009	Rotating, Double-Action, Monopolar, 5 mm, 45 cm

MICRO SCISSORS



728011

Non-Insulated, Non-Rotating Handle.

Catalog #	Description
728010	Straight, 5 mm, 35 cm
728011	Curved Left, 5 mm, 35 cm

SUPERCUT SCISSORS, PERITONEAL



728004

Non-Insulated, Non-Rotating Handle.

Catalog #	Description
728004	Single-Action, 5 mm, 35 cm
728005	Single-Action, 5 mm, 45 cm

LAPAROSCOPIC INSTRUMENTS

Trays



720000

Catalog #
720000
720000M

Description
Ext. size: 9-7/8" W x 20-3/4" L (25 x 52.5 cm) with
silicone mat
Silicone mat for 720000



720001

Catalog #
720001
720001M

Description
For 45 cm laparoscopic instruments.
Ext. size: 26" L (66 cm), with silicone mat
Silicone mat for 720001

LAPAROSCOPIC INSTRUMENTS

Electrodes, Coagulators

ELECTRODE HANDLE



ELECTRODE



SUCTION COAGULATOR



IRRIGATION/SUCTION COAGULATOR



BLUNT NEEDLE

728161 33cm
728162 45cm



RIGHT ANGLE (L-HOOK)

728163 33cm
728164 45cm



J-HOOK

728165 33cm
728166 45cm



SPATULA

728167 33cm
728168 45cm



BLUNT NOSE

728169 33cm
728170 45cm

728171 33cm
728172 45cm

728173 33cm
728174 45cm

728175 33cm
728176 45cm

728177 33cm
728178 45cm

728179 33cm
728180 45cm

728181 33cm
728182 45cm

728183 33cm
728184 45cm

728185 33cm
728186 45cm

728187 33cm
728190 45cm

728191 33cm
728192 45cm

ELECTRODE TIPS

LAPAROSCOPIC INSTRUMENTS

Verres Needles, Cannulas, Probes, Knot Pushers, Telescopes

VERRES NEEDLES



Verres Needle

Reusable.

Catalog #	Description
140875	10cm
140877	12cm
140878	15cm
728113	18cm

Weck® Vista® Disposable.

Catalog #	Description
35120	14 Ga., 12 cm
35150	14 Ga., 15 cm

Irrigating/Aspirating Tubes.

Catalog #	Description
728114	15 Ga., 33 cm
728115	15 Ga., 45 cm
728116	19 Ga., 33 cm
728117	19 Ga., 45 cm
728118	22 Ga., 33 cm
728119	22 Ga., 45 cm

Modular Reusable.

Catalog #	Description
140879	Modular Verres body and obturator, 120 mm, 12 cm
140880	Modular Verres body and obturator, 150 mm, 15 cm
140881	Sterile disposable needle tip for 140879, 10/box
140882	Sterile disposable needle tip for 140880, 10/box

CANNULAS

Suction/Irrigation, Dual (Trumpet) Valve.

Catalog #	Description
728142	5 mm, 28 cm 5
728143	mm, 45 cm 5
728144	mm, 34 cm
728145	10 mm, 35 cm

Hasson.

Catalog #	Description
728152	10/11 mm
728155	Auto Valve, 10/11 mm
728156	Thoracic Cannula Threaded, 12 mm

Reducer Sleeves.

Catalog #	Description
728157	10/11 mm to 5 mm
728158	12 mm to 5 mm
728159	12 mm to 10 mm
728160	5mm to 3 mm

Caps.

Catalog #	Description
728153	White, 11 mm x 15 mm
728154	Blue, 8 mm x 18 mm

PROBES, KNOT PUSHERS

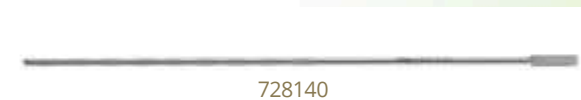

728140

Palpation Probes.

Catalog #	Description
728140	32cm
728141	45cm

Catalog #	Description
728195	Appel Type Knot Pusher, 5 mm, 40 cm, closed
728197	Appel Type Knot Pusher, 10 mm, 40 cm, closed
728199	Knot Pusher, 4 mm, 30 cm, open

LAPAROSCOPIC INSTRUMENTS

Verres Needles, Cannulas, Probes, Knot Pushers, Telescopes

TELESCOPES



728126

Fully Autoclavable.

Catalog #	Description
728120	5 mm, 30 cm, 0°
728121	5 mm, 30 cm, 30°
728122	5 mm, 30 cm, 45°
728125	10 mm, 33 cm, 0°
728126	10 mm, 33 cm, 30°
728130	10 mm, 33 cm, 45°
728131	10 mm, 45 cm, 0°
728132	10 mm, 45 cm, 30°
728133	10 mm, 45 cm, 45°
728134	Pediatric, 2.7 mm, 18 cm, 0°
728135	Pediatric, 2.7 mm, 18 cm, 30°

Retractors

FIVE FINGER FAN



728149

Catalog #	Description
728148	Rigid, 10 mm
728149	Articulating, 10 mm
P35776	Articulating, 5 mm

THREE FINGER FAN



728147

With flush port.

Catalog #	Description
728147	Rigid, 5 mm

LAPAROSCOPIC INSTRUMENTS

Retractors

LAZY "S"



728146

Catalog#
728146Description
10 mm wide, 7-1/4" (18 cm) long, Set of two

HASSON "S"



728150

Catalog#
728150
728151
306010ADescription
10 mm wide, 7-1/4" (18 cm) long, Set of two
13 mm wide, 7-1/4" (18 cm) long, Set of two
15 mm wide, 6-1/2" (16.5 cm) long, Set of two

O'REILLY ESOPHAGEAL



381801A

Catalog#
381801ADescription
9 mm wide, 54 cm

CORDS AND CABLES



602101B

Catalog#
602101B
602102B
601001A
601002ADescription
Bipolar Cord, 2-prong style (Valley Lab)
Bipolar Cord, 1-prong style (Wolf)
Monopolar Bovie High Frequency Cable, 1/4" plug
Monopolar Banana High Frequency Cable, 1/4" plug

601001A

LARYNGOSCOPES & SUBGLOTTISCOPES

LARYNGOSCOPES



NEW!
Ossoff-. Video
Laryngoscope
522194
See pg. 411 for details.

. LARYNGOSCOPES

Offering one of the largest selections of laryngoscopes in the world today, . Scopes include designs by leading surgeons. All laryngoscopes have fiberoptic light carriers.

LARYNGOSCOPE AND LASER LARYNGOSCOPE PATIENT SIZE LISTING

NEONATE/INFANT LARYNGOSCOPES

521500	Holinger
521550	Jackson
522002	Holinger

CHILD/PEDIATRIC LARYNGOSCOPES

521450	Tucker Jackson
521820	Direct Tucker
522004	Anterior Jako III
522216	.-Dedo
522222	

CHILD/PEDIATRIC LASER LARYNGOSCOPES

522237	Ossoff-Karlan-Dedo
--------	--------------------

CHILD/PEDIATRIC SUBGLOTTISCOPE

522242	Healy Pediatric Subglottiscope
--------	--------------------------------

ADOLESCENT LARYNGOSCOPES

521455	TuckerSlide
521554	Jackson
522209	Jako-CherryTypelll
522224	Dedo

LASER LARYNGOSCOPES

522238	Ossoff-Karlan
522292	.Double-Action

ADULT LARYNGOSCOPES

521460	Tucker
521465	Tucker Jackson
521556	Jackson
521558	JacksonDirect
521824	Holinger
522010	Holinger
522012	Holinger
522040	Holinger
522030	Holinger
522032	Holinger
522045	Jako-MicroTypelll
522206	
522225P	.-Dedo
522229	Abramson-Dedo

LASER LARYNGOSCOPES

522290	.-Dedo
522291	.-Ossoff
522193	.-OssoffVideo
522228	DedoMicro
522243	DedoExtraLong
522231	Ossoff-Karlan-Dedo
522232	Ossoff-Karlan-Jako
522233	Ossoff-Karlan
522229	Abramson-Dedo

SUBGLOTTISCOPE

522244	Ossoff
522245	Ossoff

LARYNGOSCOPES

TeethGuards

TEETH GUARDS



These nylon teeth guards were designed as protection for the patient's teeth against pressure that may be exerted during insertion and positioning of a laryngoscope.

Catalog #	Description
502275	Adult size teeth guards, box of 24 pair
502276	Adult size teeth guards, box of 3 pair

Laryngoscopes/Monocular View

TUCKER MID-LIGHTED SIDE SLIDE LARYNGOSCOPES



A standard Jackson Slide Laryngoscope with a mid-line fiber optic light carrier and Tucker modification of a side slide. The side slide removal allows for easy introduction of the bronchoscope. The shortened light carrier facilitates the use of the instrument in the vallecula to minimize the shadow cast by the epiglottis when introducing a bronchoscope. Supplied with one light carrier. Cable sold separately (pg. 467).

Catalog #	sCope size	overall length	Min i.D.	noMinal proximal i.D.	Max o.D.	replaCe Carrier
521450	Child	91mm	6.9mm	9.0mm	14.0mm	526510
521455	Adolescent	106mm	9.0mm	10.0mm	17.0mm	526512
521460	Adult	121mm	10.7mm	12.0mm	19.0mm	526515
521465	Long Adult	160mm	11.8mm	12.0mm	19.0mm	526516



Drawings illustrate Nominal Proximal Internal Dimensions and Minimum Internal Diameter (I.D.), NOT TO SCALE.

LARYNGOSCOPES

Laryngoscopes/Monocular View

HOLINGER INFANT (NEWBORN) SLIDE LARYNGOSCOPE



521500

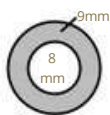

521500

Drawings illustrate Nominal Proximal Internal Dimensions and Minimum Internal Diameter (I.D.), NOT TO SCALE

Supplied with a very small light carrier to permit maximum lumen. Cable sold separately (pg. 467).

Catalog #	sCope size	overall length	Min i.D.	noMINAL proximal i.D	Max o.D.	replaCe Carrier
521500	Infant	82 mm	8.0 mm	9.0 mm	14.0 mm	526204

LARYNGOSCOPES

Laryngoscopes/Monocular View

JACKSON STANDARD FIBER OPTIC SLIDE LARYNGOSCOPES



521552



521554

The Jackson Standard Slide Laryngoscope is considered the standard scope and is used not only for introduction of a bronchoscope but also for operating in the larynx. Removable slide at bottom of scope. Supplied with one light carrier. Cable sold separately (pg. 467).

Catalog #	scope size	overall length	Min i.D.	nominal proximal i.D.	Max o.D.	replace Carrier
521550	Infant	95mm	8.0mm	10.0mm	16.0mm	526000
521552	Child	125mm	10.5mm	12.0mm	17.0mm	526006
521554	Adolescent	160mm	10.6mm	12.0mm	17.0mm	526018
521556	Adol/Adult	160mm	11.4mm	13.0mm	18.0mm	526018
521558	Adult	160mm	13.0mm	14.0mm	21.0mm	526018



Drawings illustrate Nominal Proximal Internal Dimensions and Minimum Internal Diameter (I.D.), NOT TO SCALE

LARYNGOSCOPES

Laryngoscopes/Monocular View

JACKSON DIRECT OR ANTERIOR COMMISSURE LARYNGOSCOPES



521820



521820

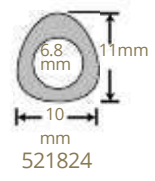

521824

Drawings illustrate Nominal Proximal Internal Dimensions and Minimum Internal Diameter (I.D.), NOT TO SCALE.

The distal tip and arrangement of the light carrier in the Jackson Anterior Commissure Laryngoscope are constructed for best vision and avoidance of trauma, especially going through the glottis into the trachea without injury to the cords. The scope is long enough to also be used as a tracheoscope in many cases. Supplied with one light carrier. Hook handle. Cable sold separately (pg. 467).

Catalog #	sCope size	overall length	Min i.D.	noMinal proxiMal DiMensi ons	Max o.D.	replaCe Carrier
521820	Child	133 mm	5.8 mm	7.7 x 9.8 mm	13.6 mm	526008
521824	Adult	173 mm	6.8 mm	10 x 11 mm	16.0 mm	526026

Laryngoscopes/Monocular View

HOLINGER ANTERIOR COMMISSURE LARYNGOSCOPIES



522012



522040

The Holinger Anterior Commissure Laryngoscope incorporates the principle of the Yankauer post-nasal speculum. The distal end of the superior surface of the tube rises obliquely and flares laterally and the proximal portion drops obliquely. This increases the lumen and gives a larger field for work by elevating the tuberculum of the epiglottis. Supplied with one light carrier. Cable sold separately (pg. 467).

Catalog #	scope size	overall length	Min i.D.	nominal proximal Dimensions	Max o.D.	replace Carrier
522002	Infant	97 mm	3.7 mm	6 x 9 mm	9.8 mm	526206
522004	Child	120 mm	7.0 mm	8 x 12 mm	13.0 mm	526210
522010	Adult	170 mm	8.3 mm	10 x 14 mm	19.0 mm	526028
522012	Adult Extra-Long	180 mm	8.3 mm	10 x 14 mm	19.0 mm	526038
522040	Adult "Slotted"	170 mm	8.5 mm	10 x 14 mm	19.0 mm	526028
522045	Adult "Slotted"	170 mm	8.2 mm	10 x 19 mm	20.0 mm	526212

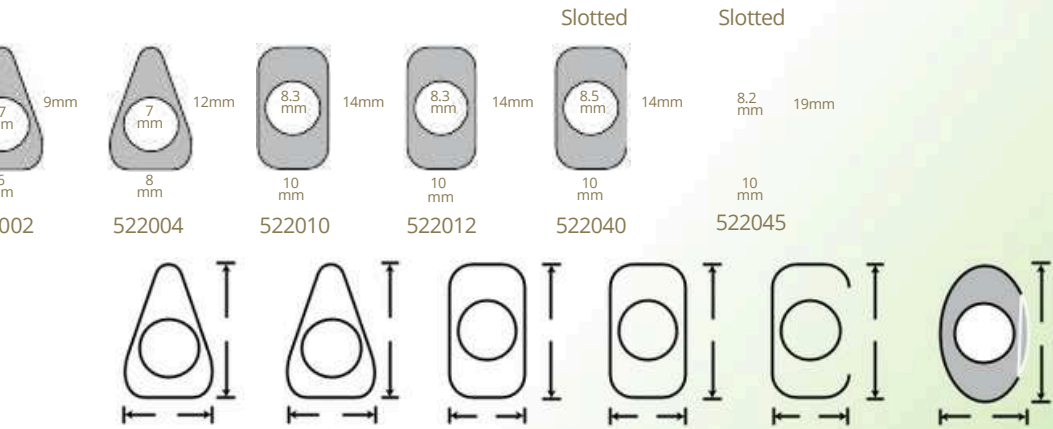

Drawings illustrate Nominal Proximal Internal Dimensions and Minimum Internal Diameter (I.D.), NOT TO SCALE.

LARYNGOSCOPES

Laryngoscopes/Monocular View

HOLINGER "HOURLASS" ANTERIOR COMMISSURE LARYNGOSCOPES



522032

The Holinger "Hour Glass" Anterior Commissure Laryngoscope accentuates the flare tip and enlarged proximal opening of the original Holinger Laryngoscope. The center portion, which is markedly constricted, and the very small light carriers give a minimal external diameter for ease in introduction while providing maximum exposure of the vocal cords for endolaryngeal surgery. Supplied with one light carrier. Cable sold separately (pg. 467).

Catalog #	sCope size	overall length	Min i.D.	noMinal proximal DiMensions	Maxo.D.	replaCe Carrier
522030	Adult	17 mm	7.3 mm	12 x 20 mm	20.2 mm	526212
522032	Adult Extra-Long	181mm	7.3 mm	12 x 20 mm	20.4 mm	526214

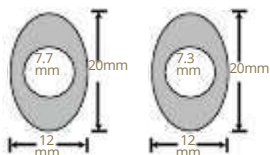

522030

522032

Drawings illustrate Nominal Proximal Internal Dimensions and Minimum Internal Diameter (I.D.), NOT TO SCALE.

HOLINGER "SLOTTED" ANTERIOR COMMISSURE LARYNGOSCOPE



522045

The Holinger "Slotted" Anterior Commissure Laryngoscope is a Holinger "Hour Glass" Laryngoscope that has been modified with an open slot on the working right side of the instrument. This modification allows greater latitude of forceps manipulation and may be useful in vocal cord injection procedures. Supplied with one light carrier.

Catalog #	sCope size	overall length	Min i.D.	noMinal proximal DiMensions	Max o.D.	replaCe Carrier
522045	Adult "Slotted"	170 mm	8.2 mm	10 x 19 mm	20.0 mm	526212

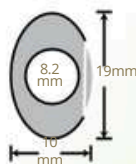

522045

Drawings illustrate Nominal Proximal Internal Dimensions and Minimum Internal Diameter (I.D.), NOT TO SCALE.

LARYNGOSCOPES

Micro-Laryngoscopes/Binocular View

. MICRO-LARYNGOSCOPES

.Micro-Laryngoscopes fulfill the need for maximum illumination and light intensity in microsurgery. The lighting systems on the micro-laryngoscopes provide more than adequate illumination for microsurgery and diagnosis when used under high microscopic magnification. These laryngoscopes were designed with direction from leading surgeons to meet their demanding requirements.



JAKO MICRO-LARYNGOSCOPE TYPE III



522206



522209

The Jako Micro-Laryngoscope Type I has been considered the standard scope for micro-laryngoscopy. However, . offers the Jako Micro-Laryngoscope Type III because of its superior design. It is identical in size and configuration to the Type I and Type II, but the Type III scope features an improved lighting system which diverts the fiberoptic cable out of the way of the surgeon's hands. Additionally, a bifurcated light carrier running down each side of the laryngoscope barrel provides bilateral illumination, which minimizes shadows from the

instruments as they approach vocal cord lesions. Because of these additional benefits, . is pleased to offer the Jako Micro-Laryngoscope Type III. Supplied with one bifurcated light carrier. Cable sold separately (pg. 467).

Catalog#	sCope size	overall length	Min i.D.	noMinal proxiMal DiMensions	Maxo.D.	replaCe Carrier
522206	Adult	178mm	13.4 mm	29.0x20.0mm	34.0mm	526526
522209	Adol.	149mm	11.7mm	25.0 x 13.0 mm	30.0mm	526527
522216	Child	120 mm	9.1 mm	20.0 x 13.0 mm	25.0mm	526528

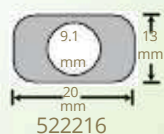
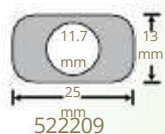
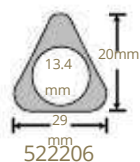

Drawings illustrate Nominal Proximal Internal Dimensions and Minimum Internal Diameter (I.D.), NOT TO SCALE.

LARYNGOSCOPES

Micro-Laryngoscopes/Binocular View

JAKO-CHERRY MICRO-LARYNGOSCOPE TYPE II (NEWBORN)



522220

The Jako-Cherry Micro-Laryngoscope Type II is identical in size and configuration to the Type I. However, the Type II scopes are supplied with two extra-large diameter light carriers permanently connected to 72" light transmission cables (picture pg. 403).

Micro-Laryngoscopes fulfill the need for maximum illumination and light intensity in microsurgery.

Catalog#	size	overall length	Min i.D.	noMinal proxiMal DiMensions	Maxo.D.	replaCe Carrier
522220	Newborn	114mm	7.8mm	18 x 10 mm	25.0 mm	527825 (R) 527820 (L)

* (R) indicates right light carrier, (L) indicates left light carrier
Not to be included in the Catalog Number

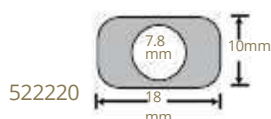

Drawings illustrate Nominal Proximal Internal Dimensions and Minimum Internal Diameter (I.D.), NOT TO SCALE.

DEDO-. MICRO-LARYNGOSCOPE (OUR MOST POPULAR)



522225P

The Dedo- Micro-Laryngoscopes have been designed to provide the ability to examine the vocal cords at the anterior commissure in the majority of patients: for example, patients with bull necks, short jaws or prominent upper teeth. The dimensions of the Dedo- Micro-Laryngoscopes are narrow enough between the light carriers to permit moving the instrument off the incisors and down between the molars to permit visualization of the anterior commissure. The fiber optic light carriers are adjacent to the handle with a metal protected fiber optic bundle which runs in a groove in the handle. When used with the operating microscope equipped with a 400 mm lens, the Dedo- Micro-Laryngoscope affords binocular vision for microendoscopy. Supplied with one bifurcated light carrier. Cable sold separately (pg. 467).

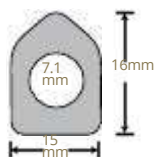

522222

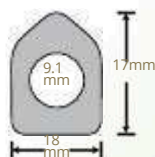

522224

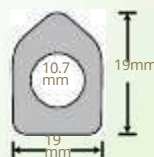

522225P

Drawings illustrate Nominal Proximal Internal Dimensions and Minimum Internal Diameter (I.D.), NOT TO SCALE.

Catalog#	size	overall length	Min i.D.	noMinal proxiMal DiMensions	Maxo.D.	replaCe Carrier
522222	Child	119mm	7.1mm	15.0 x 16.0 mm	22.0mm	526524
522224	Adol.	145mm	9.1mm	18.0 x 17.0 mm	25.0mm	526529
522225P	Adult	178mm	10.7mm	19.0 x 19.0 mm	27.0mm	526525

LARYNGOSCOPES

Micro-Laryngoscopes/Binocular View

ABRAMSON-DEDO MICRO-LARYNGOSCOPE

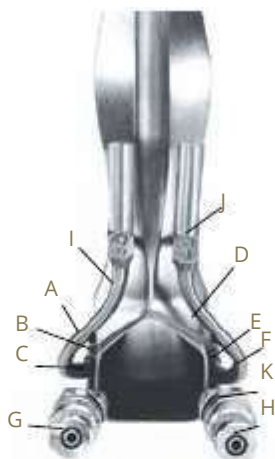

For Difficult Intubations

The Abramson modification of the Dedo- Micro-Laryngoscope was designed to increase the efficiency of Venturi®-type ventilation. It provides the physician with a choice of six positions for placement of the Venturi® Needle (up to 14 Ga.). The inside is finished to be nonreflective, and 14 Ga. blunt needles may be used for smoke evacuation. It comes supplied with a set of right and left light carriers, two 12" 14 Ga. blunt needles and two Luer-Lok® Adapters for use with Sanders system tubing.

Catalog #	size	overall length	Min i.D.	noMinal proximal DiMensions	Max o.D.	replaCe Carrier
522229	Adult	177 mm	12 mm	18.4 x 19mm	28.0 mm	527586 (R) 527587 (L)

* (R) indicates right light carrier, (L) indicates left light carrier
Not to be included in the Catalog Number

Venturi Ventilating Needles

Catalog #	Description
502594	Replacement ventilating needle, 14 Ga., 5-3/8" (13.5 cm)
502600	Replacement ventilating needle, 14 Ga. bent 90 degrees, 4" (10 cm)
522241	Replacement ventilating needle, 14 Ga., blunt, 12" (30.5 cm)



522229

LEGEND

- A,C,D,F Channels for ventilating needle up to 14 gauge
- B,E Channels for light carriers or ventilating needles
- G,H Ventilating needles and adapters
- I,J Light carriers
- K Luer-Lok® Hubs to fit tubing adapter

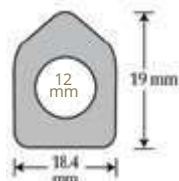

Drawings illustrate Nominal Proximal Internal Dimensions and Minimum Internal Diameter (I.D.), NOT TO SCALE.

522229



522241

LARYNGOSCOPES

Micro-Laryngoscopes/Binocular View

NEW OSSOFF-. MICRO-LARYNGOSCOPE



522190

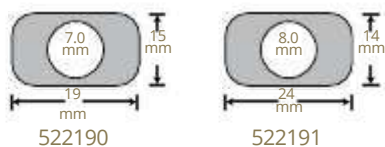

Drawings illustrate Nominal Proximal Internal Dimensions and Minimum Internal Diameter (I.D.), NOT TO SCALE.

Available in two proximal widths. The 25.5 mm width can be introduced in most patients and is easily aligned with the microscope (400 mm objective). The 19 mm scope has the narrowest width capable of absorbing both microscope sight lines and can be used in most patients who previously could accept only the original Holinger scope.

- Holinger distal end, ease of introduction, excellent visualization.
- 19 or 25.5 mm proximal widths, increases patient selection for micro procedures.
- Standard adult handle, can be used with most suspension systems, B.U. suspension handle available as option.
- Single light carrier, external tube dimensions are kept to a minimum.
- Laser finish, laser safety.
- Supplied with one light carrier. Cable sold separately (pictured pg. 467).

Catalog #	size	overall length	Min i.D.	noMinal proximal DiMensions	Max o.D.	replaCe Carrier
522190	Adult	168 mm	7.0 mm	19.0 x	22.0 mm	527864
522191	Adult	168mm	8.0mm	15.0 mm 24.0x 14.0 mm	27.0 mm	527865

. LASER LARYNGOSCOPES

The use of lasers for ablative surgery for tissue removal has become increasingly popular. To meet the demand, a complete line of . Laryngoscopes and Accessories is available for use in laser surgery procedures. All of our laser instruments have a non-reflective, dull finish to reduce the chance of the laser beam reflecting off the instrument.

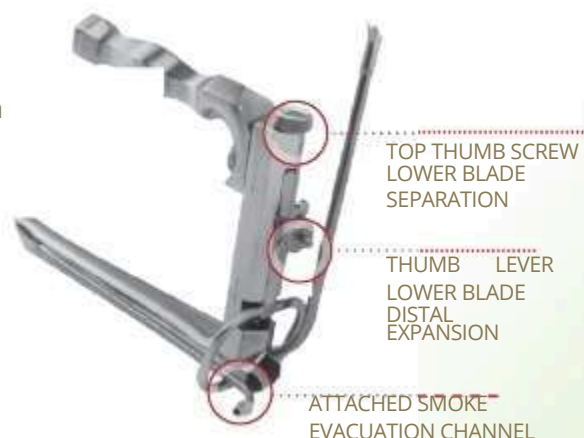

. BIVALVE LASER LARYNGOSCOPES

These special scopes are modified designs of the .-Dedo Anterior Commissure and Ossoff Posterior Commissure Micro and Laser Laryngoscopes.

- The Dedo Anterior Commissure Scopes provide minimal chance of teeth breakage, yet offer optimum microscopic visibility.
- The Ossoff Posterior Commissure Scopes provide the ability to lift the endotracheal tube and permit entrance and microscopic visibility beyond the vocal cords.
- These scopes provide increased visibility at the surgical site through expansion and distension of the split tubes.

- Distal expansion of the lower blade allows maximum visibility of the cords and beyond.
- Non-reflective internal surface minimizes laser beam deflection.
- Removable handle reduces weight during insertion. This handle can be attached to the standard laryngoscope holder (502245), or Tobey Laryngoscope Holder (502248), or adapted for use with the Boston University System (502260).
- Smoke evacuation channel is permanently attached and extends distally for maximum removal of laser plume.
- One large fiberoptic light carrier is supplied with attached cable for optimum distal lighting.

.-DEDODOUBLE-ACTIONLASER LARYNGOSCOPES

- Lower blade separation provides an increased operative area for ease of instrumentation.

Both styles of bivalve Laser Laryngoscopes have O.D. measurements which can exceed the anatomical limits for their intended patient size. A thumb operated lever enables the physician to tactilely gauge the degree of pressure exerted.

DOUBLE-ACTION TYPE WITH LOWER BLADE SEPARATED



DOUBLE-ACTION TYPE WITH LOWER BLADE SEPARATED AND EXPANDED



LARYNGOSCOPES

Laser Micro-Laryngoscopes

DEDO LASER MICRO-LARYNGOSCOPE



The Dedo Laser Micro-Laryngoscope was designed specifically for use with the CO2 laser. It is supplied with two light carriers permanently attached to fiber optic cables (picture pg. 403) and features a non-reflective, dull interior finish. Its large oval light carriers provide maximum illumination, and it contains an integral aspirating channel for automatic smoke and steam evacuation. The same narrow dimensions as the standard Dedo-Micro-Laryngoscope allow its use in many cases in which larger micro-laryngoscopes are contraindicated.

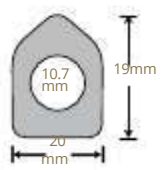

522228

Drawings illustrate Nominal Proximal Internal Dimensions and Minimum Internal Diameter (I.D.), NOT TO SCALE.

522228

Catalog #	sCope size	overall length	Min i.D.	noMinal proximal DiMensions	Maxo.D.	replaCe Carrier
522228	Adult	177 mm	10.7mm	20.0x 19.0mm	32.0 mm	527860

LARYNGOSCOPES

LaserMicro-Laryngoscopes

DEDO-. LASER LARYNGOSCOPE EXTRA-LONG



522243

Designed for the patient with a great distance between the teeth and vocal cords. Supplied with two light carriers permanently attached to fiber optic cables.

Catalog #	sCopesize	overall length	Min i.D.	noMinal ProxiMal DiMensions	replaCe Carrier
522243	Adult X-Long	197mm	12.6mm	20.0x20.0mm	527860

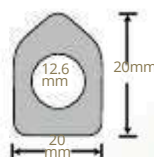

Drawings illustrate Nominal Proximal Internal Dimensions and Minimum Internal Diameter (I.D.), NOT TO SCALE.

522243

SINGLE ONE-PIECE FIBER OPTIC LIGHT CARRIERS/CABLES

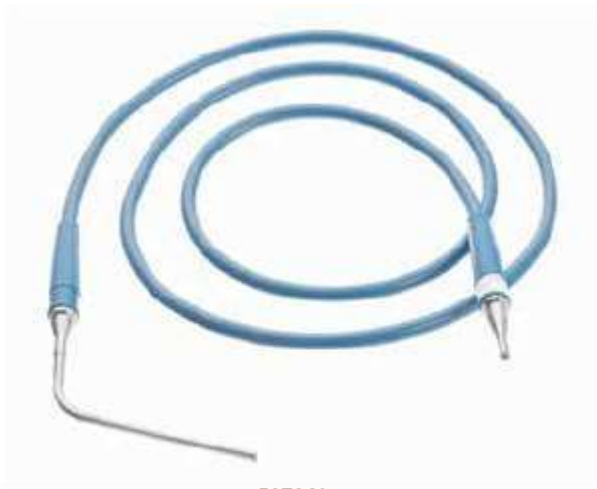

527860

Light carriers are permanently attached to fiber optic cables which provide maximum illumination.

light Carrier/ Cable#	sCope
527800 (L)	522232 Ossoff-Karlan-Jako Laser Laryngoscope, adult
527805 (R)	522232 Ossoff-Karlan-Jako Laser Laryngoscope, adult
527820 (L)	522220 Jako-Cherry Laryngoscope Type II, newborn
527825 (R)	522220 Jako-Cherry Laryngoscope Type II, newborn
527830 (R)	522242 Healy-Jako Pediatric Subglottiscope
527835 (L)	522242 Healy-Jako Pediatric Subglottiscope
527850	522311 Improved Tucker Mediastinoscope, long
527853	522306 Improved Tucker Mediastinoscope, short
	522228 Dedo Laser Laryngoscope
	522231 Ossoff-Karlan-Dedo Laser Laryngoscope
	522233 Ossoff-Karlan Posterior Commissure
527860	522243 Dedo Laser Laryngoscope, extra-long
	522244 Ossoff Adult Subglottiscope, female
	522245 Ossoff Adult Subglottiscope, male
	522290 . Dedo DA Laryngoscope, adult
	522291 .-Ossoff Double-Action Laryngoscope
527862	522238 Ossoff-Karlan Adolescent Laser Laryngoscope
527863	522237 Ossoff Karlan Child Laser Laryngoscope
	522292 . Dedo DA Adolescent Laryngoscope

* (R) indicates right light carrier, (L) indicates left light carrier
Not to be included in the Catalog Number

LARYNGOSCOPES

Laser Micro-Laryngoscopes

OSSOFF-KARLAN-DEDO LASER MICRO-LARYNGOSCOPES



522231



522237

The Ossoff-Karlan-Dedo Laser Micro-Laryngoscopes are modifications of the Dedo and Jako Micro-Laryngoscopes with additions of special features for laser surgery. Supplied with two light carriers permanently attached to cables (picture pg. 403). Features:

- Bifurcated smoke evacuation channels.
- Non-reflective, dull interior finish.
- Large oval light carriers for maximum illumination.

Catalog #	size	overall length	Min i.D.	noMinal proximal DiMensions	Max o.D.	replaCe Carrier
522231	Adult	178 mm	11.9 mm	22.0x20.0 mm	35.0 mm	527860
522237	Child	130 mm	9.8mm	18.0x18.0 mm	30.0 mm	527863
522238	Adol.	152 mm	9.7mm	21.0x20.0 mm	33.0 mm	527862

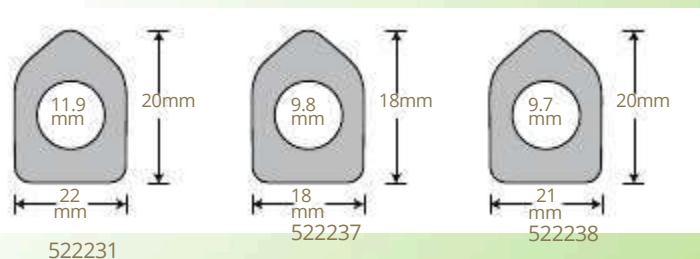

Drawings illustrate Nominal Proximal Internal Dimensions and Minimum Internal Diameter (I.D.), NOT TO SCALE.



522238

LARYNGOSCOPES

Laser Micro-Laryngoscopes

OSSOFF-KARLAN-JAKO LASER MICRO-LARYNGOSCOPE



522232

The Ossoff-Karlan-Jako Laser Micro-Laryngoscope is a modification of the Jako Micro-Laryngoscope with additions of special features for laser surgery. This interior commissure scope is a special design of Drs. Ossoff and Karlan. Supplied with two light carriers permanently attached to cables. Features:

- Bifurcated smoke evacuation channels.
- Non-reflective, dull interior finish.
- Large oval light carriers for photography.

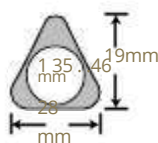

522232

Drawings illustrate Nominal Proximal Internal Dimensions and Minimum Internal Diameter (I.D.), NOT TO SCALE.

Catalog #	sCope size	overall length	Mini.D.	noMinal proximal DiMensions	Maxo.D.	replaCe Carrier
522232	Adult	178 mm	13.4 mm	28.0 x 19.0 mm	38.0 mm	527805(R) 527800(L)

* (R) indicates right light carrier, (L) indicates left light carrier
Not to be included in the Catalog Number

NEW OSSOFF-. MICRO-LARYNGOSCOPE (LASER FINISH)



522190

Available in two proximal widths. The 25.5 mm width can be introduced in most patients and is easily aligned with the microscope (400 mm objective). The 19 mm scope has the narrowest width capable of absorbing both microscope sight lines and can be used in most patients who previously could accept only the original Holinger scope.

- Holinger distal end, ease of introduction, excellent visualization.
- 19 or 25.5 mm proximal widths, increases patient selection for micro procedures.
- Standard adult handle, can be used with most suspension systems, B.U. suspension handle available as option.
- Single light carrier, external tube dimensions are kept to a minimum.
- Laser finish, laser safe.
- Supplied with one light carrier. Cable sold separately (pg. 467).

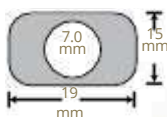

522190

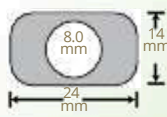

522191

Drawings illustrate Nominal Proximal Internal Dimensions and Minimum Internal Diameter (I.D.), NOT TO SCALE.

Catalog #	sCope size	overall length	Min i.D.	noMinal proximal DiMensions	Max o.D.	replaCe Carrier
522190	Adult	168 mm	7.0 mm	19.0 x 15.0 mm	22.0 mm	527864
522191	Adult	168 mm	8.0 mm	24.0 x 14.0 mm	27.0 mm	527865

LARYNGOSCOPES

LaserMicro-Laryngoscopes

OSSOFF-KARLAN POSTERIOR COMMISSURE MICRO-LARYNGOSCOPE



522233

This posterior commissure scope is a special design of Drs. Ossoff and Karlan. Supplied with two light carriers permanently attached to cables. Features:

- Bifurcated smoke evacuation channels.
- Non-reflective, dull interior finish.
- Large oval light carriers for maximum illumination.

Catalog#	sCope size	overall length	Min i.D.	noMinal proximal DiMensions	Max o.D.	replaCe Carrier
522233	Adult	177mm	12.6mm	22.0x19.0mm	35.0mm	527860

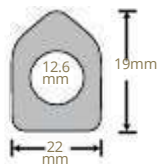

522233

Drawings illustrate Nominal Proximal Internal Dimensions and Minimum Internal Diameter (I.D.), NOT TO SCALE.

DEDO DOUBLE-ACTION ANTERIOR COMMISSURE LARYNGOSCOPES



522290

. Bivalve Laser Laryngoscopes are modified designs of the .-Dedo Anterior Commissure and Ossoff Posterior Commissure Micro and Laser Laryngoscopes. Supplied with one light carrier permanently attached to fiber optic cable.

Catalog#	sCope size	overall length	CloseD Min i.D.	noMinal proximal DiMensions	CloseD Maxo.D.	replaCe Carrier
522290	Adult	179mm	12.7mm	22.0 x 20.0mm	33.0mm	527860
522292	Adol.	136mm	9.8mm	21.0x26.0mm	32.0mm	527863



522292

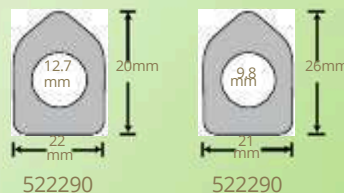

522290

522290

Drawings illustrate Nominal Proximal Internal Dimensions and Minimum Internal Diameter (I.D.), NOT TO SCALE.

LARYNGOSCOPES

Laser Micro-Laryngoscopes

OSSOFF DOUBLE-ACTION POSTERIOR COMMISSURE LARYNGOSCOPE



522291

The Ossoff Posterior Commissure Scope provides the ability to lift the endotracheal tube and permit entrance and microscopic visibility beyond the vocal cords. This scope provides increased visibility at the surgical site through expansion and distension of the split tubes. Supplied with one light carrier permanently attached to fiber optic cable for maximum illumination.

Catalog #	sCope size	overall length	Min i.D.	noMinal proximal DiMensions	replaCe Carrier	CloseD Maxo.D.
522291	Adult	178 mm	12.7 mm	22.0 x 26.0 mm	527860	33.0 mm

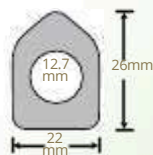

522291

Drawings illustrate Nominal Proximal Internal Dimensions and Minimum Internal Diameter (I.D.), NOT TO SCALE.

SUBGLOTTISCOPE

Laser Subglottiscope

HEALY-JAKO PEDIATRIC SUBGLOTTISCOPE



522242

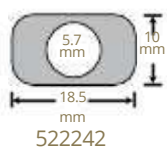

Drawings illustrate Nominal Proximal Internal Dimensions and Minimum Internal Diameter (I.D.), NOT TO SCALE.

522242



502600



502599

The Healy-Jako Subglottiscope was designed specifically for the pediatric patient. The small tapered 6 mm distal tip allows the subglottiscope to pass farther down the airway and give access to lesions below the level of the vocal cords, while still being able to utilize the operating microscope. Supplied with light carriers permanently attached to fiber optic cables. Features:

- Non-reflective, matte interior finish. This finish decreases the chance of the laser beam reflecting off the inside of the scope and burning unintended tissue. The subglottiscope is most useful when the carbon dioxide laser is used.
- Disconnect handle. Subglottiscope can be held by standard laryngoscope holder 502245 or Tobey 502248. When the handle is unscrewed, the subglottiscope can be easily inserted and manipulated.
- Large fiber optic light carriers. The large cables allow for maximum illumination and light intensity.
- Removable 14 Ga., 3-7/8" (10 cm) ventilating needle.
- Needle locking mechanism and tubing clip on the handle.
- Assures proper placement and hold of ventilating needle while keeping tubing out of the way.
- Includes 502599 Luer-Lok® Hub Adapter to Sanders tubing.

Catalog #	overall length	Min i.D.	noMinal proximal DiMensions	Maxo.D.	replaCe Carrier
522242	155mm	5.7mm	18.5x 10.0mm	29.0mm	527830(R) 527835(L)
502600	Replacement Ventilating Needle				
502599	Replacement Luer-Lok® Adapter				

* (R) indicates right light carrier, (L) indicates left light carrier
Not to be included in the Catalog Number

SUBGLOTTISCOPE

Laser Subglottiscope Instrumentation

MICROSUBGLOTTIC INSTRUMENTS

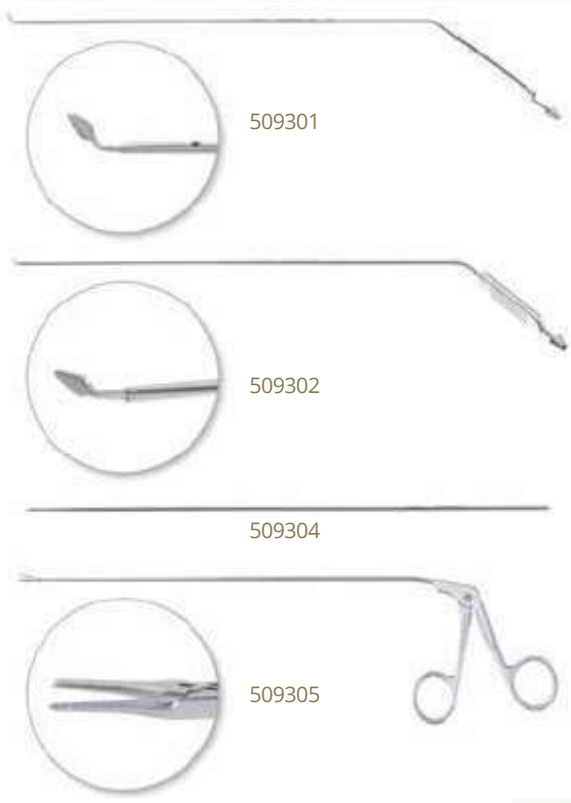

Designed for laser microsurgery of the entire subglottic space and upper cervical trachea, this instrumentation includes forceps, probe, mirror and platform (all 28 cm in length and laser finished).

Catalog #	Description
509301	Operating platform, 3 mm
509302	Front surface mirror, 3 mm
509304	Straight probe
509305	Grasping forceps, straight

LARYNGOSCOPES

Video Laryngoscopes

NEW VIDEO LARYNGOSCOPE SYSTEMS



522226

522194



524060

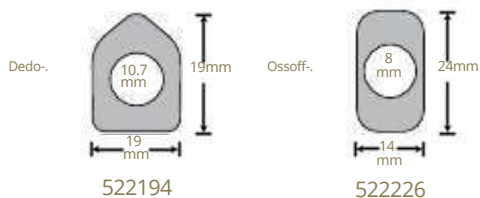

522194

522226

Drawings illustrate Nominal Proximal Internal Dimensions and Minimum Internal Diameter (I.D.), NOT TO SCALE.

Teleflex provides . brand Ossoff and Dedo-design Video Laryngoscopes that now include dual channels for increased versatility. The dual channel design allows the surgeon to position the telescope, suction tube or light carrier wherever it is most comfortable and is thus helpful for the left-handed surgeon. The Video Laryngoscope System is an ideal resource for training and education since the telescope can be connected to most video systems for visualization of the surgical site. The 0 degree telescope (4 mm x 177 mm) features a forward view with a right angle eyepiece to ensure that it is not in the surgeon's way. This . Telescope can be autoclaved. The telescope eyepiece will accept any standard C-mount video coupler. The fiber optic terminal of the light carrier accepts ACMI style cable connections. Each complete Video Laryngoscope System includes a laryngoscope, telescope, suction tube and light carrier. Trays are optional; see pg. 412.

- 522194 Ossoff-. Dual Channel Video Laryngoscope System
Adult, 16.8 cm length
Minimal internal diameter: 8 mm
Nominal proximal dimensions: 24 x 14 mm
- 522226 Dedo-. Dual Channel Video Laryngoscope System
Adult, 17.3 cm length
Minimal internal diameter: 10.7 mm
Nominal proximal diameter: 19 x 19 mm
- 527867 Replacement Light Carrier for 522194 or 522226
- 522195 Replacement Suction Tube for 522194 or 522226
- 522195 Replacement Telescope for 522193, 522194 and 522226
- 524060 4 mm x 177 mm, 0 degrees forward, with a 90 degree eyepiece.
This telescope can be autoclaved

LARYNGOSCOPES

Video Laryngoscopes

STORAGE TRAYS



508002



508004

. Trays are designed for microsurgical and other delicate instruments. These lightweight, durable trays are engineered for maximum protection and flexibility. The transparent lid will help you easily identify instruments. These trays can withstand repeated exposure to steam, ethylene oxide and cold methods.

Description

Catalog

Telescope Tray

Includes silicone stabilizer bars to secure telescope during storage

9-1/2" x 5-1/2" x 2-1/2" (24 x 14 x 6.5 cm)

Video Laryngoscope Tray

Includes silicone finger mat. Tray size will accommodate laryngoscope and fiber-optic cable

9" x 13" x 3-1/4" (23 x 33 x 8 cm)

508002

508004

LARYNGOSCOPES

Laryngoscope Holders

Laryngoscope Holders enable the surgeon to have both hands free during Laryngoscopy, Micro-Laryngoscopy and Laser Laryngoscopy procedures. These holders allow the surgeon to perform intricate procedures requiring both hands available for necessary instrumentation insertion through the laryngoscopes.

BOSTON UNIVERSITY SUSPENSION SYSTEM



502260

This system is used to suspend the laryngoscope during micro and laser surgery of the larynx. Laryngoscope and Strong Laryngoscope Handle Extension (502261) are not included.

- Supports the laryngoscope for two-handed surgery.
- Is not affected by chest movement.
- Allows use of the Boyce-Jackson position.
- Allows repositioning of the table as necessary without readjustment of the suspension system.

Catalog #	Description
502260	Includes . Table Clamp (163100) and Pivoting Extension Arm Assembly (502262)
163100	. Table Clamp
502261	BU System Laryngoscope Handle
502262	BU Pivoting Extension Arm Assembly

Boston University Suspension System Scope Service to adapt handle for use with BU System. All laryngoscopes must be tapped for use with the BU System.

502261 BU System Laryngoscope Handle – must be ordered along with scope for use with BU Suspension System.

Contact Teleflex® Customer Service to have your laryngoscope tapped.



163100



502261



502262

LARYNGOSCOPES

Laryngoscope Holders

BOSTON UNIVERSITY SYSTEM PIVOTING EXTENSION ARM ASSEMBLY



502262

Catalog #
502262

Description
BU Pivoting Extension Arm Assembly,
overall length 10" (25.5 cm)

BOSTON UNIVERSITY SYSTEM LARYNGOSCOPE HANDLE



502261

Adapts micro-laryngoscope for use with the Boston University Suspension System. Laryngoscopes already in use may be returned to Teleflex® Instrument Repair for the modification or a new instrument may be ordered with this extension. Contact your local surgical representative for more information

catalog#
502261

Description
BU System Laryngoscope Handle, 2-1/2" (6.5 cm)

DEDO TABLE-MOUNTED MAYO TRAY



502265

The Dedo Table-Mounted Mayo Tray System is used to support the standard . Laryngoscope Holder (502248/502245). The tray can be positioned at any height, will swivel and can be extended. All parts are stainless steel and can be disassembled for cleaning and sterilizing. This system can be easily covered by a sterile Mayo cover.

Catalog #

Description
Complete system:
Tray

502265

Detachable Sliding Bars and Clamps
Upright Rod
. Table Clamp (163100)

LARYNGOSCOPES

Laryngoscope Holders

NEW TOBEY LARYNGOSCOPE HOLDER (MOST POPULAR)



502248

The Tobey Laryngoscope Holder is the newest version of . Laryngoscope holders. It has a quick attach/release mechanism that provides a secure hold of your laryngoscope. The Tobey eliminates the twisting and turning necessary to lock the laryngoscope into the holder. It allows for fine adjustments using the size adjustment knob for different laryngoscope handles.

Catalog #	Description
502248	Tobey Laryngoscope Holder

LARYNGOSCOPE HOLDER



502245

The external chest bar and rod easily attach to or detach from the handle of most laryngoscopes. Manually operated gear supplies leverage to the laryngoscope for exposure of the anterior commissure and allows the operator to have both hands free for instrumentation.

Catalog #	Description
502245	Laryngoscope Holder, Improved Model (Laryngoscope is not included)

TABLE CLAMP



163100

Catalog #	Description
163100	Clamp for Dedo Mayo Tray (502265) and Boston University Suspension System (502260)

LARYNGOSCOPES

Venturi Anesthesia Devices

VENTURI ADAPTERS FOR BRONCHOSCOPES AND LARYNGOSCOPES



502562

Flow and pressure characteristics vary greatly according to the design of the bronchoscope or laryngoscope and any new combination should be studied carefully before clinical use. Note: The Sanders Venturi System can be used only with tapered scopes.

Catalog #	Description
502562	Albert-Sanders Venturi Adapter for laryngoscopes
502566	Sanders Venturi Adapter for . Bronchoscope 15 mm sidearm



502566

TYGON TUBING WITH LUER-LOK® CONNECTOR



502574

Used in conjunction with Luer-Lok® connector 502599 to fit into toggle valve. The bare end of the tubing connects to the Venturi Adapters for Bronchoscopes and Laryngoscopes, 502562 and 502566.

Catalog #	Description
502574	Adapter is 4 mm O.D. x 2.5 mm I.D.

LARYNGOSCOPES

Venturi Anesthesia Devices

VENTURI VENTILATING NEEDLES



502594

Catalog #
502594

Description
Replacement needles for 522229 Abramson-Dedo Micro-Laryngoscopes, 14 Ga., 5-3/8" (13.5 cm)
Replacement needles for 522244 and 522245 Ossoff Adult Subglottiscopes, 522242 Healy-Jako Pediatric Subglottiscope and 522229 Abramson-Dedo Micro-Laryngoscope, 14 Ga. bent 90 degrees, 4" (10 cm)
Replacement needles for 522229 Abramson-Dedo Micro-Laryngoscope, blunt, 14 Ga., 12" (30.5 cm)

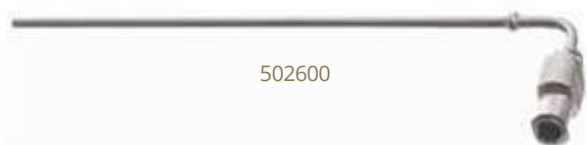

502600

502600



522241

522241

REPLACEMENT LUER-LOK® HUB ADAPTER



502599

Catalog #
502599

Description
Needle Luer-Lok® to Sanders Tubing, 1-1/8" (3 cm)

REPLACEMENT CLIPS



522240

Catalog #
522240

Description
For securing Venturi Ventilating Needles, 5/8" (1.5 cm)

INSTRUMENTATION FOR LARYNGOSCOPES

Forceps

LARYNGEAL INSTRUMENTATION FOR LARYNGOSCOPES AND MICRO-LARYNGOSCOPES

Laryngeal Instruments are designed in conjunction with leading otolaryngology surgeons. These instruments can be utilized for both Laryngoscopy and Micro-Laryngoscopy. Surgeons continue to provide feedback for new designs and modifications as procedural changes occur.

JACKSON CROSS ACTION FORCEPS



For anesthetizing the larynx by blocking the superior laryngeal nerves. Stainless steel.

Catalog #	Description
507375	24 cm length from proximal end of handle to curve

JACKSON LARYNGEAL CUP FORCEPS - STANDARD LIGHTWEIGHT 4 AND 6 MM CUPS

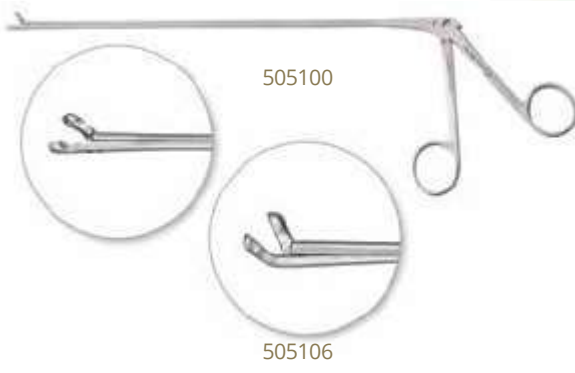

Jackson Forceps come in standard and extra lightweight construction that provides durability and strength. The jaw size, shape and angle are specially calculated for use through Jackson scopes.

Catalog #	Description
505100	Straight, 4 mm diameter jaw, working length 28 cm
505102	Straight, 6 mm diameter jaw, working length 28 cm
505104	Angled, 4 mm diameter jaw, working length 28 cm
505106	Angled, 6 mm diameter jaw, working length 28 cm

INSTRUMENTATION FOR LARYNGOSCOPES

Forceps

JACKSON LARYNGEAL CUP FORCEPS - EXTRA LIGHTWEIGHT 2 MM CUPS



Jackson Forceps come in standard and extra lightweight construction that provides durability and strength. The jaw size, shape and angle are specially calculated for use through Jackson scopes.

Catalog #	Description
505110	Straight, 2 mm diameter jaw, working length 20 cm
505112	Straight, 2 mm diameter jaw, working length 28 cm
505114	Angled, 2 mm diameter jaw, working length 20 cm
505116	Angled, 2 mm diameter jaw, working length 28 cm

JACKSON TRIANGULAR PUNCH SPECIMEN AND TISSUE FORCEPS

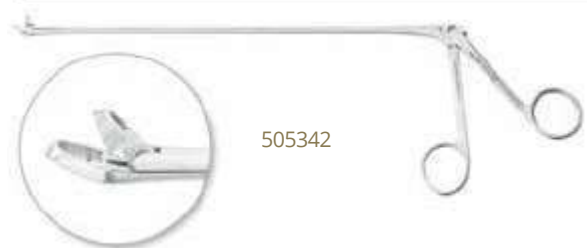

Shear-type forceps remove a piece of tissue approximately 3.5 x 7 mm. Will pass through laryngoscope 10 mm or larger.

Catalog #	Description
505342	Angled jaws, working length 11-1/8" (28.5 cm)

INSTRUMENTATION FOR LARYNGOSCOPES

Forceps

LORE SUBGLOTTIC SPECIMEN AND TISSUE FORCEPS

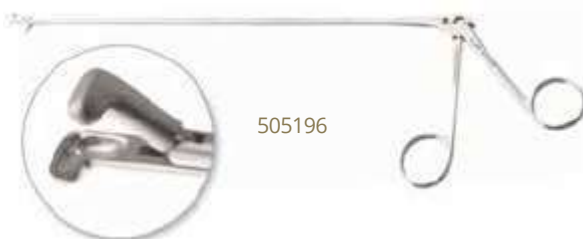

Jaws angled 90 degrees upward and open to the right or left. Working length 11-1/8" (28.5 cm).

Catalog #	Description
505195	Opens to right, 6 mm jaw
505196	Opens to left, 6 mm jaw

PATTERSON ELONGATED CUP BITING FORCEPS



Catalog #	Description
505230	Regular, 4 mm width jaw, working length 11-1/8" (28.5 cm)

NORRIS SPONGE HOLDING FORCEPS



Bayonet-shaped, cross action forceps designed for use in mediastinoscopy. Straight distal portion of jaw is 16 cm long.

Catalog #	Description
506747	13-1/8" (33 cm)

INSTRUMENTATION FOR LARYNGOSCOPES

Suction Tubes

INSULATED CAUTERY SUCTION TUBE



507045

With thumb-valve for controlled suction, 4 mm diameter, 12 Fr.

Catalog#	Description
507045	Working length 8-5/8" (22 cm), supplied with a 10 ft. Bovie cord and plug (507046)
507046	10 ft. Bovie cord and plug with connection to fit insulated suction cautery tube. Cord only.

JACKSON OPEN END ASPIRATING TUBE

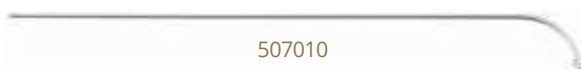

507010

. Aspirating Tubes, except in special designs, are constructed of stainless steel. They are measured in working length from distal tip to beginning of proximal curve or angle. Aspirating tubes should be 5 cm or 10 cm longer than the scope through which they are used.

Catalog#	Working length	For Use thrU sCope	UBeDiaMeter
507010	20cm	5.0 mm or larger	4mm(12Fr.)

JACKSON "VELVET-EYE" ASPIRATING TUBES



507030

These tubes have a smooth, oval-shaped opening on each side of the distal tip and a closed, blunt end.

Catalog#	Working length	For Use thrU sCope	UBeDiaMeter
507030	20cm	5.0 mm or larger	4mm(12Fr.)

STRONG SUCTION IRRIGATOR

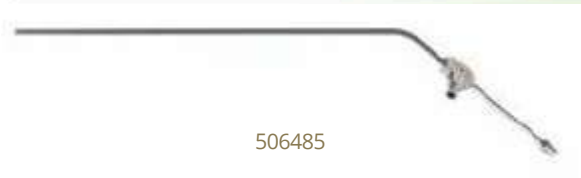

506485

For washing dyed vocal cords with saline.

Catalog#	Description
506485	9" (23 cm)

INSTRUMENTATION FOR LARYNGOSCOPES

Micro-Laryngeal/Feder-Ossoff

FEDER-OSSOFF MICRO-LARYNGEAL GRASPING FORCEPS



Feder-Ossoff forceps include alligator grasping and cup biopsy jaws. All forceps have a matte laser finish and shafts that taper from 2 mm to 0.5 mm.

Double-action grasping forceps have aggressive serrated jaws for better holding and a suction channel with a Luer-Lok® proximal fitting for smoke evacuation and improved visibility during laser procedures.

Grasping forceps have finely serrated jaws, 1.1 mm wide tapering to 0.6 mm, 4 mm long and a working length of 23 cm.

Delicate biopsy cup forceps have a 1 mm jaw with a working length of 23 cm.

Catalog #	Description
506856	Grasping forceps, double action, straight, with suction
506858	Grasping forceps, angled up
506860	Grasping forceps, straight
506862	Cup biopsy, 1 mm, straight
506864	Cup biopsy, 1 mm, angled up

INSTRUMENTATION FOR LARYNGOSCOPES

Micro-Laryngeal/Feder-Ossoff

. FEDER-OSSOFF PHONOSURGERY SET

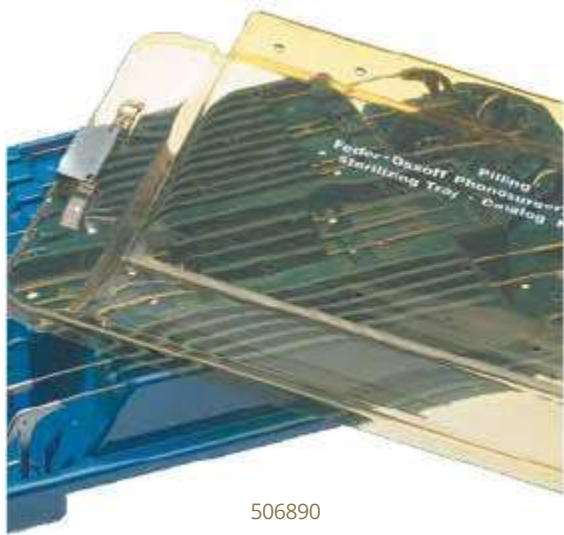

506890

. Feder-Ossoff Micro-Laryngeal Precision Instruments from Teleflex® are designed for microlaryngeal procedures to retain, restore or improve voice quality. Feder-Ossoff instruments are specially designed for phonosurgery/microflap surgery with Mayo blades on the scissors and angled handles with slender diameter shafts. Set includes 27 instruments for use in delicate mucosal microflap dissection techniques.

- Mayo blades on scissors
- Matte laser finish
- Angled handles and slender diameter shafts
- Universal ring handle for knives and probes
- 23-27 cm working length
- Durable storage and tray

Catalog #	Description
506800	Feder-Ossoff Phonosurgery Set Contains 27 Instruments, 506802-506890 (pgs. 422-424)
506890	Instrument Tray 11-3/4" x 15-1/4" x 3" (38.5 x 30 x 7.5 cm) at handles

INSTRUMENTATION FOR LARYNGOSCOPES

Micro-Laryngeal/Feder-Ossoff

FEDER-OSSOFF MICRO-LARYNGEAL SCISSORS



Scissors are designed with blunt or sharp tips and come in a variety of patterns to enable easier access and better exposure. All scissors have a 23 cm working length, a 2 mm diameter shaft and a 5 degree bend at the handle for better exposure.



506802



506804



506806



506808



506810



506822



506812



506814



506816



506818



506820



506824

Catalog#	Description
506802	Blunt, straight blades, vertical action
506804	Blunt, curved blades, horizontal action, open left
506806	Blunt, curved blades, horizontal action, open right
506808	Blunt, angled up, vertical action
506810	Blunt, angled down, vertical action
506822	Blunt, angled up, double action
506812	Sharp, straight blades, vertical action
506814	Sharp, curved blades, horizontal action, open left
506816	Sharp, curved blades, horizontal action, open right
506818	Sharp, angled up, vertical action
506820	Sharp, angled down, vertical action
506824	Sharp, double action

INSTRUMENTATION FOR LARYNGOSCOPES

Micro-Laryngeal/Feder-Ossoff

KNIVES AND KNIFE HANDLE

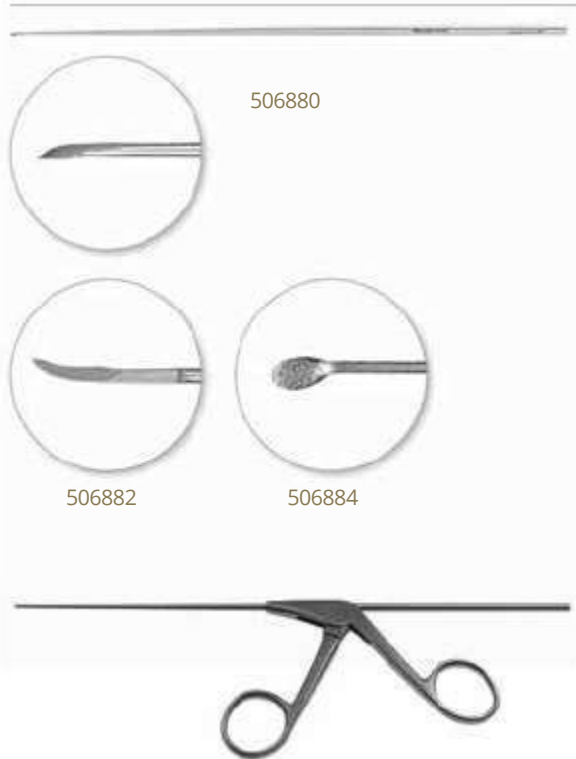

All knives have 27 cm maximum working length and a 3.2 - 1 mm tapered shaft. Working length is measured from front portion of handle to tip of instrument.

Catalog #	Description
506880	Straight sickle, 3 mm blade
506882	Curved sickle, 3 mm blade
506884	Phono circle knife, 3 mm blade
506888	Universal ring handled knife handle with camlock



506888

Shown with probe inserted into handle. Knives and probes can be set to any angle or depth relative to the handle.

PROBE/ELEVATORS

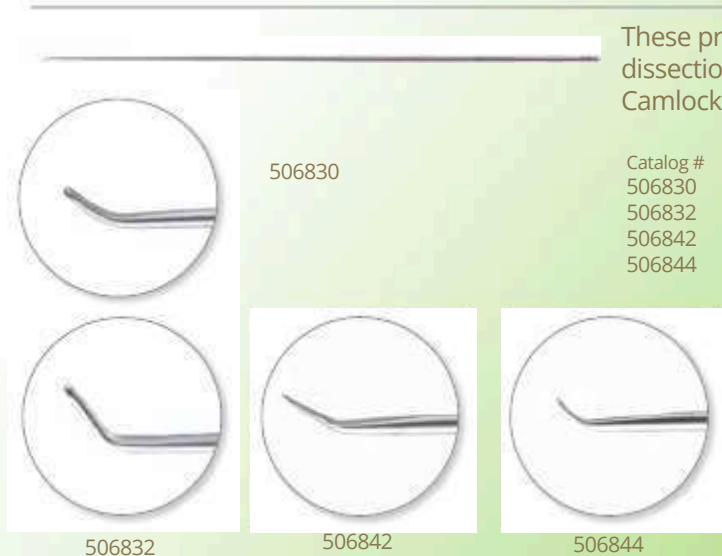

These probe/elevators allow for sharp and blunt dissection and elevating of tissue. All probes fit into the Camlock Handle (506888). 27 cm working length.

Catalog #	Description
506830	30 degree angle, blunt
506832	60 degree angle, blunt
506842	30 degree angle, sharp
506844	60 degree angle, sharp

506832

506842

506844

INSTRUMENTATION FOR LARYNGOSCOPES

Micro-Laryngeal/Feder-Ossoff

SUCTIONS

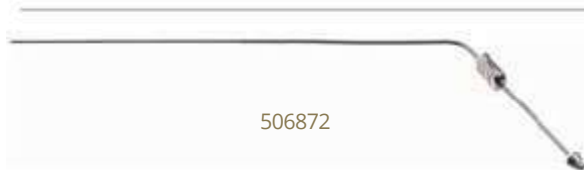

506872

23 cm working length with thumb control, laser finish.

Catalog #	Description
506870	3 Fr. diameter
506872	5 Fr. diameter
506874	7 Fr. diameter

FEDER-OSSOFF PHONOSURGERY INSTRUMENT TRAY



506890

Has individual instrument housing. The tray is a durable construction, protecting the delicate instruments. This tray may be stacked for storage.

Catalog #	Description
506890	Inside dimensions: 11-3/4" x 15-1/4" x 3" (30 x 38.5 x 7.5 cm) at handles

INSTRUMENTATION FOR LARYNGOSCOPES

Micro-Laryngeal/Feder-Ossoff

MICRO-LARYNGEAL FORCEPS



The serrated triangular jaw allows for a larger surface area of tissue to be grasped within the 3 mm wide tips. These forceps have a 23 cm working length and a non-reflective finish for use with lasers. Jaws are uniquely angled and fenestrated to better grasp along the longitudinal surface of the respective cord, 2.75 mm wide triangular jaw, serrated jaw, 2 mm shaft. Fits adult laryngoscopes without interfering with microscope, 5 degree bend at the handle. Non-reflective finish; can be used in laser surgery.

Catalog#	Description
506950	Triangular fenestrated, serrated jaw forceps, right, working length 9-1/4" (23.5 cm)
506952	Triangular fenestrated, serrated jaw forceps, left, working length 9-1/4" (23.5 cm)

Micro-Laryngeal/Jako-Kleinsasser

JAKO-KLEINSASSER MICRO-LARYNGEAL CUP FORCEPS (MOST COMMON & ESSENTIAL)



These . Micro-Laryngeal Cup Forceps were designed specifically for everyday-use micro-surgery. They feature slender 2 mm diameter stems with miniature distal jaws in the shape of cup forceps and are made of dull finished stainless steel to reduce glare. Stems are angulated (5 degree bend at handle) for unobstructed vision and all have a 22 cm working length.



506460

506461

Catalog#	Description
506455	Straight
506460	Angled left
506461	Angled right
506462	Angled up
506463	Oval, single action
506465	Straight oval



506462

506463

506465

INSTRUMENTATION FOR LARYNGOSCOPES

Micro-Laryngeal/Jako-Kleinsasser

JAKO-KLEINSASSER MICRO-LARYNGEAL GRASPING FORCEPS



These .Micro-Laryngeal Grasping Forceps were designed specifically for everyday-use micro-surgery. They feature slender 2 mm diameter stems with miniature distal jaws in the shape of grasping forceps and are made of dull finished stainless steel to reduce glare. Stems are angulated (5 degree bend at handle) for unobstructed vision and all have a 22 cm working length.

Catalog #	Description
506470	Curved left
506471	Curved right
506472	Straight, very fine serrated

JAKO-KLEINSASSER MICRO-LARYNGEAL SCISSORS



These .Micro-Laryngeal Scissors were designed specifically for everyday-use micro-surgery. They feature slender 2 mm diameter stems with miniature distal jaws in the shape of scissors and are made of dull finished stainless steel to reduce glare. Stems are angulated (5 degree bend at handle) for unobstructed vision and all have a 22 cm working length.

Catalog #	Description
506475	Curved left
506476	Curved right
506477	Angled up
506478	Straight, vertical
506479	Straight, horizontal

INSTRUMENTATION FOR LARYNGOSCOPES

Micro-Laryngeal/Jako

JACKSON LARYNGEAL SCISSORS

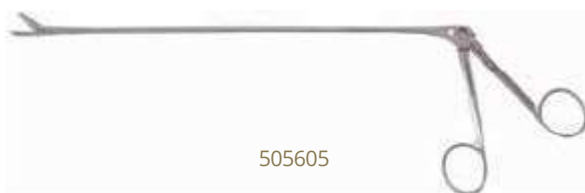

Catalog #
505605

Description
Straight, 7-7/8" (20 cm) long blades, working length
11-1/8" (28.5 cm)

JAKO COAGULATION PROBE

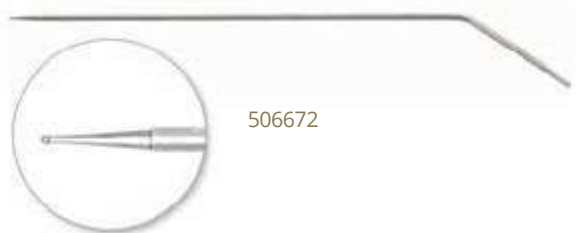

Will fit standard Bovie Pencil Handle.

Catalog #
506672

Description
Working length 8-1/4" (21 cm)

JAKO FINE BALL TIP HOOK

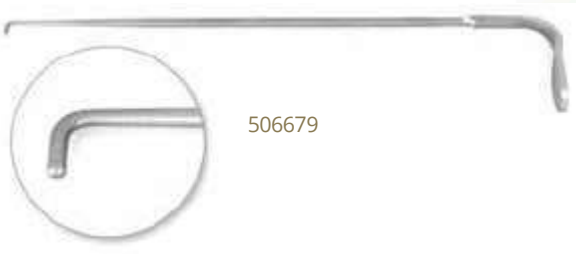

Catalog #
506679

Description
Right angle, 9" (23 cm)

INSTRUMENTATION FOR LARYNGOSCOPES

Micro-Laryngeal/Jako

JAKO MIRROR

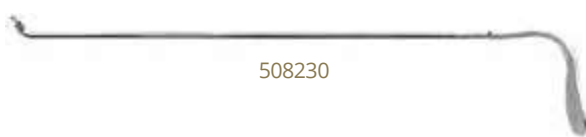

508230

For minor examination of the undersurface of the vocal cords.

Catalog #	Description
508230	Working length 8-1/4" (21 cm)

JAKO SICKLE KNIFE



506680

Catalog #	Description
506680	10-1/4" (26 cm)

JAKO FINE SUCTION TUBES

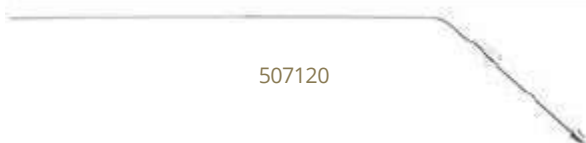

507120

Specially designed with thumb control.

Catalog #	Description
507120	No. 00, 5 Fr., 23 cm working length
507121	No. 0, 6 Fr., 23 cm working length
507122	No. 1, 7 Fr., 23 cm working length

INSTRUMENTATION FOR LARYNGOSCOPES

Micro-Laryngeal/Jako

JAKO RIGID STEM INSTRUMENTS

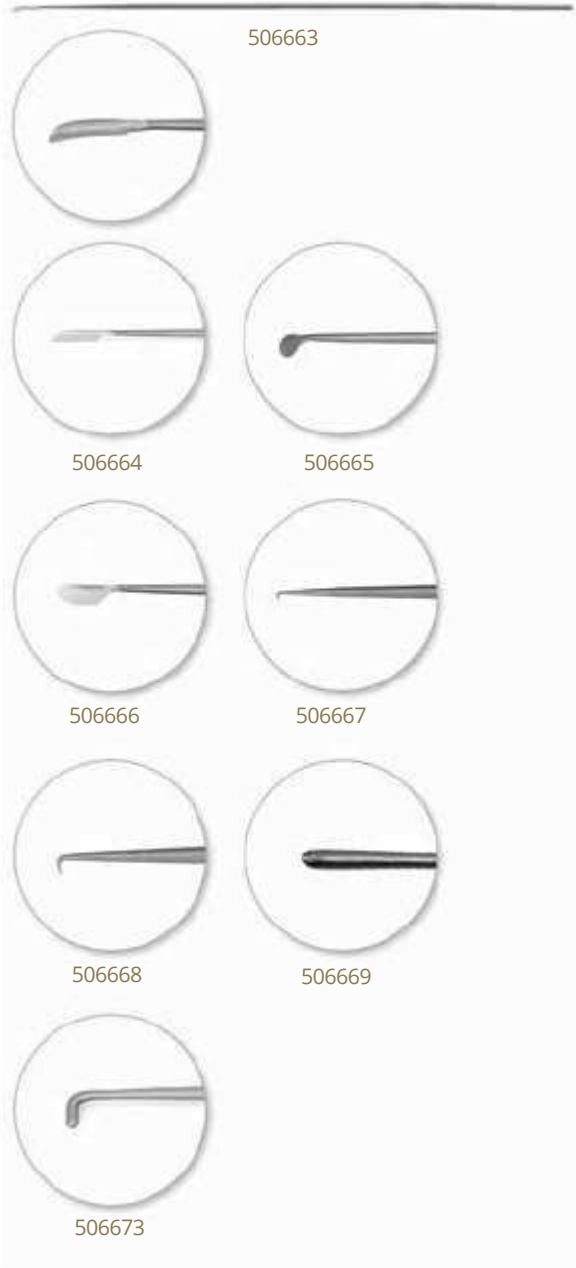

Dull finish to reduce glare. May be used with 506888 Feder-Ossoff Universal Ring Handled Knife Handle (pg. 425). Working length 26 cm.

Catalog #	Description
506663	Jako Sickle Knife, curved
506664	Jako Sickle Knife, straight
506665	Jako Circle Knife
506666	Jako Round Edge Knife
506667	Jako Sharp Hook, slight
506668	Jako Sharp Hook, acute
506669	Jako Probe, straight
506673	Jako Blunt Angled Probe



Shown with probe inserted into handle. Knives and probes can be set to any angle or depth relative to the handle.

INSTRUMENTATION FOR LARYNGOSCOPES

Laser Instrumentation

ANGLED LASER RETRACTORS



509004

For protection of the anterior commissure and the evacuation of smoke and plume during laser surgery. Non-reflective finish on shaft. 23 cm working length.

Catalog #	Description
509004	Adult, right, 8 mm diameter
509005	Adult, left, 8 mm diameter
509006	Pediatric, right, 4 mm diameter
509007	Pediatric, left, 4 mm diameter

LASER SPATULA RETRACTORS



509009

For protection/retraction of the vocal cords and for the evacuation of smoke and plume during laser surgery. 23 cm working length. Non-reflective finish on shaft.

Catalog #	Description
509008	Adult, right, 10 mm diameter
509009	Adult, left, 10 mm diameter
509010	Pediatric, right, 5mm diameter

LASER OPERATING PLATFORM - EBONIZED



509214

The platform is inserted into the subglottic larynx above the level of the packed cottonoids. The platform helps to protect the cottonoids, endotracheal tube and cuff, and tissues of the subglottic larynx from any direct or reflected laser beam radiation. Shaft and tip are ebonized. 21 cm working length.

Catalog #	Description
509214	4 mm diameter platform
509215	6 mm diameter platform
509216	8 mm diameter platform

INSTRUMENTATION FOR LARYNGOSCOPES

Laser Instrumentation

ASPIRATING TUBES



509012

For removal of smoke and steam created during laser surgery. 3 mm diameter (9 Fr.).

Catalog #	Description
509012	"Velvet-eye"-type, working length 7-7/8" (20 cm)
509013	Open end, working length 6" (15 cm)
509014	Clip for attaching aspirating tubes to laryngoscope up to 9 Fr. (3 mm)



509013



509014

INSTRUMENTATION FOR LARYNGOSCOPES

Laser Instrumentation

MICROSUBGLOTTIC INSTRUMENTS

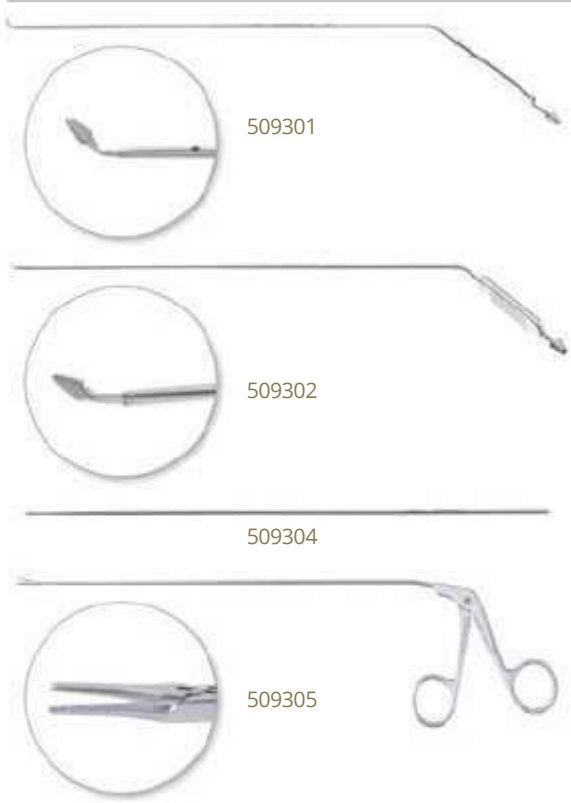



Designed for laser microsurgery of the entire subglottic space and upper cervical trachea, this instrumentation includes forceps, probe, mirror and platform (all 28 cm in length and laser finished).

Catalog #	Description
509301	Operating platform, 3 mm
509302	Front surface mirror, 3 mm
509304	Straight probe
509305	Grasping forceps, straight

INSTRUMENTATION FOR LARYNGOSCOPES

Laser Instrumentation

MICRO-LARYNGEAL PROBES - EBONIZED

	Catalog #	Description
	509205	Straight, ebonized, 10-1/4" (26 cm)
	509206	Angled, ebonized, 10" (25.5 cm)

OSSOFF-KARLAN GRASPING FORCEPS - EBONIZED

	Catalog #	Description
	509201	Curved left, ebonized, working length 8-1/4" (21 cm)
	509202	Curved right, ebonized, working length 8-1/4" (21 cm)
	509203	Straight, ebonized, working length 8-1/4" (21 cm)

OSSOFF-KARLAN MICRO SUCTION TUBE - EBONIZED

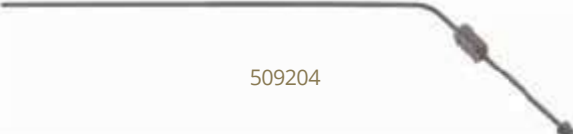
	Catalog #	Description
	509204	7 Fr., ebonized, working length 7-1/2" (19 cm)

INSTRUMENTATION FOR LARYNGOSCOPES

Laser Instrumentation

OSSOFF-KARLAN VOCAL CORD ROLLER - EBONIZED



This instrument was designed to facilitate greater direct exposure of the infraglottic surface of the true vocal cords.

Catalog #	Description
509207	Ebonized, 8-1/4" (21 cm)

Miscellaneous

HOLINGER LARYNGEAL DISSECTOR



Catalog #	Description
506707	12" (30.5 cm)

HOLINGER KNIFE HANDLE



For use with surgical blades no. 10, 11, 12 and 15.

Catalog #	Description
506705	11" (28 cm)

JACKSON STANDARD SPONGE CARRIER



For use through laryngoscopes and bronchoscopes. Heavy construction weight. Stainless steel.

Catalog #	Description
506750	Working length 11-3/4" (30 cm)
506752	Working length 15-3/4" (40 cm)

JAKO FINE SPONGE CARRIER

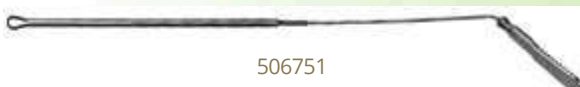

To hold small piece of sponge rubber used to dye vocal cords for diagnostic purposes.

Catalog #	Description
506751	Working length 10-1/4" (26 cm)

INSTRUMENTATION FOR LARYNGOSCOPES

Miscellaneous

ABRAHAM LARYNGEAL SYRINGE CANNULA

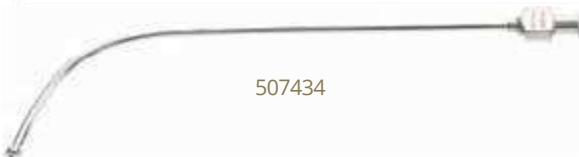

507434

For use on Luer-Lok® syringes.

Catalog #	Description
507434	Malleable, 5-7/8" (15 cm)

BONNIER CATHETER ADAPTER



507335

For attachment of catheters to Luer tip syringes.

Catalog #	Description
507335	1-3/8" (3.5 cm)

LUER-LOK® CATHETER ADAPTER



507336

For attachment of catheters to Luer-Lok® syringes.

Catalog #	Description
507336	1-1/2" (4 cm)

CENTIMETER SUBTRACTION RULER



504075

For accurate calculation by subtraction of the depth to which a scope has been inserted.

Catalog #	Description
504075	30cm

INSTRUMENTATION FOR LARYNGOSCOPES

Miscellaneous

LARYNGEAL MICRO ATOMIZER



507267S



507498S

Permits use of very small quantities of solution. Very fine particle size. Double valve in bulb permits sustained, very effective spray.

Catalog #	Description
507485S	Complete Micro Atomizer (nos. 151 and 1-RD)
507267S	Atomizer glass collection tube, small no. 151
507498S	Atomizer replacement rubber bulb, small no. 1-RD

Laryngeal Mirrors

LARYNGEAL MIRRORS



508204

Extra thin, permanently mounted on handle. Shaft length is 6-3/4" (17 cm).

Catalog #	Description
508200	#000, 8 mm diameter
508201	#00, 10 mm diameter
508202	#0, 12 mm diameter
508203	#1, 16 mm diameter
508204	#2, 18 mm diameter
508205	#3, 20 mm diameter
508206	#4, 22 mm diameter
508207	#5, 24 mm diameter
508208	#6, 28 mm diameter
508209	#7, 30 mm diameter

UROLOGY

UROLOGY

Forceps and Clamps

HERRICK KIDNEY CLAMP



Catalog #
746550

Description
Angled, 41 mm jaw with longitudinal serrations,
9" (23 cm)

RANDALL KIDNEY STONE GRASPING FORCEPS



Catalog #

172650

172655

172660

172665

Description

#1, 1/4" curved, 9-1/4" (23.5 cm)

#2, 1/2" curved, 8-1/4" (21 cm)

#3, 3/4" curved, 7-3/4" (19.5 cm)

#4, Full Curved, 7-3/8" (18.5 cm)

UROLOGY

Forceps and Clamps

MAYO VESSEL CLAMP



Catalog #
243110

Description
Curved, 1-1/2" (4 cm) tip length, 10" (25.5 cm)

243110

MCDUGAL™ PROSTATECTOMY CLAMPS



Secures the dorsal vein complex during radical retropubic prostatectomy. Useful for other deep retropubic or deep pelvic work when approached from the abdomen. Allows easy access in operative site obstructed by the pubis or other structures.

Catalog #
242005
242006

Description
Angled left, 1" (2.5 cm) tip length, 9-7/8" (25 cm)
Angled right, 1" (2.5 cm) tip length, 9-7/8" (25 cm)

242005

UROLOGY

Forceps and Clamps

VASECTOMY CLAMP



Catalog #
244001

Description
No scalpel ring clamp, 3.6 mm ring I.D.,
5-1/2" (14 cm)

VASECTOMY FORCEPS



Catalog #
244000

Description
No scalpel hemostat, 19 Ga. tip, sharp,
5-1/8" (13 cm)

UROLOGY

Forceps and Clamps

ZIPSER PENIS CLAMP

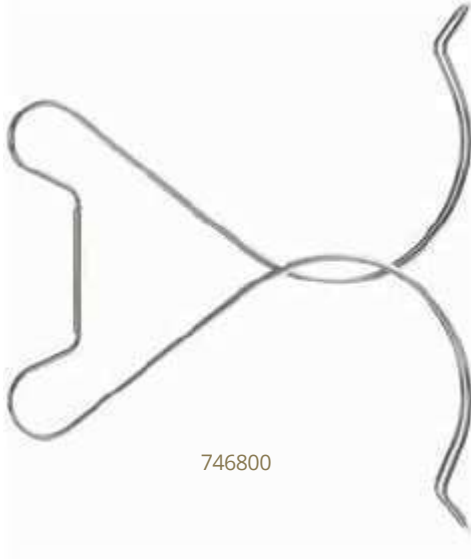

Catalog #
746800

Description
3-3/8" (8.5 cm)

Dilators, Sounds and Needles

DITTEL URETHRAL SOUNDS



11-1/2" (29 cm). 1 Fr. = 0.33 mm.

Catalog #	Description
GS64008	8 Fr., 11-1/2" (29 cm)
GS64010	10 Fr., 11-1/2" (29 cm)
GS64012	12 Fr., 11-1/2" (29 cm)
GS64014	14 Fr., 11-1/2" (29 cm)
GS64016	16 Fr., 11-1/2" (29 cm)
GS64018	18 Fr., 11-1/2" (29 cm)
GS64020	20 Fr., 11-1/2" (29 cm)
GS64022	22 Fr., 11-1/2" (29 cm)
GS64024	24 Fr., 11-1/2" (29 cm)
GS64026	26 Fr., 11-1/2" (29 cm)
GS64028	28 Fr., 11-1/2" (29 cm)
GS64030	30 Fr., 11-1/2" (29 cm)
GS64032	32 Fr., 11-1/2" (29 cm)
GS64034	34 Fr., 11-1/2" (29 cm)

UROLOGY

Dilators, Sounds and Needles

VAN BUREN URETHRAL DILATORS

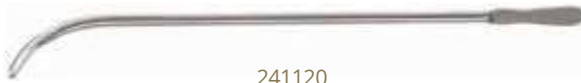

241120

10-7/8" (27.5 cm), even sizes, 8 Fr. to 32 Fr.

Catalog #	Description
241108	8Fr.
241110	10 Fr.
241112	12 Fr.
241114	14 Fr.
241116	16 Fr.
241118	18 Fr.
241120	20 Fr.
241122	22 Fr.
241124	24 Fr.
241126	26 Fr.
241128	28 Fr.
241130	30 Fr.
241132	32 Fr.

LITVAK PEREYRA LIGATURE NEEDLE

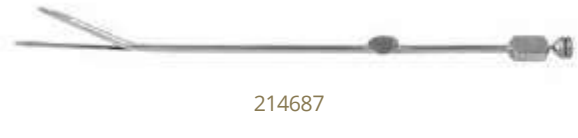

214687

Catalog #	Description
214687	9-7/8" (25 cm)

STAMEY NEEDLES



214688

Used in conjunction with the treatment of urinary incontinence in the female.

Catalog #	Description
214688	Straight, 9-3/4" (25 cm)
214689	Angled 15 degrees, 9-3/4" (25 cm)
214691	Angled 30 degrees, 9-3/4" (25 cm)

UROLOGY

Catheter Guides

FEMALE CATHETER SILVERS



740166

Catalog #
740165
740166

Description
14 Fr., 5-7/8" (15 cm)
16 Fr., 5-7/8" (15 cm)

GUYON CATHETER GUIDE

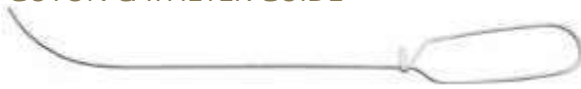

746797

Catalog #
746797

Description
9 Fr., 13-1/4" (33.5 cm)

VAN BUREN CATHETER GUIDE



746798

Catalog #
746798

Description
9 Fr., 13-3/4" (35 cm)

Retractors

LOWSLEY PROSTATIC RETRACTORS



243200

Catalog #
243200
243201

Description
Curved, 9-1/2" (24 cm)
Straight, 12-7/8" (32.5 cm)

VALVE INSTRUMENTS

VALVE INSTRUMENTS

Valve Retractors

COOLEY MITRAL VALVE RETRACTORS

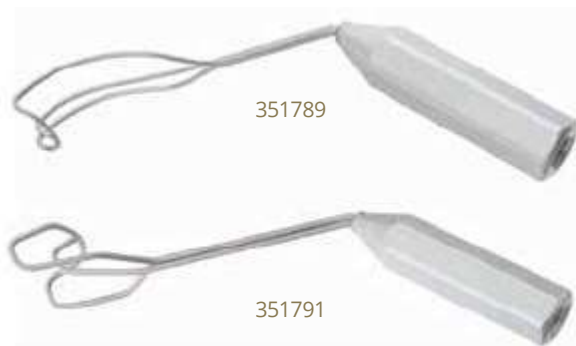

Designed to provide optimum exposure of the mitral valve, particularly for complete valve replacement. The wire frame blades are shaped to help solve exposure problems in the approach from a right or left thoracotomy and are therefore available as Right and Left Retractors.

Catalog #	Description
351788	Right, small blade width 7/8" (2 cm), depth 1/2" (1.5 cm), overall length 7-1/4" (18.5 cm)
351789	Right, medium blade width 1-3/8" (3.5 cm), depth 3/4" (2 cm), overall length 7-1/2" (19 cm)
351790	Right, large blade width 1-7/8" (4.5 cm), depth 1-3/8" (3.5 cm), overall length 7-3/8" (19 cm)
351791	Left, large blade width 1-7/8" (4.5 cm), depth 3/8" (1 cm), overall length 8-7/8" (22.5 cm)

PEDIATRIC UNIVERSAL CLAMPS



341531

Catalog #	Description
341531	Set of 2

CRAWFORD AORTIC RETRACTORS



351774

To retract aortic incision exposing aortic valve in replacement operation. Incision is made about an inch beyond the heart, about halfway around the circumference of the aorta. This retractor retracts the lower lip, exposing the valve.

Catalog #	Description
351773	Small, blade 15 mm wide x 20 mm deep, 7-3/8" (18.5 cm)
351774	Large, blade 22 mm wide x 20 mm deep, 7-7/8" (20 cm)

VALVE INSTRUMENTS

Valve Retractors

DESMARRES VALVE RETRACTORS



351769

Lightweight blades of various sizes constructed of Beryllium Copper. Shafts are semi-malleable. Length 7-1/4" (18.5 cm).

Catalog #	Description
351767	Width 4 mm
351768	Width 6 mm
351769	Width 8 mm
351770	Width 10 mm
351771	Width 12 mm
351772	Width 15 mm

MORSE VALVE RETRACTOR



351780

Cushing-shaped blades 12 mm deep.

Catalog #	Description
351780	Blade 1-5/8" (42 mm) wide, 8-1/2" (21.5 cm)

REVUELTA GARCIA VALVE LEAFLET RETRACTOR



351747

Catalog #	Description
351747	8" (20.5 cm) working length

VALVE INSTRUMENTS

Valve Retractors

LEMOLE- VALVE RETRACTOR



341506



341511



341512



341513



341520



341522



341523

Provides self-retaining valve retraction. Fits directly onto arms of many types of sternal retractors. The T-Frame cross bar attaches to the sternal retractor by means of a "C" clamp. 8" (20.3 cm) T-Frame cross bar allows for addition of valve retractor blades without removing previously placed blades, using universal clamps. Set includes 6 valve retracting blades and 2 universal clamps. Various size blades available for any size atrium.

Catalog #	Description	Qty.
341501	Lemole- Valve Retractor <u>Set #1 Fits Cooley and Chaux Sternal Retractors</u>	
341502	Lemole- Valve Retractor Set #2 Fits Morse-style Retractors	
341503	Lemole- Valve Retractor Set #3 Fits Ankeney Retractor	
341506	Lemole- Valve Retractor Set #1 with Cooley Retractor (341195)	
341511	Lemole- T-Frame #1 only	
341512	Lemole- T-Frame #2 only	
341513	Lemole- T-Frame #3 only	
	CoMplete set inCluDes	
341520	Universal Clamp for Lemole	2
341522	Cooley Atrial Retractor, small, 9-1/2" (24 cm)	2
341523	Cooley Atrial Retractor, medium, 9-1/2" (24 cm)	1
341524	Cooley Atrial Retractor, large, 9-1/2" (24 cm)	1
341525	Malleable Atrial Retractor, 8-3/4" (22 cm)	2
341511, 341512, or 341513	T-Frame only for type #1, #2 and #3	1

VALVE INSTRUMENTS

Valve Retractors

CHAUX-LEMOLE BI-ANGLE T-FRAME



341514

Bi-Angle T-Frame, for additional third point atrial retraction during mitral valve surgery, fits Cooley-style and Chaux Retractors.

Catalog #	Description
341514	Arm tip maximum diameter 0.252", overall width 9-7/8" (25 cm)

LEMOLE SELF RETAINING ATRIAL RETRACTOR



351783

Designed to eliminate the need for an assistant when retracting the left atrium during mitral valve repair or replacement. Will attach to most standard chest retractors.

Catalog #	Description
351783	10-1/2" (26.5 cm)

VALVE INSTRUMENTS

Valve Retractors

LEMOLE SIDE ARM EXTENSION



341515

Catalog #
341515

Description
For third point atrial retraction during mitral valve surgery, fits Cooley-style and Chaux Retractors.

ABLAZA-BLANCO CARDIAC VALVE RETRACTOR



351763

Notched to prevent slippage in use.

Catalog #
351763

Description
Angulated, blade 9/16" (1.5 cm) wide, 13" (33 cm)

BLANCO VALVE INSTRUMENTS

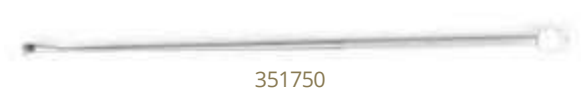

351750



351752



351754



351755

Long, slender shaft retractors with small, thin blades specially made for use on heart valves. The "spreader" is a fenestrated retractor designed to allow the insertion of the scissors blades. All have a finger rest on a knurled handle. Working length of shaft is 7-1/16" (18 cm).

Catalog #

Description

351750

Blanco Retractor, blade 5 mm wide x 7 mm deep, 11-1/2" (29 cm)

351752

Blanco Retractor, blade 7 mm wide x 7 mm deep, 11" (28 cm)

351754

Blanco Retractor, Cushing type, blade 12 mm wide x 7 mm deep, 11" (28 cm)

351755

Blanco Valve Spreader, blade 9 mm wide x 10 mm deep, 11-1/2" (29 cm)

VALVE INSTRUMENTS

Suture Rings

CRAWFORD SUTURE RING



352598

Affords a convenient method of retaining sutures in mitral and aortic valve replacement.

Catalog #	Description
352598	Diameter 10" (25.5 cm)

GRUNWALD SUTURE GUIDE HOLDER



342015

The Grunwald Suture Guide Holder, when used with the Gabbay-Frater™ Suture Guides (pg. 1158), affords a convenient method of keeping numerous sutures properly aligned during cardiac valve replacement procedures. The holder can be positioned directly over the sternotomy retractor. Three spring clips on the underside of the holder secure it to the surgical drapes. Three sterile, disposable Gabbay-Frater™ Suture Guides may be placed on the retaining posts of the holder either before or after placement of the holder over the sternotomy. The Grunwald Holder provides a flat, constant and secure surface for the suture guides and speeds placement by eliminating the need for using numerous towel clips that can also tend to clutter the operative field. The Grunwald Suture Guide Holder is made of stainless steel and may be steam autoclaved.

Catalog #	Description
342015	13-1/4" (33.5 cm)

VALVE INSTRUMENTS

Aortic Valve Rongeurs

BAILEY AORTIC VALVE RONGEURS



These instruments were designed for the removal of calcified material from the stenotic aortic valve. They have also proven useful in peripheral vascular surgery for trimming stenotic arteries and plaque removal. They are in six styles but all have the same 3.5 mm wide-bite. Working length 5-1/8" (13 cm).

Catalog #	Description
352800	Straight biting
352802	Slight downward angle (25 degrees)
352804	Acute downward angle (70 degrees)
352806	Right downward angle (90 degrees)
352808	Angled to left side (45 degrees)
352810	Angled to right side (45 degrees)

VALVE INSTRUMENTS

Valve Hooks

CARDIAC VALVE HOOK, CALIBRATED

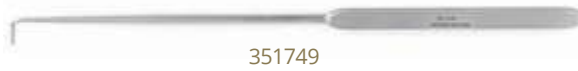

351749

Catalog #
351749

Description
9-3/4" (24.5 cm), 10 mm hook

COARCTATION HOOK



355175

Stainless steel.

Catalog #
355175

Description
Right angle bend, blunt tip, 7 mm hook,
10-1/8" (25.5 cm)

DEBAKEY VALVE HOOK



351785

Slender shaft, sharp-pointed hooks used to aid in manipulation of valves in replacement operations.

Catalog #
351785

Description
3/8" (8.5 mm) hook, 12-1/2" (31.5 cm)

VALVE INSTRUMENTS

Valve Hooks

MICRO VASCULAR NERVE HOOK



357532

Catalog #
357532

Description
Micro hook, small, 7-1/4" (18.5 cm)

SISSON NERVE HOOK



060120

Catalog #
060120

Description
90 degree angled, blunt, 6 mm hook,
6-1/8" (15.5 cm)

REVUELTA-GARCIA VALVE MIRROR



351737

Catalog #
351737

Description
9" (23 cm)

VALVE INSTRUMENTS

Valve Dilators

GERBODE VALVE DILATOR



For retrograde fracture of the mitral valve through a small incision in the apex of the left ventricle. It has a regulating screw so that the mitral valve can be gradually fractured. May also be used for fracture of the aortic and pulmonary valves.

Catalog #	Description
352615	Blades adjustable, opening to 1-3/4" (4.5 cm) wide

TUBBS VALVE DILATOR



Catalog #	Description
352630	Maximum blade opening 1-3/4" (4.5 cm) wide

VIDEO- ASSISTED

VIDEO-ASSISTED THORACOSCOPY

Landreneau Design

PENNINGTON GRASPING FORCEPS



131114A

Catalog#
131114A

Description
10.2 mm tip width, 10 mm shaft diameter, 13 cm shaft length, locking, 7-7/8" (20 cm) working length

STRAIGHT MASHER GRASPING FORCEPS



211116A

Catalog#
211116A

Description
Thin, teardrop-shaped, 10 mm diameter, 21 cm shaft length, locking, 7.8 mm tip width, 11-3/4" (30 cm) working length

CURVED MASHER GRASPING FORCEPS



211117A

Catalog#
211117A

Description
Thin, teardrop-shaped, tip curved 20 degrees, 7.8 mm tip width, 21 cm shaft length, locking

VIDEO-ASSISTED THORACOSCOPY

Landreneau Design

STRAIGHT MASHER GRASPING FORCEPS



Catalog #
211118A

Description
Round, 13.8 mm tip width, 21 cm shaft length,
locking, 11-3/4" (30 cm) working length

STRAIGHT DEBAKEY GRASPING FORCEPS



Catalog #
211603A

Description
10 mm diameter, 7 mm tip width, 21 cm shaft length,
locking, 11-3/4" (30 cm) working length

LAWRENCE FINE DISSECTING FORCEPS



Catalog #
211245A

Description
45 degree curved tip, 21 cm shaft length, locking,
9-7/8" (25 cm) working length, overall length 15-3/8"
(39 cm)

VIDEO-ASSISTED THORACOSCOPY

Landreneau Design

MEEKER DISSECTING FORCEPS



Catalog #
211290A

Description
90 degree curved, 2.7 mm tip width, 21 cm shaft length, locking, 9-3/4" (24.5 cm) working length

211290A

METZENBAUM SCISSORS CURVED



Catalog #
211325A

Description
1.7 mm tip width, 10 mm diameter shaft, 21 cm shaft length, non-locking, 9-1/2" (24 cm) working length

211325A

STRAIGHT SINGLE ACTION NEEDLE HOLDER



Catalog #
215558A

Description
5 mm diameter shaft, 21 cm shaft length, locking, 8-7/8" (23 cm) working length

215558A

VIDEO-ASSISTED THORACOSCOPY

Landreneau Design

LANDRENEAU THORACOSCOPY TRAY



211500

Catalog #
211500

Description
20-3/4" (52.5 cm) x 9-7/8" (25 cm)

LANDRENEAU THORACOSCOPY SET



211600

Catalog #
211600

Description
Complete set. Includes all catalog codes in the Landreneau Design section (except 341310, the optional Heitmiller Mini Thoracotomy Retractor)

KAISER- INSTRUMENTS

Instruments designed specifically for thoracoscopy that deliver the versatility you require and the feel to which you are accustomed.

Unique instruments with a "No Cannula" technique provide you with a versatility not found before in thoracoscopy procedures.

Elimination of cannulas allows for the use of traditional patterns of instruments that have been elongated and shaped to meet the special needs of the thoracoscopist. These new-dimensioned instruments provide you with the familiar feel,

weight and balance to which you are accustomed. This means you can rely on the practiced hand movements used in open procedures. The accessories extend your "reach" even farther.

Other advantages of the "No Cannula" procedure using these instruments are:

- Reduced patient costs since fewer cannulas are required
- Palpation of lesions is permitted
- Number of incisions is minimized as instrument length and shape permit access to all areas of the thoracic cavity

Catalog #	Description
841000	Complete set includes: 166868, 841010, 841011, 841012, 841013, 841030, 841031, 841032, 841033, 841050, 841051, 841052, 841100, 841101, 841300, 841301, 841350, 841351, 841400, 841951 Lahey instrument holder
166868	instrument holder
841010	Ring forceps (1L)
841011	Ring forceps (2L)
841012	Ring forceps (4L)
841013	Ring forceps (3L)
841030	Ring forceps (1S)
841031	Ring forceps (2S)
841032	Ring forceps (4S)
841033	Ring forceps (3S)
841050	Atraugrip ring forceps (1AG)
841051	Atraugrip ring forceps (5AG)
841052	Atraugrip ring forceps (2AG)
841100	Biopsy forceps, malleable
841101	Biopsy forceps, rigid
841300	Spatula, slightly curved
841301	Spatula, acute curved
841350	Yankauer suction tube
841351	Andrews suction tube
841400	Hook, blunt
841951	2 tier storage tray

VIDEO-ASSISTED THORACOSCOPY

Kaiser- Design

KAISER- SHORT JAW RING FORCEPS



1 x 11 ratchets, 3-3/8" (8.5 cm) jaw.

Catalog #	Description
841030	Straight (1S), 12-5/8" (32 cm)
841031	Curved (2S), 12-1/8" (31 cm)
841032	C-shaped (4S), 10-7/8" (28 cm)
841033	Curved on side (3S), 12" (30.5 cm)
841034	Curved handle, 11-7/8" (30 cm)

VIDEO-ASSISTED THORACOSCOPY

Kaiser- Design

KAISER- LONG JAW RING FORCEPS

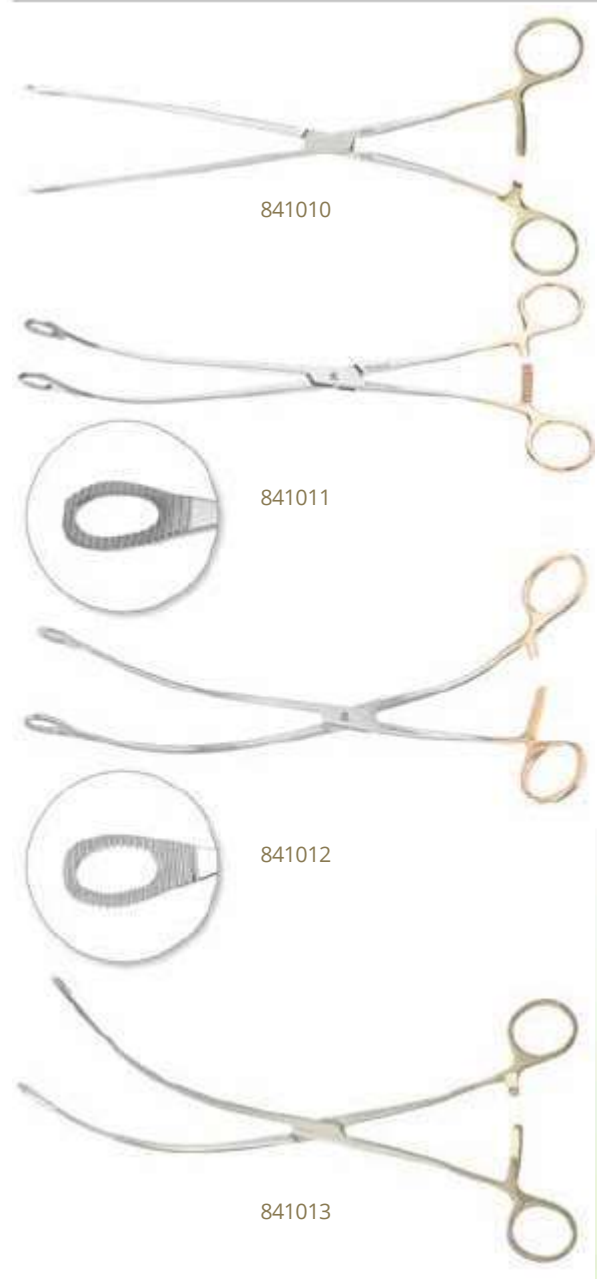

1 x 11 ratchets, 6-3/8" (16 cm) jaw.

Catalog#	Description
841010	Straight (1L), 6-3/8" (16 cm) jaw, 12-5/8" (32 cm)
841011	Curved (2L), 6-3/8" (16 cm) jaw, 12-1/4" (31 cm)
841012	"C" shaped (4L), 6-3/8" (16 cm) jaw, 10-7/8" (28 cm)
841013	Curved on side (3L), 12-1/8" (31 cm)
841014	Curved handle, 12-1/8" (31 cm)
841015	90 degree ring jaw, 11-7/8" (30 cm)
841016	45 degree ring jaw, 12-1/4" (31 cm)



VIDEO-ASSISTED THORACOSCOPY

Kaiser- Design

KAISER- THORACOSCOPIC FORCEPS



Catalog #
841160
841161

Description
Straight, without ratchets, 12" (31 cm)
Slight curve, without ratchets, 11-3/4" (30 cm)

VIDEO-ASSISTED THORACOSCOPY

Kaiser- Design

KAISER- DEBAKEY®-TYPE RING FORCEPS



1 x 11 ratchets.

Catalog #	Description
841050	Straight (1AG), 12-5/8" (32 cm)
841051	"S"-shaped (5AG), 11-3/4" (30 cm)
841052	Curved jaw (2AG), 12-1/4" (31 cm)

KAISER- DEBAKEY®-TYPE ALLIS RING FORCEPS



Catalog #	Description
841150	2 x 3 DeBaKey®-type Jaws, 21 mm, 12" (31 cm)

VIDEO-ASSISTED THORACOSCOPY

Kaiser- Design

KAISER- BIOPSY FORCEPS



Catalog #	Description
841100	Malleable, 4 mm cup, 12-5/8" (32 cm)
841101	Rigid, slightly curved, 4 mm cup, 11" (28 cm)

KAISER- ANGLE SICKLE KNIFE



Catalog #	Description
841330	Sharp tip, 13" length (33 cm)

KAISER- BLUNT HOOK

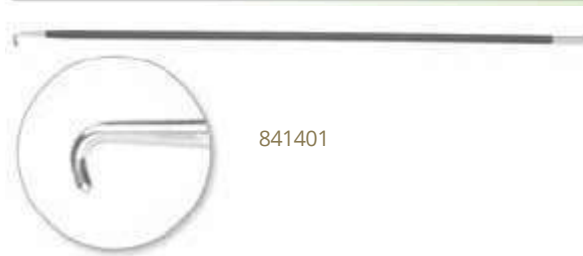

Catalog #	Description
841401	Insulated, 13" (33 cm)

VIDEO-ASSISTED THORACOSCOPY

Kaiser- Design

KAISER- SPATULA

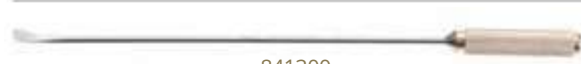

14" (35.5 cm).

841300

Catalog #	Description
841300	Slight curve
841301	Acute curve
841302	Straight



841300



841301

KAISER- ANDREWS SUCTION



Catalog #	Description
841351	11-3/4" (30 cm)

841351

KAISER- HOOK



Catalog #	Description
841400	Blunt, 13" (33 cm)

841400

VIDEO-ASSISTED THORACOSCOPY

Kaiser-Design

KAISER- SUCTION WITH THUMB VALVE



841350

Catalog #
841350

Description
13-1/4" (33.5 cm)

KAISER- TRAY

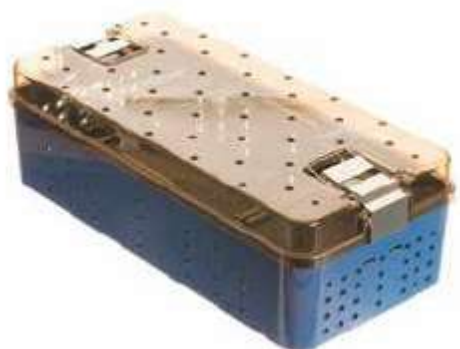

841951

Catalog #
841951

Description
20-3/4" length x 10" width x 4-5/8" height
(52.5 x 25.5 x 11.5 cm)

DISSECTORS AND ELEVATORS

DISSECTORS AND ELEVATORS

SMITHWICK HOOK AND DISSECTOR



GS49320

Catalog #	Description
GS49320	Double-ended, 12" (30.5 cm)

WOODSON DURAL SEPARATOR AND PACKER



GS55302

Catalog #	Description
GS55302	Double-ended with grooved blade, 3 mm blunt end, 7" (18 cm)

WOODSON ELEVATOR AND SPATULA

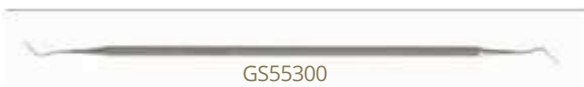

GS55300

Catalog #	Description
GS55300	Double-end, semi-sharp, angled, both ends 3 mm, 10" (25.5 cm)

RHOTON BALL-TIPPED DISSECTORS



GS55346

7-1/2" (19 cm).

Catalog #	Description
GS55344	Straight, 0.8 mm
GS55345	Angled 90 degrees, 3 mm
GS55346	Angled 90 degrees, 5 mm
GS55347	Angled 40 degrees, 4 mm
GS55348	Angled 40 degrees, 8 mm

RHOTON ELEVATORS



GS55333

7-1/2" (19 cm).

Catalog #	Description
GS55333	Curved
GS55334	Angled

DISSECTORS AND ELEVATORS

ORTHOPEDIC INSTRUMENTS

RHOTON MICRO CURETTES



7-1/2" (19 cm).

Catalog #	Description
GS55342	Straight, 1 x 2 mm
GS55343	Angled, 1 x 2 mm

RHOTON MICRO DISSECTION HOOKS



Catalog #	Description
GS55338	Sharp, angled 90 degrees
GS55339	Blunt, angled 90 degrees
GS55340	Sharp, angled 45 degrees

RHOTON NEEDLE SHARP



Catalog #	Description
GS55341	Straight, sharp

DISSECTORS AND ELEVATORS

RHOTON ROUND DISSECTORS



Catalog #	Description
GS55330	Angled, 1 mm
GS55331	Angled, 2 mm
GS55332	Angled, 3 mm

RHOTON SPATULA DISSECTORS



Catalog #	Description
GS55335	#6 Small, angled
GS55336	#7 Medium, angled
GS55337	#8 Large, angled

DISSECTORS AND ELEVATORS

Penfield Elevators/Dissectors

ORTHOPEDIC INSTRUMENTS

PENFIELD ELEVATORS



GS57624

Catalog #
 GS57624
 GS57626
 GS57628
 GS57630
 GS57632

Description
 Style #1, double-ended, 7" (18 cm)
 Style #2, double-ended, 7-3/4" (19.5 cm)
 Style #3, double-ended, 7-3/4" (19.5 cm)
 Style #4, single-ended, 8" (20.5 cm)
 Style #5, double-ended, 7-1/2" (19 cm)



GS57626



GS57628



GS57630



GS57632

DISSECTORS AND ELEVATORS

Double-Ended Elevators

ALLERDYCE ELEVATOR AND DISSECTOR



GS57616

Catalog #
GS57616Description
Double-ended, 8 mm semi-sharp end, 8 mm blunt
end, 7-1/2" (19 cm)

FREER DOUBLE-END ELEVATOR



355194

Pattern, satin finish.

Catalog #
355194Description
Double-ended, sharp and blunt, 7" (18 cm)

FREER DOUBLE-END ELEVATOR



GS57614

Pattern, satin finish.

Catalog #
GS57614Description
Double-ended, 5 mm sharp and 5 mm blunt ends,
7-1/4" (18.5 cm)

KLEINERT-KUTZ ELEVATOR AND DISSECTOR



GS57615

Catalog #

GS57615

Description
Double-ended, 2 mm and 3 mm sharp ends,
7-5/8" (19.5 cm)

KLEINERT-KUTZ ELEVATOR AND DISSECTOR



065300

Catalog #

Description
Double-ended, 2.4 mm and 3.2 mm ends,
7-3/4" (19.5 cm)

DISSECTORS AND ELEVATORS

Metatarsal Elevators

ORTHOPEDIC INSTRUMENTS

MCGLAMERY® METATARSAL ELEVATOR



GS69758

Catalog #	Description
GS69758	Sharp, curved, 9 mm, 6-1/2" (16.5 cm)

MCGLAMERY® METATARSAL ELEVATORS



GS69764

For foot surgeons, the McGlamry® Elevator is indispensable. It's the perfect tool to deglove a metatarsal head, and it's invaluable in numerous other procedures. Sharp edge, 6-1/2" (16.5 cm).



Catalog #	Description
GS69760	11mm
GS69762	13mm
GS69764	15mm
GS69766	17mm



GS69760



GS69762



GS69764



GS69766

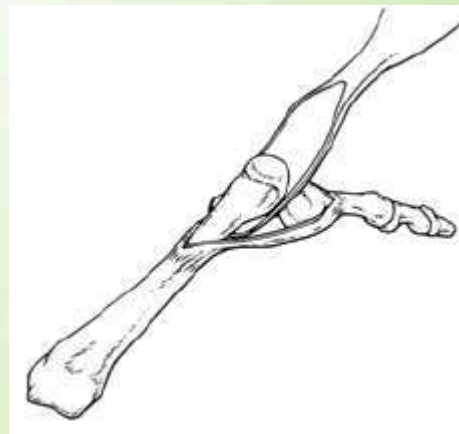

DISSECTORS AND ELEVATORS

Periosteal Elevators

COTTLE DOUBLE-ENDED ELEVATOR

A



053135

B

Graduated in 10 mm increments.

Catalog #

053135

Description

Blade A 5 mm

Blade B 3 mm

8-7/8" (22.5 cm)

MCKENTY ELEVATORS



GS57620

Semi-sharp, 5-1/2" (14 cm).

Catalog #

GS57620

GS57622

Description

4mm

5mm

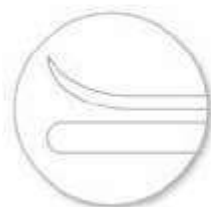

GS57620



GS57622

DISSECTORS AND ELEVATORS

Periosteal Elevators

ORTHOPEDIC INSTRUMENTS

KEY PERIOSTEAL ELEVATORS



GS46262

Sharp edge.

Catalog #	Description
GS46258	1/4" (6.4 mm) wide, 7" (17.5 cm)
GS46260	3/8" (9.5 mm) wide, 7-1/2" (19 cm)
GS46262	1/2" (13 mm) wide, 7-1/2" (19 cm)
GS46264	3/4" (19 mm) wide, 7-7/8" (20 cm)
GS46266	1" (25.4 mm) wide, 8-3/8" (21.5 cm)

KEY PERIOSTEAL ELEVATOR



Catalog #	Description
586250	1/8" (3 mm) jaw, 7" (18 cm)



586250

ADSON PERIOSTEAL ELEVATORS



GS49310

Also known as Joseph Elevator, 7 mm, 6-3/4" (17 cm).

Catalog #	Description
GS49310	Sharp, straight
GS49311	Blunt, curved
GS49313	Semi-sharp, straight
GS49312	Semi-sharp, curved



GS49310



GS49311



GS49313



GS49312

DISSECTORS AND ELEVATORS

Periosteal Elevators

CUSHING LITTLE JOKER ELEVATOR



358350

Catalog #
358350

Description
8 mm tip, 6-5/8" (16.5 cm)

CUSHING PERIOSTEAL ELEVATORS



GS49322

7-1/2" (19 cm).

Catalog #
GS49322
GS49324
GS49326

Description
15 mm sharp, curved edge
15 mm sharp, straight edge
15 mm serrated, curved edge



GS49322

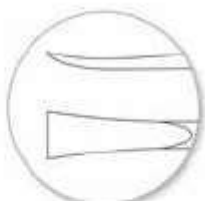

GS49324



GS49326

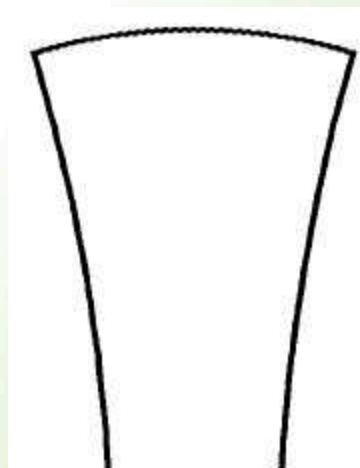

GS49326

DISSECTORS AND ELEVATORS

Periosteal Elevators

ORTHOPEDIC INSTRUMENTS

REGO PERIOSTEAL ELEVATOR

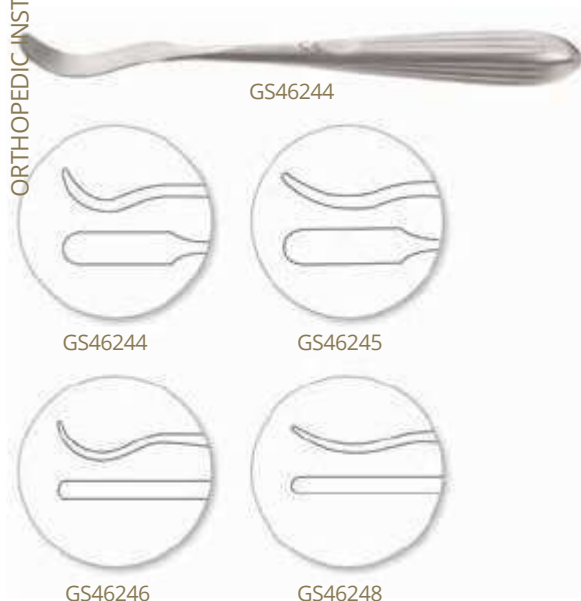

Catalog #	Description
GS46244	Blunt, full curved, 15 mm, 7-3/8" (18.5 cm)
GS46245	Sharp, slightly curved, 15 mm, 7-3/4" (19.5 cm)
GS46246	Sharp, full curved, 7 mm, 7-3/4" (19.5 cm)
GS46248	Sharp, slightly curved, 7 mm, 8" (20.5 cm)

LANE PERIOSTEAL ELEVATOR



Blunt, 7-3/4" (19.5 cm).

Catalog #	Description
GS46208	Narrow, 6 mm
GS46210	Broad, 10 mm

LANGENBECK PERIOSTEAL ELEVATOR



7-3/4" (19.5 cm)

Catalog #	Description
GS46222	Narrow, 6 mm, blunt edge
GS46224	Broad, 17 mm, sharp edge

DISSECTORS AND ELEVATORS

Periosteal Elevators

SEDILLOT PERIOSTEAL ELEVATOR



GS58085

Catalog #
GS58085

Description
16 mm, 7" (18 cm)

SAYRE PERIOSTEAL ELEVATOR



586240

Catalog #
586240

Description
Double-ended, 4 mm straight blunt end,
8 mm curved sharp end, 6-5/8" (17 cm)

SAYRE PERIOSTEAL ELEVATOR

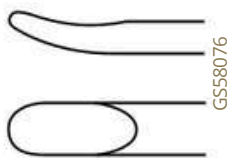

GS58076

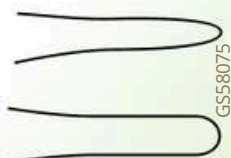

GS58075

Catalog #
GS58075

Description
Double-ended, 5 mm sharp end, 9 mm sharp end,
6-1/2" (16.5 cm)

GS58076

Description
Double-ended, 5 mm blunt end, 9 mm blunt end,
6-1/2" (16.5 cm)

DISSECTORS AND ELEVATORS

Periosteal Elevators

ORTHOPEDIC INSTRUMENTS

PERIOSTEAL ELEVATOR



GS46211

Phenolic handle, 7-1/2" (19 cm).

Catalog #	Description
GS46206	Sharp, curved blade, 3 mm straight edge
GS46207	Sharp, curved blade, 6 mm straight edge
GS46211	Sharp, straight blade, 6 mm straight edge
GS46212	Sharp, curved blade, 6 mm round edge

Autoclavable to 290°F (143°C)



GS46211

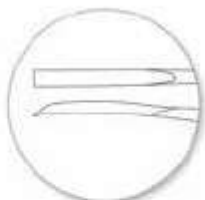

GS46206

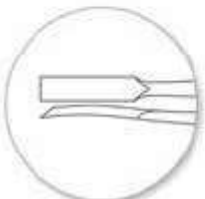

GS46207



GS46212

PERIOSTEAL ELEVATOR



GS46213

Phenolic handle.

Catalog #	Description
GS46213	Sharp, straight blade, 14 mm oval edge, 7-7/8" (20 cm)
GS46214	Sharp, curved blade, 14 mm oval edge, 7-5/8" (19.5 cm)

Autoclavable to 290°F (143°C)



GS46213



GS46214

DISSECTORS AND ELEVATORS

Periosteal Elevators

PERIOSTEAL ELEVATOR

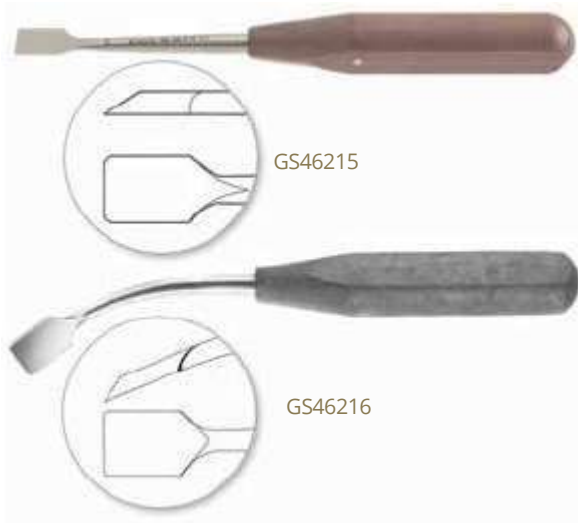

Phenolic handle.

Catalog #	Description
GS46215	Sharp, straight blade, 13 mm straight edge, 7-1/4" (18.5 cm)
GS46216	Sharp, curved blade, 13 mm straight edge, 7-5/8" (19.5 cm)
GS46217	Sharp, straight blade, 20 mm round edge, 7-7/8" (20 cm)

Autoclavable to 290°F (143°C)



Cobb Elevators

COBB SPINAL ELEVATORS, HEX HANDLE



All stainless steel and hexagonal handle.
Sharp, 9-1/2" (24 cm).

Catalog #	tip Width
GS49340	1/2" (13 mm)
GS49342	3/4" (19 mm)
GS49344	1" (25.5 mm)
GS49346	1-1/4" (32 mm)

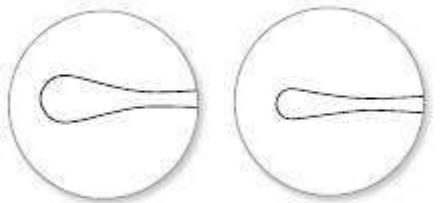

GS49342

GS49340

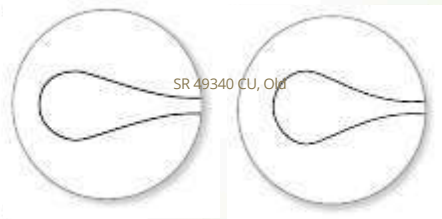

GS49344

GS49346

DISSECTORS AND ELEVATORS

Cobb Elevators

ORTHOPEDIC INSTRUMENTS

COBB SPINAL ELEVATORS, ALUMINUM HANDLE



GS46414

All stainless steel working end and anodized aluminum handle. Sharp, 11" (28 cm).

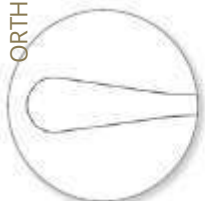

GS46414

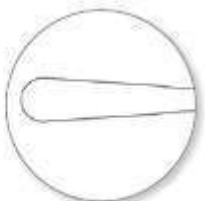

GS46413

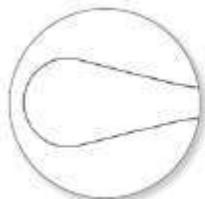

GS46416

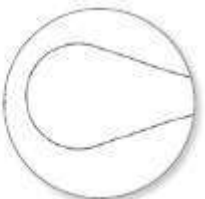

GS46418



GS46420

Catalog #	tip Width
GS46413	3/8" (10 mm)
GS46414	1/2" (12 mm)
GS46416	3/4" (19 mm)
GS46418	1" (25 mm)
GS46420	1-1/4" (32 mm)

DISSECTORS AND ELEVATORS

Cobb Elevators

COBB SPINAL ELEVATORS, STAINLESS STEEL HANDLE



GS46414S

All stainless steel working end and handle.
Sharp, 11" (28 cm).

Catalog #	tip Width
GS46413S	3/8" (10 mm)
GS46414S	1/2" (12 mm)
GS46416S	3/4" (19 mm)
GS46418S	1" (25 mm)
GS46420S	1-1/4" (32 mm)



GS46414S

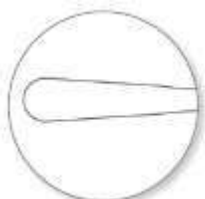

GS46413S

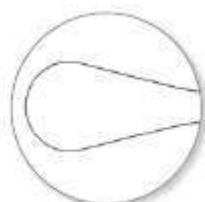

GS46416S



GS46418S



GS46420S

Endoscopic Elevators

ENDOSCOPIC COBB ELEVATORS



GS55614

Phenolic handle.



GS55614

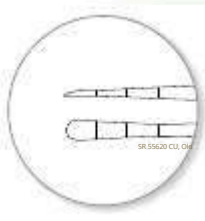

GS55620



GS55610



GS55612

Catalog #	tip Width	tip length	shaft length	shaft Diameter	handle length	overall length
GS55620	1/4" (6 mm)	2.7"	9.3"	0.285" (7.2 mm)	5"	17" (43 cm)
GS55610	1/4" (6 mm)	3-1/2"	10"	0.45" (11.5 mm)	6-1/2"	20" (51 cm)
GS55612	3/8" (10 mm)	3-1/2"	10"	0.45" (11.5 mm)	6-1/2"	20" (51 cm)
GS55614	0.49" (12.5 mm)	3-1/2"	10"	0.45" (11.5 mm)	6-1/2"	20" (51 cm)

Phenolic handles autoclavable to 290°F (143°C)

DISSECTORS AND ELEVATORS

Endoscopic Elevators

ORTHOPEDIC INSTRUMENTS

ENDOSCOPIC RIB ELEVATORS



Sharp, with phenolic handle.

Catalog #	tip shape	tip width	tip length	shaft length	shaft Diameter	handle length	overall length
GS55640	Angled 45 degrees	9 mm radius	4"	8"	0.45" (11.5 mm)	5"	17" (43 cm)
GS55644	Curved 90 degrees	9 mm radius	4"	8"	0.45" (11.5 mm)	5"	17" (43 cm)

Phenolic handles autoclavable to 290°F (143°C)

Specialty Elevators

DARRACH ELEVATORS



Useful in shoulder surgery. Blunt tips with serrations can be used to elevate or retract soft tissue and muscle from the operative site.

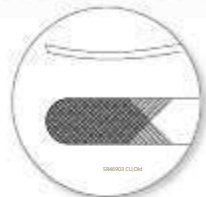

GS46903



GS46902



GS46904

Catalog#	Description
GS46902	Small, 1/2" (12 mm) wide at tip, 10-1/4" (26 cm)
GS46903	Medium, 3/4" (19 mm) wide at tip, 10-1/4" (26 cm)
GS46904	Large, 1" (25 mm) wide at tip, 13-3/4" (35 cm)

DISSECTORS AND ELEVATORS

Specialty Elevators

HARRINGTON SPINAL ELEVATOR



GS55798

All stainless steel.

Catalog #	Description
GS55798	Sharp, 3/4" (19 mm) wide tip, 12" (30.5 cm)

CHANDLER ELEVATORS



GS46252

Blunt, slightly curved.

Catalog #	tip Width	length
GS46250	8mm	7-1/8" (18 cm)
GS46252	12mm	8" (20.5 cm)
GS46254	17mm	9" (23 cm)
GS46256	19mm	10" (25.5 cm)



GS46250



GS46252



GS46254



GS46256

SACHS NERVE ELEVATOR

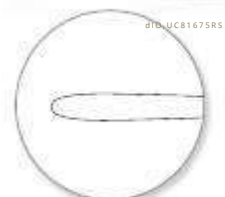

GS57618

Catalog #	Description
GS57618	3 mm blunt, 7-1/2" (19 cm)

EAR INSTRUMENTS

EAR INSTRUMENTS

Curettes

BILLEAU EAR LOOPS



411231

Catalog #	Description
411230	Small, #1, 6-1/2" (16.5 cm)
411231	Medium, #2, 6-1/2" (16.5 cm)
411232	Large, #3, 6-5/8" (17 cm)

BUCK EAR CURETTES



411202

Blunt, 6-1/2" (16.5 cm).

Catalog #	Description
411200	Size 00
411201	Size 0
411202	Size 1
411203	Size 2
411204	Size 3

DAY EAR HOOK



411241

Catalog #	Description
411241	Small, #2, 6-3/4" (17 cm)

EAR INSTRUMENTS

Curettes

HOUSE CURETTES



7" (17.7 cm), Blade A 1.8 mm, Blade B 1.5 mm.

Catalog #	Description
020300	Strongly angled
020302	Lightly angled

Elevators

HOUSE RETRACTOR

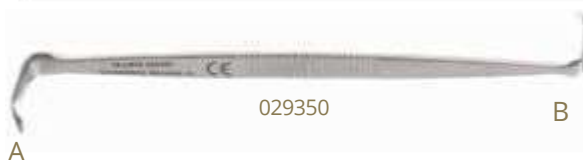

Double-ended.

Catalog #	Description
029350	Blade A 20 x 7 mm, blade B 24 x 9.5 mm, 6" (15 cm)

Forceps

ALLIGATOR FORCEPS



Serrated jaws.

Catalog #	Description
020120	6 mm, shaft 3-1/8" (8 cm)
020121	4.5 mm, shaft 3-1/8" (8 cm)

EAR INSTRUMENTS

Forceps

HARTMANN ALLIGATOR FORCEPS



Catalog #
GS55164

Description
Serrated, 12 mm jaw, 6-1/2" (16.5 cm)

GS55164

HOUSE ALLIGATOR FORCEPS



Catalog #
020100

Description
Serrated, 8 mm jaws, shaft 3-1/8" (8 cm)

020100

HARTMANN EAR DRESSING FORCEPS

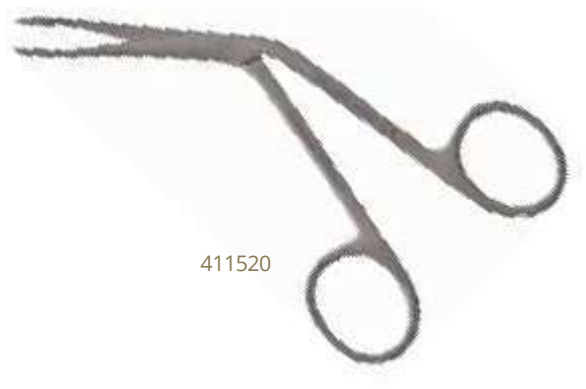

Catalog #
411520
GS55188

Description
Serrated, 2.5 x 7 mm jaws, 5-1/8" (13 cm)
Delicate, serrated, 2.2 mm x 7 mm jaws,
5" (12.5 cm)

411520

MICROMINIATURE ALLIGATOR FORCEPS



Catalog #
020571

Description
Straight, serrated, ebonized, shaft 3-1/8" (8 cm)

020571

EAR INSTRUMENTS

Forceps

HOUSE STRUT FORCEPS



Catalog #
020130

Description
Smooth jaws, 5 mm, 3-1/8" (8 cm)

TOBEY EAR FORCEPS



Catalog #
411515

Description
Serrated, 2 x 3 mm jaws, working length 2" (5 cm)

NOYES EAR FORCEPS



Catalog #
411525

Description
Serrated, 2 x 10 mm jaws, 3-1/2" (9 cm)

EAR INSTRUMENTS

Forceps

HARTMANN-HERZFELD CUP FORCEPS



Straight.

Catalog #	Description
411535	2 mm cups, shaft length 3-3/8" (9 cm)
411540	3 mm cups, shaft length 3-3/8" (9 cm)

ROUND CUP FORCEPS



Catalog #	Description
020165	0.75 mm cup jaws, shaft 3-1/8" (8 cm)

OVAL SPOON FORCEPS



Catalog #	Description
020155	Straight, 1 mm cup, 3-1/8" (8 cm)

EAR INSTRUMENTS

Forceps

WILDE EAR FORCEPS



Catalog #
GS57176

Description
Angular, delicate, serrated, 4-1/8" (10.5 cm)

Scissors

BELLUCCI ALLIGATOR SCISSORS



Catalog #
020210
020211

Description
Curved right, 5 mm blades, shaft 3-3/8" (8.5 cm)
Curved left, 5 mm blades, shaft 3-3/8" (8.5 cm)

EAR INSTRUMENTS

Scissors

HOUSE BELLUCCI MINI ALLIGATOR SCISSORS



Catalog #
020204

Description
Straight, sharp, 4.5 mm blades, 3-1/8" (8 cm)

Specula

BOUCHERON EAR SPECULUM



025101

Round.

Catalog #
025100
025101
025102
025103
025104

Description
Complete set of four
Size 1, diameter 3 mm
Size 2, diameter 3.5 mm
Size 3, diameter 4.5 mm
Size 4, diameter 5 mm

EAR INSTRUMENTS

Specula

FARRIER OVAL SPECULUM



025163

Oval.

Catalog #	Description
025160	Size 3 x 4 mm
025162	Size 4 x 5 mm
025163	Size 4.5 x 5.5 mm
025164	Size 5 x 6 mm
025165	Size 5.5 x 6.5 mm
025166	Size 6 x 7 mm
025167	Size 6.5 x 7.5 mm
025168	Size 7 x 8 mm
025169	Size 7.5 x 8.5 mm

HARTMANN EAR SPECULUM



411140

Round and oval.

Catalog #	Description
411140	Round, chrome plated, set of four
411145	Oval, chrome plated, set of four

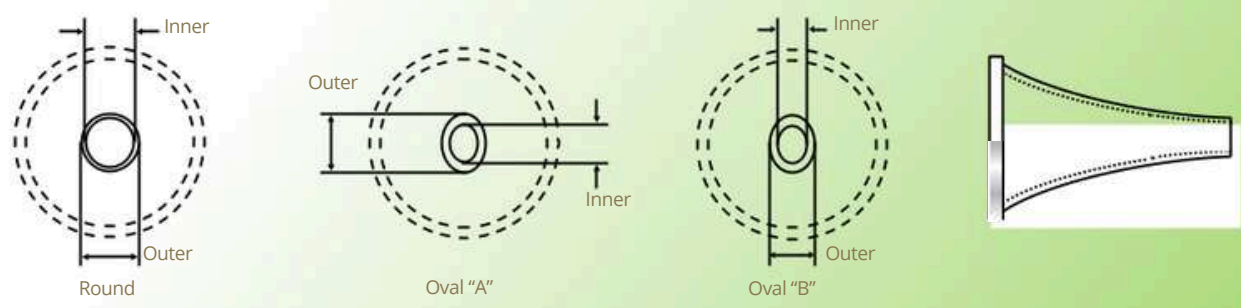

Catalog #	shape	size 1		size 2		size 3		size 4		
		i.D.	o.D.	i.D.	o.D.	i.D.	o.D.	i.D.	o.D.	
411140	Round	3mm	4mm	4mm	5mm	5.5mm	6.5mm	7mm	8mm	
411145	Oval	A	3.5 mm	4.5 mm	4.5 mm	5.5 mm	5.5 mm	6.5 mm	6.5 mm	7.5 mm
		B	2.5 mm	3.5 mm	3.5 mm	4.5 mm	4.5 mm	5.5 mm	5.5 mm	6.5 mm

EAR INSTRUMENTS

Specula

GRUBER EAR SPECULUM



GS56172

Oval. Adult, chrome.

Catalog #	Description
GS56168	#1,4x5mm
GS56170	#2,5x6mm
GS56172	#3,6x7mm
GS56174	#4,7x8mm

ENDAURAL EAR SPECULUM



029480

Catalog #	Description
029480	26 mm blade, strongly curved shaft, 5-5/8" (14.5 cm)

Miscellaneous

FARRELL (LATHBURY) APPLICATOR



411165

Catalog #	Description
411165	Twisted end, 6-1/4" (16 cm)
411166	Triangular end, 6-3/8" (16 cm)

EAR INSTRUMENTS

Miscellaneous

MYRINGOTOMY KNIFE



026510

Catalog #
026510

Description
Straight, 7 x 2 x 0.5 mm blade, 6-1/2" (16.5 cm)

GROSS SPOON AND HOOK



GS56104

Catalog #
GS56104

Description
3.5 mm diameter spoon, 4 mm right angle hook,
4-3/4" (12 cm)

ELECTRO SURGERY

ELECTROSURGERY

Biceps Non-stick Bipolar Forceps and Cords

WECK® BICEPS JEWELERS FORCEPS



394250

Straight, non-stick bipolar forceps, non-sterile.

Catalog #	Description
394250	#5, 0.5 mm tips, without stops, 4-3/4" (12.5 cm)

WECK® BICEPS BAYONET FORCEPS



394267

Straight, non-stick bipolar forceps, non-sterile.

Catalog #	Description
394807	0.5 mm tips, without stops, 7-1/2" (19 cm)
394267	0.5 mm tips, with stops, 8" (20.5 cm)
394258	1.0 mm tips, with stops, 8" (20.5 cm)

WECK® BICEPS CERULLO BAYONET FORCEPS

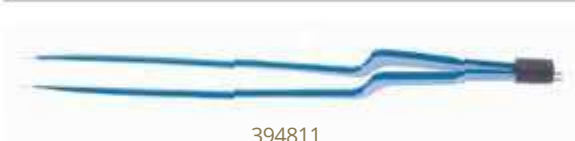

394811

Straight, non-stick bipolar forceps, non-sterile.

Catalog #	Description
394811	0.5 mm tips, without stops, 10" (25.5 cm)

WECK® BICEPS FORCEPS CORDS



394246

Fits all Biceps®Forceps.

Catalog #	Description
394246	Disposable, sterile, 12' (3.6 m), 10 per box
394247	Non-sterile, 12' (3.6 m)



394247

ELECTROSURGERY

Biceps Forceps and Cords

WECK® BIPOLAR ADSON FORCEPS



392028

Straight, bipolar forceps, non-sterile.

Catalog #	Description
392026	1.0 mm tips, non-insulated, 5" (12.5 cm)
392028	1.0 mm tips, insulated, 5" (12.5 cm)

WECK® BIPOLAR CUSHING FORCEPS



191023

Straight, bipolar forceps, non-sterile.

Catalog #	Description
191023	1.5 mm tips, insulated, 7" (18 cm)

WECK® BIPOLAR CUSHING BAYONET FORCEPS



392036

Straight, bipolar forceps, insulated, non-sterile.

Catalog #	Description
392034	0.7 mm tips, 7-1/2" (19 cm)
392036	1.0 mm tips, 7-1/2" (19 cm)
392204	1.5 mm tips, 7-3/4" (19.5 cm)
191025	2.0 mm tips, 7-1/2" (19 cm)

WECK® BIPOLAR SCOVILLE-GREENWOOD BAYONET FORCEPS



392014

Straight, bipolar forceps, non-sterile.

Catalog #	Description
392012	1.5 mm tips, non-insulated, 7-3/4" (19.5 cm)
392014	1.5 mm tips, insulated, 7-3/4" (19.5 cm)

ELECTROSURGERY

Biceps Forceps and Cords

WECK® BIPOLAR IRIS FORCEPS



392043

Straight, bipolar forceps, non-sterile.

Catalog #	Description
392043	0.4 mm tips, serrated handle, 3-1/2" (9 cm)

WECK® BIPOLAR JEWELER'S FORCEPS



392018

Catalog #	Description
392018	0.4 mm tips, smooth handle, 4" (10 cm)

WECK® BIPOLAR SEMKIN FORCEPS



392040

Straight, bipolar forceps, non-sterile.

Catalog #	Description
392040	0.7 mm tips, with stops, 5-1/2" (14 cm)

WECK® BIPOLAR FORCEPS CORDS



394237

Fits all standard bipolar forceps.

Catalog #	Description
394236	Disposable, sterile, 12' (3.6 m), 10 per box
394237	Rubber, non-sterile, 12' (3.6 m)
394238	Silicone, non-sterile, 12' (3.6 m)



394238

ELECTROSURGERY

Disposable Electrodes

WECK® DISPOSABLE ELECTRODES



Sterile, 24 per box.

Catalog #	Description
809315	Blade electrode, 3/4" (19 mm) blade, 2-3/4" (7 cm)
809319	Blade electrode, 3/4" (19 mm) blade, 6" (15 cm) extended length
809316	Needle electrode, 3/4" (19 mm) blunt needle, 1/32" (0.7 mm) dia., 2-3/4" (7 cm)
809317	Needle electrode, 3/4" (19 mm) needle, 1/32" (0.7 mm) dia., 2-3/4" (7 cm)
809318	Needle electrode, 3/4" (19 mm) needle, 1/32" (0.7 mm) dia., 6" (15 cm) extended length

WECK® DISPOSABLE IMA/ENT ELECTRODES



Sterile, 24 per box.

Catalog #	Description
809335	Blade electrode, 3/4" (2 cm) blade, extended insulation, 2-3/4" (7 cm)
809339	Blade electrode, 3/4" (2 cm) blade, extended insulation, 6" (15 cm) extended length
809337	Needle electrode, 3/4" (2 cm) needle, 1/32" dia., extended insulation, 2-3/4" (7 cm)
809338	Needle electrode, 3/4" (2 cm) needle, 1/32" dia., extended insulation, 6" (15 cm) extended length

ELECTROSURGERY

Monopolar Handswitching Forceps

WECK® MONOPOLAR HANDSWITCHING FORCEPS



809267

Non-sterile.

Catalog #	Description
809267	Curved inward, 2.0 mm tips, insulated, 8" (20.5 cm), 10' (3 m) cord

ELECTROSURGERY

Coagulation Suction Tubes

COAGULATION SUCTION TUBES



809600

Disposable foot control coagulation suction tubes, sterile, 10 per box.

Catalog #	Description
809600	11 French, with stylet, 6" (15 cm)
809610	11 French, with stylet, 8" (20.5 cm)

MISCELLANEOUS GENERAL

MISCELLANEOUS GENERAL

Probes, Cannulae and Dilators

WILLIAMS LACRIMAL PROBES



166490

5-1/8" (13 cm).

Catalog #	Description
166480	Size 1-2
166485	Size 3-4
166490	Size 5-6
166495	Size 7-8

BOWMAN LACRIMAL PROBES



426096

Sterling silver, 4-7/8" (12.5 cm).

Catalog #	Description
426090	Size 0000-000
426092	Size 00-0
426094	Size 1-2
426096	Size 3-4
426098	Size 5-6
427002	Size 7-8

DOUBLE-ENDED PROBES



166573

Stainless steel.

Catalog #	Description
166571	5-1/8" (13 cm)
166573	6-1/8" (15.5 cm)

GROOVED DIRECTOR AND TONGUE TIES



166611

Plain end, stainless steel.

Catalog #	Description
166610	4-1/2" (11.5 cm)
166611	5-1/8" (13 cm)
166612	5-3/4" (14.5 cm)
166613	6-1/4" (16 cm)

GROOVED DIRECTORS

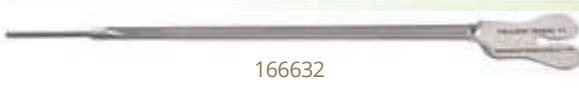

166632

Probe point, stainless steel.

Catalog #	Description
166632	5-1/2" (14 cm)
166633	6-1/4" (16 cm)

MISCELLANEOUS GENERAL

Probes, Cannulae and Dilators

PROBES WITH PROXIMAL EYE



166503



GS42618

Malleable, stainless steel.

Catalog #	Description
166500	4-1/2" (11.5 cm)
166501	5-1/8" (13 cm)
166502	5-3/4" (14.5 cm)
166503	5-7/8" (15 cm)
166504	7-1/8" (18 cm)
166505	7-7/8" (20 cm)
166507	9-7/8" (25 cm)
GS42618	10" (25.5 cm)

PROBES WITH PROXIMAL EYE



166523

Sterling silver.

Catalog #	Description
166520	4-1/2" (11.5 cm)
166521	5-1/8" (13 cm)
166522	5-3/4" (14.5 cm)
166523	5-7/8" (15 cm)
166527	9-7/8" (25 cm)

PATTERSON TROCAR AND CANNULA



534203

Stainless steel trocar tip with chrome plated handle allows for easy catheter insertion.

Catalog #	Description
534201	Size 1, for 14 Fr. catheter, 7-3/4" (19.5 cm)
534202	Size 2, for 20 Fr. catheter, 8" (20.5 cm)
534203	Size 3, for 26 Fr. catheter, 8" (20.5 cm)

MISCELLANEOUS GENERAL

Probes, Cannulae and Dilators

BAKES COMMON DUCT DILATORS SET

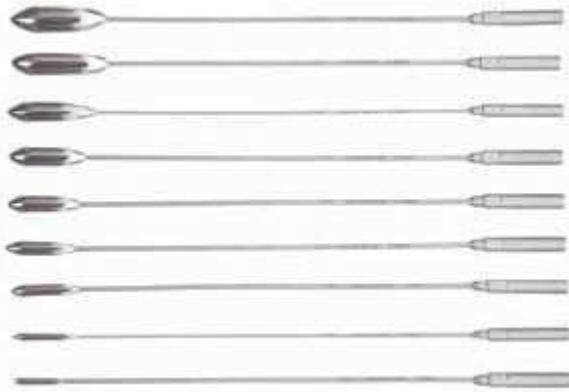

172700

Catalog #	Description
172700	Malleable stainless steel shafts. 9 tip sizes, 3 to 11 mm. Overall length 8-1/2" (21.5 cm). Set of 9 in plastic case.

Measuring Devices

RULERS



GS39694

Flexible, graduated in inches and millimeters.

Catalog #	Description
GS39692	6" (15 cm)
GS39694	8" (20.5 cm)
GS39698	12" (30.5 cm)
GS39700	20" (51 cm)

CENTIMETER SUBTRACTION RULER



504075

For accurate calculation, by subtraction, of the depth to which a scope has been inserted.

Catalog #	Description
504075	30cm

KUNTSCHER X-RAY SCALE



GS48299

Catalog #	Description
GS48299	Graduated in millimeters, 50 cm length (19-5/8")

MISCELLANEOUS GENERAL

Measuring Devices

POLK FINGER GONIOMETER



GS48310

Graduated in centimeters and inches.

Catalog #	Description
GS48310	6" (15 cm)

CASTROVIEJO CALIPERS



GS53042



428630

Catalog #	Description
GS53042	Graduated to 40 mm, 6-1/2" (16.5 cm)
428630	Straight, 0-20 mm scale, 3-3/8" (8.5 cm)

BONE COMPASS



GS48302

Catalog #	Description
GS48302	8" (20.5 cm)

MISCELLANEOUS GENERAL

Measuring Devices

TOWNLEY FEMUR CALIPER



GS48314

Catalog #
GS48314

Description
Takes inside and outside measurements
up to 4" (10 cm)

FOX CURETTES



GS29498

Round, 5-1/2" (14 cm).

Catalog #	Description
GS29495	1mm
GS29496	2mm
GS29497	3mm
GS29498	4mm
GS29499	5mm
GS29500	6mm

MISCELLANEOUS GENERAL

Dermal Instruments

GREG COMDONE EXTRACTOR



GS29606

Catalog #
GS29606

Description
One fenestrated cup and lancet blade with cap,
5" (12.5 cm)

KEYES DERMAL SKIN PUNCHES



GS29513

Straight, sharp ring. 4" (10 cm).

Catalog #	Description
GS29511	2mm
GS29512	3mm
GS29513	4mm
GS29514	5mm
GS29515	6mm
GS29517	7mm

COMDONE EXTRACTOR (WALTON)



GS29604

Catalog #
GS29604

Description
One fenestrated cup and curved lancet with cap

MISCELLANEOUS GENERAL

Dermal Instruments

PIFFARD CURETTES



GS29505

Oval, 5-1/2" (14 cm).

Catalog #	Description
GS29503	#1 small
GS29505	#2 medium
GS29507	#3 large

SAALFELD COMDONE EXTRACTOR



GS29566

Catalog #
GS29566Description
Extra-fine, with lancet and one fenestrated cup,
4-1/2" (11.5 cm)

SCHAMBERG COMDONE EXTRACTORS



GS29582

3-3/4" (9.5 cm).

Catalog #	Description
GS29580	Standard, crimped loops
GS29582	Extra-fine, crimped loops
GS29584	Square loops

UNNA COMDONE EXTRACTOR



GS29592

Catalog #
GS29592Description
Fenestrated spoon ends, 5-3/4" (14.5 cm)

MISCELLANEOUS GENERAL

Ligature Carriers and Wire Passers

DESCHAMPS LIGATURE CARRIERS



Catalog #
152255
152256

Description
Blunt point, left curved, 8-1/8" (20.5 cm)
Blunt point, right curved, 8-1/8" (20.5 cm)

BERCI SUTURE PASSER



Catalog #
P47482

Description
2.8 mm, 6-3/4" (17 cm)

MISCELLANEOUS CVT

Endarterectomy Dissectors

EFFLER-GROVES DOUBLE-END DISSECTOR AND HOOK



355810

Catalog #
355810

Description
Lightweight, 12-1/4" (31 cm)

LEMMON INTIMA DISSECTORS



355191

Catalog #
355191
355192

Description
Slight curve, 6-3/8" (16.5 cm)
Acute curve, 6-3/8" (16.5 cm)

OLIVEKRONA DOUBLE-END DISSECTORS



355182



355186

Very useful as freeing instruments in endarterectomy.

Catalog #
355180
355182
355184
355186

Description
Lightweight, 7-1/4" (18.5 cm)
Lightweight, 9-1/2" (24 cm)
Heavy weight, 7-3/4" (19.5 cm)
Heavy weight, 9-1/2" (24 cm)

FREER DOUBLE-END ELEVATOR



355194

. Pattern, satin finish.

Catalog #
355194

Description
Sharp and blunt, 7" (18 cm)

MISCELLANEOUS CVT

Marking Rings

MARKING RING-VEIN GRAFT



355834

The aorta to coronary saphenous vein graft is widely used for the treatment of coronary atherosclerosis. Assessment of the post-operative result requires direct catheterization of the graft, and locating the proximal orifice can be difficult. The Vein Graft Ring is designed to be placed around the aortic end of the graft prior to completion of the proximal anastomosis. After completion of the proximal anastomosis the ring is sutured to the aorta by interrupted 5-0 or 6-0 sutures. The ring has been found helpful to the cardiologist in locating the aortic end of the graft. The rings are made of 20 Ga., type 316L medical grade stainless steel, available in diameters of 8, 10, 12 and 14 mm.

Catalog #	Description
355830	CC Marking Ring, 8 mm, 10/pack
355832	CC Marking Ring, 10 mm, 10/pack
355834	CC Marking Ring, 12 mm, 10/pack
355838	CC Marking Ring, 14 mm, 10/pack

Obturator

FITCH OBTURATORS



351316

Fitch Obturators, olive tipped, for use with plastic vena cava catheters in open heart surgery. These obturators permit introduction of the venous drainage catheters into the right atrium and vena cava. Olive-shaped tip allows easy introduction through a purse-stringed site in the right atrium. The elongated head of the obturator is designed to block any blood entering the multiple perforations of the catheter during introduction. The malleable shaft permits control of the catheter tip in the right atrium, and appropriately precurving the shaft allows the catheter to be steered into either vena cava.

Catalog #	Description
351316	26 Fr., 17-7/8" (45.5 cm)
351318	30 Fr., 16-1/8" (41 cm)

MISCELLANEOUS CVT

TourniquetStylets

REPLACEMENT STYLET FOR RUMEL TOURNIQUET

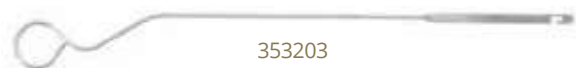

353203

Catalog #
353203

Description

66 x 4 mm tip, working length 7-5/8" (19.5 cm),
overall length 10-1/4" (26 cm)

STYLET FOR RUMEL TOURNIQUET, CHILD SIZE



353207

Catalog #
353207

Description

Often used with rubber tubing and Identi-Loops,
7" (18 cm)

STYLET FOR WECK® STYLE RUMEL TOURNIQUET



353206

Catalog #
353206

Description

2 mm-wide tip, working length 8-1/4" (21 cm),
overall length 9-3/8" (24 cm)

MISCELLANEOUS CVT

Tunnelers

BERRY ANGIO ACCESS TUNNELER



Designed by William B. Berry, M.D. of Pasadena, Texas, Angio Access Tunneler (355500) is used to create forearm loop tunnels for placement of arteriovenous grafts for hemodialysis. Removable interchangeable handle and bullet tip allow:

- Simplified surgical procedure with better surgical control.
- Reduced likelihood of "kinking".
- Less patient trauma.

Diamond knurled handle for ease of control. Suture hole in bullet tip allows secure graft attachment.

Catalog #	Description
355500	Available in 10-3/4" (27.5 cm) length (105 degree arc)

CRAWFORD-COOLEY GRAFT TUNNELER



Graft is attached to obturator tip and drawn through the tube. Tube is then withdrawn, leaving graft placed in untwisted position.

Catalog #	Description
355497	Tube slightly curved, 12 mm I.D., 17-1/2" (44.5 cm)

MISCELLANEOUS CVT

Tunnelers

DEBAKEY® FEMORAL BYPASS TUNNELER

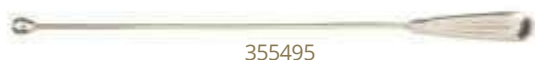

355495

For use in by-pass operation for segmental occlusive disease of the iliac and femoral arteries. This instrument is designed with a slightly malleable stainless steel bar with a handle on one end and an olive tip dilator on the other. This blunt end, introduced through one of the incisions, is inserted through the subcutaneous tissue into the other incision. A by-pass graft end is then attached by a simple ligature to the olive tip end which is withdrawn, pulling the graft through the subcutaneous tunnel connecting the two incisions.

Catalog #	Description
355495	20-3/4" (52.5 cm)

HALLMAN TUNNELING FORCEPS



355493

Catalog #	Description
355493	14-5/8" (37 cm)

MISCELLANEOUS ORTHOPEDIC

MISCELLANEOUS ORTHOPEDIC

Ring Cutters

ORTHOPEDIC INSTRUMENTS

FINGER RING CUTTER



GS29430



GS29434

Catalog #	Description
GS29430	Chrome, with saw blade, 6-1/4" (16 cm)
GS29434	Saw blade only

Diagnostic Instruments

BUCK NEURO HAMMER STAINLESS



GS28492

Stainless steel with brush and needle.

Catalog #	Description
GS28492	7-3/4" (19.5 cm)

MISCELLANEOUS ORTHOPEDIC

Diagnostic Instruments

TAYLOR PERCUSSION HAMMER



GS28468

Catalog #
GS28468Description
8" (20.5 cm)

WARTENBERG NEUROLOGICAL PIN WHEEL



GS28514

Catalog #
GS28514Description
7" (18 cm)

Specialty Hand Instruments

JOHNSON-TUCKER HOOK AND FORK



GS69790

Catalog #
GS69790Description
Double-ended, delicate, 6-1/2" (16.5 cm)

MISCELLANEOUS ORTHOPEDIC

Specialty Hand Instruments

ORTHOPEDIC INSTRUMENTS

EXCAVATOR AND PACKER



GS69502

Catalog #
GS69502Description
Double-ended

PROBE AND PACKER

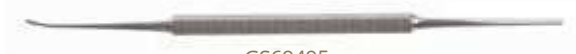

GS69495

Catalog #
GS69495Description
Double-ended, 1 mm and 2 mm ends, 6" (15 cm)

SPATULA AND PACKER



GS69498

Catalog #
GS69498Description
Double-ended, 5-3/4" (14.5 cm)

VERUCCA CURETTE EXCAVATOR



GS69457

With McGlamry Bullneck. Will resist bending

Catalog #
GS69457Description
Single-ended, straight, 4 mm without hole,
5" (12.5 cm)

MISCELLANEOUS ORTHOPEDIC

Specialty Hand Instruments

CURETTE EXCAVATORS

	<p>Catalog # GS69488 GS69492</p>	<p>Description Double-ended, 1.5 mm and 2.0 mm ends, 5-1/2" (14 cm) Double-ended, 1.5 mm and 2.5 mm ends, 5-1/2" (14 cm)</p>
	<p>GS69488</p>	

CURETTE EXCAVATORS

	<p>Single-ended, with hole, 5" (12.5 cm).</p>	
	<p>Catalog # GS69468 GS69478 GS69480 GS69484</p>	<p>Description #58, 1.0 mm #58, 1.5 mm #58, 2.0 mm #58, 2.5 mm</p>
<p>GS69480</p>		

CURETTE EXCAVATORS

	<p>Single-ended, without hole, 5" (12.5 cm).</p>	
	<p>Catalog # GS69459 GS69461 GS69463 GS69465</p>	<p>Description #57, 1.0 mm #57, 1.5 mm #57, 2.0 mm #57, 2.5 mm</p>
<p>GS69463</p>		

MISCELLANEOUS ORTHOPEDIC

Specialty Hand Instruments

ORTHOPEDIC INSTRUMENTS

WOCKE ELEVATORS



GS69579

With McGlamry Bullneck. Will resist bending

Catalog #	Description
GS69579	Narrow blade, single-ended, 4-1/2" (11.5 cm)
GS69590	Wide blade, single-ended, 5" (12.5 cm)

CORN KNIVES



GS69623

Single-ended.



GS69625

Catalog #	Description
GS69622	Soft Corn Knife, #45, straight, round blade
GS69623	Soft Corn Spoon Knife, slightly curved, oval blade
GS69625	Corn Knife, curved

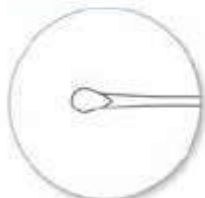

GS69622

GOLF STICK KNIVES



GS69620

Catalog #	Description
GS69618	#41 #43
GS69620	

MISCELLANEOUS ORTHOPEDIC

Specialty Hand Instruments

CHISELS

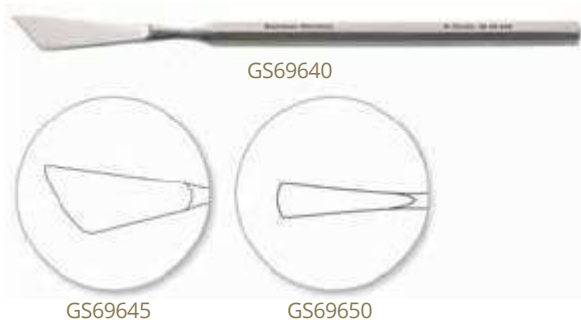

Catalog #	Description
GS69640	Curved, medium
GS69645	Curved, extra-large
GS69650	Curved, spade pattern

WRIST TENDON APPROXIMATOR

Catalog #
GS52450

MISCELLANEOUS ORTHOPEDIC

ORTHOPEDIC INSTRUMENTS

CELVIC BALL SPIKE



GS47906

Catalog #
GS47906
GS47921

Description
Straight, 11-3/4" (30 cm)
Spiked disk only



GS47921

BONE MILL



GS98200

Catalog #
GS98200

Description
With crank and table clamp

CVT RETRACTORS

CVT RETRACTORS

Epicardial

PARSONNET EPICARDIAL RETRACTOR



342025

Designed to retract the epicardial fat during coronary by-pass procedures. Miniature spring style retractor. For low-profile epicardial tissue retraction at coronary anastomosis site.

Catalog #	Description
342025	3 x 3-pronged, 1-1/16" (27 mm) spread, 1-7/8" (4.5 cm) long

IMA

CHAUX MULTIPURPOSE STERNAL IMA RETRACTOR



341150

The Chaux Sternal Retractor is a unique instrument that can be used not only for routine midline sternotomy, but also for exposure and dissection of the left or right internal thoracic artery. In addition, accessory interchangeable parts consisting of a full set of mitral retracting blades are available to allow self-retaining retraction during valve surgery.

- Four sternal blades with individual and independent dual movement.
- Sliding sternal blade assemblies allow finite positioning of sternal blades on the horizontal planes of side arms.
- For upward elevation required during IMA dissection, both side arms can be rotated and locked at 30 degrees or 60 degrees along its axis.
- All components of retractor remain in sterile field.

Catalog #	Description
341150	Spread 8" (20.5 cm) Blades 1-1/8" wide x 1-7/16" deep (2.5 x 3.5 cm), Arm length 12" (30.5 cm)

CVT RETRACTORS

IMA

CHAUX STERNAL IMA-MITRAL VALVE RETRACTOR



341155

Three retractors in one, can be used as a sternal/IMA and valve retractor. Includes four sternal blades with individual and independent dual movement. Sliding sternal blade assemblies allow movement on horizontal planes of side arms to provide proper position adjustment according to length of sternum. Both side arms can be rotated and locked at 30 degrees or 60 degrees along its axis for flexibility in positioning the retractor for IMA exposure. All components of the retractor remain in the sterile field. The valve retractor fits directly onto arms of the sternal blade assembly and provides self-retaining valve retraction. The Chaux Sternal IMA Valve Retractor when used for valve surgery consists of the basic Chaux Retractor with the addition of a Lemole- Valve Retractor Set (341501) and Valve Sternal Blade Assembly (341149).

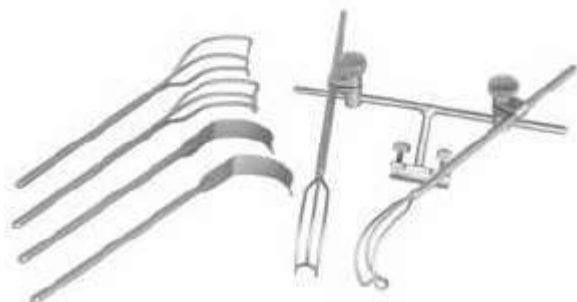

341501



341520

Catalog #	Description
341155	Chaux Sternal/IMA Valve Retractor Set Spread: 9-1/8" (23 cm) Blade measure: 1-1/8" (2.5 cm) wide x 1-1/4" (3 cm) deep
341501	Lemole- Valve Retractor Set #1 Set #1 fits Cooley and Chaux Sternal Retractors
341520	Universal Clamp for Lemole
341522	Cooley Atrial Retractor, small, 9-1/2" (24 cm)
341523	Cooley Atrial Retractor, medium, 9-1/2" (24 cm)
341524	Cooley Atrial Retractor, large, 9-1/2" (24 cm)
341525	Malleable Atrial Retractor, 8-3/4" (22 cm)
341147	Lemole- Valve Retractor (341501) and Valve Sternal Blade Assembly (341149) (Part of 341155)



341522

341523

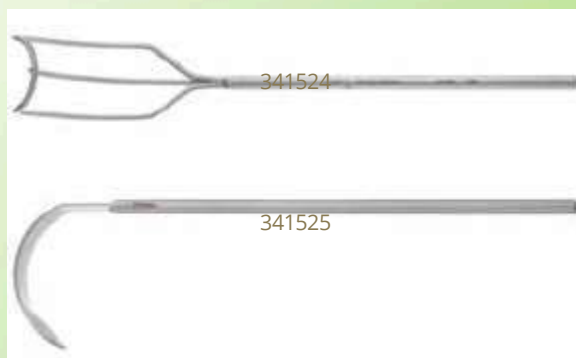

341524

341525

CVT RETRACTORS

IMA

CHAUX DEEP BLADE ASSEMBLY



341148

Catalog #	Description
341148	1-3/4" (4.5 cm)

VALVE STERNAL BLADE ASSEMBLY



341149



341154



341156

Catalog #	Description
341149	(Part of 341155)
341154	Chaux Sternal Assembly Thumb Screw
341156	Chaux Sternal Arm Take-up Screw

CVT RETRACTORS

IMA

COUËTIL IMA STERNAL RETRACTOR



All components remain in the sterile field, giving you exposure and set-up control.

Catalog #	Description
341139	Ratcheted blades slide freely on retractor arm

. IMA RETRACTOR



All components remain in the sterile field, giving you exposure and set-up control.

Catalog #	Description
341136	Replaces 341134 . Bugge IMA Retractor

OCHSNER-FAVALORO IMPROVED RETRACTOR SET WITH RAIL CLAMPS



Designed for sternal retraction during internal mammary artery dissection. Rake retractors have screw-type handles for easier adjustment and blunt tips to prevent injury to the sternum. Supplied with two Gomez/Poly-tract Rail Clamps (Catalog # 341114) for ease of assembly over sterile drapes.

Catalog #	Description
341120	Consists of: 2 each retractor uprights, 1 each crossbar, 2 each screw-type rake assemblies and 2 each 341114 Gomez/Poly-tract Rail Clamps

CVT RETRACTORS

IMA

OCHSNER-FAVALORO RETRACTOR PARTS

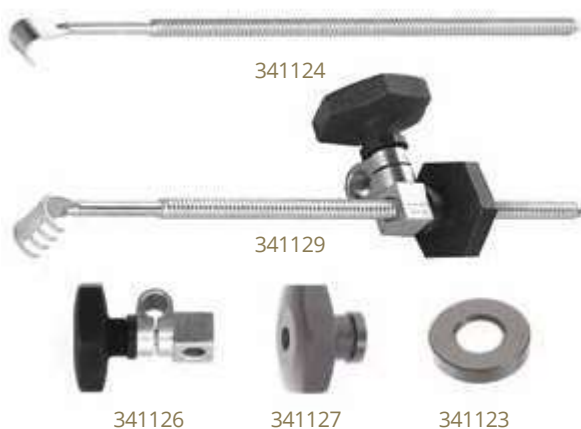

Catalog #	Description
341123	Captive Washer for Knob
341124	Micro Adjustable Rake and Arm
341126	Knob and Clamp Assembly
341127	Micro Adjust Knob
341129	Rake Assembly for Ochsner-Favaloro Self-Retaining Retractors 341120 and 341128

OCHSNER-FAVALORO RETRACTOR SET



The Favaloro Retractor modified with screw-type handles for ease of adjustment of retraction, longer arms for ease of assembly and blunt tips to help prevent injury to the sternum.

Catalog #	Description
341128	Supplied with one pair of rail clamps for most standard OR tables.

CVT RETRACTORS

IMA

RAIL CLAMPS



343393

To facilitate transfer of the retractor to opposite side of the table, we suggest an additional pair of rail clamps.

Catalog #	Description
343393	One pair

CHEANVECHAI RAKE ASSEMBLY



341131

Catalog #	Description
341131	May be used with any existing .-made Favaloro-type cross bars and uprights (included with the Strong Retractor)

CHEANVECHAI-FAVALORO SWIVEL RAKE ASSEMBLY

Catalog #
341133



341133

Description
Same as 341131 except rakes swivel

CVT RETRACTORS

IMA

STRONG T-BAR RETRACTOR SYSTEM



Single post, table-mounted IMA Retractor with Cheanvechai Adjustable Rakes. (Shown with optional Retractor Light Beam, 163701.)

Catalog #	Description
341100	Retractor System

STRONG T-BAR UNILATERAL SYSTEM COMPONENTS



Catalog #	Description
341112	Strong support bar, table upright diameter 5/8" (1.5 cm)
341113	Strong T-Bar
341131	Cheanvechai-Favaloro Rake Assembly
341114	Rail Clamp for Strong T-Bar, 5/8" (1.5 cm)
166002	Set of four 341114 Rail Clamps



CVT RETRACTORS

Sternal Retractors/Rib Spreaders

PREEMIE RETRACTOR



341312

The smallest . Chest Retractor. For premature infants less than 2 kg body weight.

Catalog #	Description
341312	Spread 1-9/16" (4.0 cm) Fixed blades 5/16" deep x 1/4" wide (8 x 6.5 mm) Arm length 1" (2.5 cm)

DAVIS-FINOCHIETTO INFANT RETRACTOR



341290

Miniature size for use in infants. Especially valuable in surgery for tracheoesophageal fistula. Stainless steel.

Catalog #	Description
341290	Spread 2-3/4" (7 cm) Blades 1/2" deep x 5/8" wide (1.3 x 1.5 cm) Arm length 2-1/16" (5 cm)

FINOCHIETTO RIB RETRACTOR



341302

Infant size, for newborn and tiny infants. Aluminum construction.

Catalog #	Description
341302	Spread 2-3/4" (7 cm) Blades 1/2" deep x 5/8" wide (1.3 x 1.5 cm) Arm length 2-1/4" (6 cm)

CVT RETRACTORS

Sternal Retractors/Rib Spreaders

WILCOX PEDIATRIC CARDIAC RETRACTOR



341315

A miniature model of the Finochietto. Light construction, stainless steel.

Catalog #	Description
341315	Spread 2-3/4" (7 cm) Blades 7/8" deep x 7/8" wide (2.2 x 2.1 cm)

AMATO NEONATAL STERNAL RETRACTORS



341303

Specially designed infant sternal retractors to reduce post-operative sternal deformity by dispensing pressure over greater surface area. Selection of 3 sizes available for proper fit.

Catalog #	Description
341303	Amato Retractor, 4 blade, small Swivel blades 3/8" wide x 3/8" deep (1 x 1 cm)
341304	Amato Retractor, 4 blade, medium Maximum spread 2-3/4" (7 cm) Swivel blades 1/2" wide x 1/2" deep (1.5 x 1.5 cm)
341305	Amato Retractor, 6 blade, large Spread 2-1/2" (6.5 cm) Swivel blades 1/2" wide x 1/2" deep (1.5 x 1.5 cm)



341304



341305

CVT RETRACTORS

Sternal Retractors/Rib Spreaders

DEBAKEY CHILDRETRACTOR

®



341317

Lightweight aluminum arms and blades are dull finished to eliminate glare and curved to follow body contour. Rack is stainless steel.

Catalog #	Description
341317	Spread 3-3/4" (9.5 cm) Blades 1-1/8" deep x 1-1/8" wide (3 x 3 cm) Arm length 3-1/8" (8 cm)

BURFORD-FINOCHIETTO INFANT-CHILD RETRACTOR



341250

Stainless steel. This retractor is equipped with interchangeable blades, an important feature that eliminates the need for more than one spreader. Smaller-scaled and lighter weight than the adult size, it provides a 5-7/8" (15 cm) spread.

Catalog #	Description
341250	Infant-Child Spread 5-7/8" (15 cm) Supplied with four pairs of stainless side blades: 1" deep x 15/16" wide (2.5 x 2.4 cm) 1-1/4" deep x 1-5/16" wide (3.2 x 3.3 cm) 1-1/4" deep x 1-3/4" wide (3.2 x 4.4 cm) 1-7/8" deep x 1-3/4" wide (4.9 x 4.4 cm) Arm length 4-1/4" (10.8 cm)

GERBODE-BURFORD CHILD RETRACTOR



341200

Stainless steel. Has same projection-free construction as adult models but is proportionally reduced to child size.

Catalog #	Description
341200	Child Spread 5-15/16" (15 cm) Supplied with four pairs of side blades: 3/4" deep x 1" wide (1.9 x 2.5 cm) 1-1/16" deep x 1-1/4" wide (2.7 x 3.2 cm) 1-1/16" deep x 1-3/4" wide (2.7 x 4.4 cm) 1-7/8" deep x 1-3/4" wide (4.8 x 4.4 cm) Arm length 4-1/2" (11.5 cm)

CVT RETRACTORS

Sternal Retractors/Rib Spreaders

HAIGHT BABY RETRACTOR



341296

Light construction. Spreader arms held apart by "ratchet" mechanism.

Catalog #	Description
341296	Large Spread 4-3/4" (12 cm) Blades 1-3/8" deep x 1-1/8" wide (3.4 x 3 cm)

REPLOGLÉ INFANT STERNAL RETRACTOR



341205

Gently curved arms fit the natural contour of the infant sternum. Each blade swivels 45 degrees. 5-7/8" (15 cm) length arms place ratchet bar out of surgical field.

Catalog #	Description
341205	Spread 2-15/16" (7.5 cm) Blades 5/8" deep x 1/2" wide (1.6 x 1.3 cm) Arm length 5-7/8" (15 cm)

CVT RETRACTORS

Sternal Retractors/Rib Spreaders

FINOCHIETTO RETRACTORS

The original model. Shafts curved to follow body contour. Dull, non-glare finished stainless steel.



341326

Catalog #	Description
341326	Newborn size Spread 1-7/8" (4.9 cm) Blades 5/8" deep (1.5 cm) Straight arms
341328	Child size Spread 5-1/8" (13 cm) Blades 1-1/2" deep x 1-3/4" wide (3.8 x 4.4 cm) Arm length 5-1/4" (13.3 cm), curved arms
341330	Adult size Spread 7-1/2" (19 cm) Blades 2-1/8" deep x 2-5/8" wide (5.4 x 6.7 cm) Curved arms
341332	Adult size, large Spread 7-1/2" (19 cm) Blades 2-7/8" deep x 2-5/8" wide (7.3 x 6.7 cm) Curved arms



341328



341330



341332

CVT RETRACTORS

Sternal Retractors/Rib Spreaders

MORSE STERNAL RETRACTORS WITH DOUBLE BLADES



341158

For sternal-splitting incisions. The double blades help prevent the narrow split sternal halves from breaking in their mid-portion.

Catalog #	Description
341158	Child, age 2-5 Spread 3-7/8" (10 cm) Blades 3/8" deep x 5/8" wide (1.1 x 1.5 cm)
341160	Child Spread 6" (15.2 cm) Blades 5/8" deep x 13/16" wide (1.6 x 2.1 cm) Arm length 5" (12.7 cm)
341162	Adult Spread 8" (20.3 cm) Blades 15/16" deep x 1-1/8" wide (2.4 x 2.9 cm) Arm length 6" (15.2 cm)



341160



341162

CVT RETRACTORS

Sternal Retractors/Rib Spreaders

FAVALORO-MORSE STERNAL RETRACTORS



341163

Catalog #	Description
341163	Adult, Short Spread 8" (20.3 cm) Blades 1-1/2" deep x 1-1/8" wide (3.8 x 2.8 cm) Arm length 6" (15.2 cm)
341164	Large Adult, Long Spread 8" (20.3 cm) Blades 1-1/2" deep x 1-1/8" wide (3.8 x 2.8 cm) Arm length 8-1/16" (20.5 cm)

COOLEY STERNUM RETRACTORS



341194

Catalog #	Description
341194	Adult Spread 6-1/2" (16.5 cm) Short blades 1-1/4" deep x 2-1/4" wide (3.2 x 5.7 cm) Arm length 5-3/4" (14.6 cm)
341195	Large Adult Spread 6-5/16" (16 cm) Long, concave blades 1-1/4" deep x 4" wide (3 x 10 cm) Arm length 6-1/2" (16.5 cm)



341195

CVT RETRACTORS

Sternal Retractors/Rib Spreaders

DEBAKEY® CHEST RETRACTORS



A group of three sizes, each supplied with 2 sets of curved aluminum blades designed for use with ribs or sternum. Blades attach by a simple slide arrangement without suture catching obstructions.

Catalog #	Description
341175	Adult Spread 6-1/2" (16.5 cm) Blades 1-1/4" deep x 2-1/4" wide (3.2 x 5.7 cm) and 1-3/16" deep x 2-1/4" wide (3 x 5.7 cm)
341177	Adolescent Spread 5-1/2" (14 cm) Blades 1-1/4" deep x 1-1/8" wide (3.2 x 3 cm) and 1-3/4" deep x 1-1/8" wide (4.4 x 3 cm)
341178	Child Spread 3-7/8" (10 cm) Blades 1-1/4" deep x 1-1/8" wide (3.2 x 3 cm) and 1-1/2" deep x 1-1/8" wide (3.9 x 3 cm)

CVT RETRACTORS

Sternal Retractors/Rib Spreaders

KUYPER-MURPHY STERNAL RETRACTORS

Straight arms. Concave blades.

Catalog #	Description
341397	Small Spread 4-1/2" (11.5 cm) Blades 1-1/8" deep x 3-1/2" wide (3 x 9 cm)
341398	Medium Spread 6-5/16" (16 cm) Blades 1-3/16" deep x 3-1/2" wide (3 x 8.9 cm)



341397



341398

CVT RETRACTORS

Sternal Retractors/Rib Spreaders

RIENHOFF RETRACTORS



341362



341366

Stainless steel.

Catalog #	Description
341362	Spread 5-7/8" (15 cm) Blades 1-1/8" deep x 1-1/4" wide (3 x 3.3 cm) Spread 5-1/2" (14 cm)
341366	Blades 2" deep x 1-3/4" wide (5 x 4.4 cm) Arm height 4-5/8" (11.7 cm)

TUFFIER RETRACTOR



341390

Scored blades.

Catalog #	Description
341390	Spread 5-7/8" (15 cm) Blades 2-3/16" deep x 1-7/8" wide (5.6 x 4.8 cm) Arm length 4-1/2" (11.4 cm)

CVT RETRACTORS

Sternal Retractors/Rib Spreaders

BONCHEK-CARPENTIER STERNAL/ATRIAL VALVE RETRACTOR



341198

- Cooley-type Sternal Blades with shorter outward curve designed for easier insertion.
- Allows critical adjustment of the retractor blades to apply traction to the atrial wall.
- Both models are supplied with four atrial valve retracting blades, two narrow and two wide.

Catalog #	Description
341198	Modified Carpentier-Type Sternal/Atrial Retractor Spread 6-7/8" (17.5 cm) Sternal blades 3-15/16" wide x 1-1/4" deep (10 x 3.2 cm)

BURFORD ADULT RETRACTOR



341225

Stainless steel. Shanks are curved to fit body contour and blades are detachable. Blades have protruding points to help prevent spreader from moving during operation. Two pairs of blades are supplied.

Catalog #	Description
341225	Minimum Spread 7-1/2" (19 cm) Small blades 2-1/2" deep x 2-1/2" wide (6.5 x 6.5 cm) Large blades 3-1/4" deep x 2-5/8" wide (8.1 x 6.5 cm) Arm length 8-1/8" (20.5 cm)

BURFORD ALUMINUM ADULT RETRACTOR



341227

Two pairs of blades are supplied.

Catalog #	Description
341227	Spread 6-7/8" (17.5 cm) Small blades 1-7/8" deep x 2-3/8" wide (4.7 x 6.1 cm) Large blades 2-1/2" deep x 2-3/8" wide (6.5 x 6.1 cm) Arm length 7-11/16" (19.4 cm)

CVT RETRACTORS

Sternal Retractors/Rib Spreaders

FARRELL RUBIO RETRACTOR



Two sets of interchangeable blades.

Catalog #	Description
341224	Adult Spread 7-1/2" (19 cm) Blades 1-5/8" deep x 2-5/8" wide (4.1 x 6.7 cm) and 2-1/2" deep x 2-5/8" wide (6.3 x 6.7 cm) Arms curved 50 degrees

GERBODE-BURFORD ADULT RETRACTOR



Stainless steel. The lugs and springs holding the detachable blades in place are located on the underside of the spreader arms. This presents a smooth projection-free upper surface which will not catch sutures. Shanks are curved to fit body contour and blades are detachable. Two pairs of blades are supplied.

Catalog #	Description
341170	Adult Spread 7-1/2" (19 cm) 2-1/8" deep x 2-5/8" wide (5.5 x 6.7 cm) and 2-7/8" deep x 2-5/8" wide (7.3 x 6.7 cm) Arm length 7-1/4" (18.4 cm)

CVT RETRACTORS

Sternal Retractors/Rib Spreaders

GERBODE STERNAL RETRACTORS



Designed to provide retraction on a broad segment of sternum, thus preventing pressure on soft tissues. Sternal fracture from the retractor is less likely to occur. The blades are of simple, smooth construction without protuberances to catch sutures. Blades are designed to place pressure on sternum but not on overlying soft tissue.

Catalog #	Description
341180	Standard spread Spread 5-7/8" (15 cm) Blades 1-3/16" deep x 3-15/16" wide (3 x 10 cm)
341181	Wide spread Spread 7-3/4" (19.5 cm) Blades 1-3/16" deep x 3-15/16" wide (3 x 10 cm)



CVT RETRACTORS

Sternal Retractors/Rib Spreaders

TRANSPLANT DONOR STERNAL RETRACTORS



341387



341389

Each Morse-Style Sternal Retractor blade has a prominent lip and a large spike to secure retractor in donor's sternum for maximum spread without slippage.

Catalog #	Description
341387	Infant/Child Spread 4-3/8" (11 cm) Spiked blades 5/8" deep x 1/2" wide (1.4 x 1.3 cm)
341389	Adult Spread 7-1/2" (19 cm) Spiked blades 1-1/4" deep x 1" wide (3.2 x 2.5 cm)

HEITMILLER MINI THORACOTOMY RETRACTOR



341310

This retractor provides excellent exposure for video-assisted thoracoscopy, open lung biopsies, transaxillary incisions and mid-CAB procedures in which mini-thoracotomy incisions are used. With its small "footprint," it also is ideal for mobilizing lung adhesions during redo thoracotomies.

Catalog #	Description
341310	Spread 3-1/8" (7.9 cm) Blades 5/8" wide (1.6 cm)

CVT RETRACTORS

. Sternal Retractor and Rib Spreader Dimensions

All dimensions are in centimeters. All dimensions are approximate.

age	Catalog #	Blade style	MiniMuM spread	Blade Depth	Blade Width	arm length
PREMIE						
Preemie	341312	Rib, Single, Fixed	4.0	0.8	0.65	2.5
NEWBORN						
Finocchio	341326	Rib, Single, Fixed	4.9	1.5	1.5	5.5
Amato	341303	Sternal, 4 Swivel Blades	7.0	1.0	1.0	4.0
INFANT TO YOUNG CHILDREN						
Aluminum Finocchio	341302	Rib, Single, Fixed	7.0	1.3	1.5	5.5
Amato Medium	341304	Sternal, 4 Swivel Blades	7.0	1.4	1.3	5.9
Amato Large	341305	Sternal, 6 Swivel Blades	7.0	1.4	1.3	9.0
Davis-Finocchio	341290	Rib, Single, Fixed	7.0	1.3	1.5	5.0
DeBakey®-Finocchio	341315	Rib, Single, Fixed	7.0	2.2	2.1	6.0
Replug	341205	Sternal, 4 Swivel Blades	7.5	1.6	1.3	15.0
Aluminum DeBakey®	341317	Rib, Single, Fixed	9.5	3.0	3.0	8.0
Morse	341158	Sternal, 4 Swivel Blades	10.0	1.1	1.5	9.0
Transplant Donor	341387	Sternal, 4 Swivel, Spiked	11.0	1.4	1.3	9.5
Haight Large	341296	Rib, Single, Fixed	12.1	3.4	3.0	9.0
OLDER CHILD 6-10 YEARS						
DeBakey®	341178	Rib, Single, Interchangeable	10.0	3.2	3.0	8.0
Burford-Finocchio	341250	Rib, Single, Interchangeable	15.0	2.5	2.4	10.8
Morse	341160	Sternal, 4 Swivel Blades	15.2	1.6	2.1	12.7
ADOLESCENT						
Kuyper-Murphy Small	341397	Sternal, Fixed	11.5	3.0	9.0	13.5
Finocchio	341328	Rib, Single, Fixed	13.0	3.8	4.4	13.3
MIXED						
Gerbode-Burford	341200	Rib, Single, 4 Interchangeable Blades	15.0	1.9	2.5	11.5
SMALL ADULT						
Rienhoff	341366	Rib, Single, Fixed	14.0	5.0	4.4	11.7
DeBakey®	341177	Rib/Sternal, Interchangeable	14.0	3.2	3.0	13.0
Rienhoff Medium	341362	Rib, Single, Fixed	15.0	3.0	3.3	9.0
Tuffier	341390	Rib, Single, Fixed	15.0	5.6	4.8	11.4
Kuyper-Murphy Medium	341398	Sternal, Fixed	16.0	3.0	8.9	16.0

CVT RETRACTORS

. Sternal Retractor and Rib Spreader Dimensions

All dimensions are in centimeters. All dimensions are approximate.

Age	Catalog #	Blade style	Minimum spread	Blade Depth	Blade Width	arm length
ADULT						
Gerbode	341180	Sternal, Fixed	15.0	3.0	10.0	23.0
Cooley	341194	Sternal, Fixed	16.5	3.2	5.7	14.6
Aluminum Burford	341227	Rib, Single, Interchangeable	17.5	4.7	6.1	19.4
DeBakey	341175	Rib/Sternal, Interchangeable	18.5	3.2	5.7	18.0
Finochietto	341330	Rib, Single, Fixed	19.0	5.4	6.7	15.0
Burford	341225	Rib, Single, Interchangeable	19.0	5.4	6.2	19.5
Gerbode-Burford	341170	Rib, Single, Interchangeable	19.0	5.5	6.7	18.4
Farrell Rubio	341224	Rib/Sternal, Interchangeable	19.0	4.1	6.7	17.0
Adult Transplant Donor	341389	Sternal, Fixed, Spiked	19.0	3.2	2.5	15.0
Morse	341162	Sternal, 4 Swivel Blades	20.3	2.4	2.9	15.2
Favaloro-Morse	341163	Sternal, 4 Swivel Blades	20.3	3.8	2.8	15.2
Chaux	341150	Sternal/IMA, 4 Swivel Blade	20.3	3.7	2.7	20.0
Chaux-Lemole	341155	Sternal/IMA, 4 Swivel Blade, Valve Retractors	23.2	3.0	2.7	20.0
LARGE ADULT						
Cooley	341195	Sternal, Fixed	16.0	3.2	10.2	16.5
Bonchek-Carpentier	341198	Sternal, Fixed	18.5	3.2	10.0	16.0
Finochietto Large	341332	Rib, Single, Fixed	19.0	7.3	6.7	18.0
Gerbode	341181	Sternal, Fixed	19.5	3.0	10.0	23.0
Favaloro-Morse	341164	Sternal, 4 Swivel Blades	20.3	3.8	2.9	20.3

CVT RETRACTORS

Sternal Closure

.-WOLVEK STERNAL APPROXIMATION AND FIXATION SYSTEM



342000

The Wolvek System with its unique suture locking device affords positive, secure sternal approximation and elimination of the problems associated with twisted wire.

Low Profile Stainless Steel Locking Plate:

- Eliminates need for twisting wire.
- More secure closure, at least twice the tensile strength of twisted wire.
- Greater patient comfort.
- Eliminates chance of wire breakage associated with twisting action.
- Less chance of skin perforation.

Sternal Approximator:

- Allows constant tension to be applied as each wire is tightened and locked.
- Provides rigid fixation which will lessen the motion between the edges of the sternum, hasten healing and provide more patient comfort.



342002

Complete P-W Approximator and Fixation System includes 1 Approximator, 1 Locking Plate Crimper, 1 Wire Cutter, Stainless Steel Storage and Case and 1 box 342006.



342004



342006



142550

Catalog #	Description
342000	Complete .-Wolvek Approximator and Fixation System Includes: 1 Approximator, 1 Locking Plate Crimper, 1 Wire Cutter, Stainless Steel Storage and Case and 1 box 342006 (Locking Plates). Sternal Approximator Locking Plate Crimper Locking Plates (suture not included) 8 plates per package (10 packages per box). Only the following sternal sutures and needles should be used with locking plates. Deknatel® Product No. 29-7271M4 Ethicon Product No. M650
342002	The suture wire supplied by these manufacturers is manufactured from type 316L stainless steel as are the locking plates. Suture wire of unknown origin or type may not be metallurgically compatible with the locking plates.
342004	. Stainless Steel Wire Cutter, 6-7/8" (17.5 cm)
342006	Berry Sternal Needle Holder, 7-3/4" (19.5 cm), TC Stainless Steel Storage and Case for System, 15" x 10-1/2" x 2"

CVT RETRACTORS

Sternal Closure

KIRKLIN STERNAL AWLS



342043



342044

For use in wiring the sternum. Wrench included.

Catalog #	Description
342043	Working length 2" (5 cm), 7-1/8" (18 cm)
342044	Needle only for Kirklin awl, 2-3/4" (7 cm)

SWEET MODIFIED STERNAL PUNCH



342040

Perforating blade is hook-shaped to bring suture material back through hole. Dull, non-glare finished stainless steel.

Catalog #	Description
342040	10" (25.5 cm)

Hand-Held

ALLISON LUNG RETRACTORS



341678



341679

Wire, spatula-shaped blade.

Catalog #	Description
341678	Child size, 10-1/4" (26 cm)
341679	Adult Size, 12-3/8" (31.5 cm)

CVT RETRACTORS

Hand-Held

CUSHING DECOMPRESSION RETRACTOR



Catalog #	Description
481220	21 x 10 mm blade, 8-1/8" (20.5 cm)

CUSHING NERVE AND VEIN RETRACTOR



. Pattern, satin finish.

Catalog #	Description
164865	12 mm wide blade, 8-1/2" (21.5 cm)

CUSHING NERVE AND VEIN RETRACTORS



Weck® Pattern, bright finish.

Catalog #	Description
481230	16 x 15 mm blade, 8-5/8" (22 cm)
481231	14.5 x 15 mm blade, 12-3/4" (32.5 cm)

CVT RETRACTORS

Hand-Held

DAVIDSON SCAPULA RETRACTORS



Catalog #	Description
341650	Small size, blade 2" (5 cm) wide, 7-3/4" (19.5 cm)
341651	Large size, blade 3-1/2" (9 cm) wide, 7-3/4" (19.5 cm)

HAIGHT RETRACTORS



Malleable "T"-shaped blades. For abdominal and intra-thoracic surgery.

Catalog #	Description
341690	3" wide x 11-1/2" long (7.5 x 29 cm)
341692	3-1/2" wide x 11-3/4" long (9 x 30 cm)
341694	4" wide x 12" long (10 x 30.5 cm)
341696	4-3/4" wide x 12-3/4" long (12 x 32.5 cm)
341698	5-1/2" wide x 13-1/2" long (14 x 34.5 cm)

CVT RETRACTORS

Hand-Held

ROOS BRACHIAL PLEXUS ROOT RETRACTOR



341992

Designed to protect the T-1 cervical root from trauma by the rib shears or other instruments during posterior resection of the first rib. 14-1/4" (36 cm) length, 10" (25.5 cm) working length.

Catalog #	Description
341992	Angled, 13.5 mm wide blade

WYLIE RENAL VEIN RETRACTORS



341795

Designed for the retraction of the left renal vein during procedures on the abdominal aorta or renal arteries. Gently curved distal tip for atraumatic control. Stainless steel.



341797

Catalog #	Description
341795	Short, 1" wide x 3-3/4" deep (2.5 x 9.5 cm) blade, 11-3/4" (30 cm)
341797	Long, 1" wide x 6-7/8" deep (2.5 x 17.5 cm) blade, 12-3/4" (32.5 cm)

CVT RETRACTORS

Henly-Type Retractors

MULTIPURPOSE RETRACTORS



351666
351667
351668

351669
351670
351671



351675



351784

A versatile, self-retaining Henly-type retractor designed for use in the following surgical specialties: peripheral vascular surgery in the carotid, subclavian, femoral, popliteal and tibial regions. Spinal surgery in the cervical and lumbar regions. Orthopedic surgery in shoulder and hip procedures. General surgery for inguinal hernia, appendectomy and many minor procedures.

Catalog #	Description
351666	Side blade 1-1/8" x 7/8" (3 x 2 cm) for 351675
351667	Side blade 2-1/8" x 7/8" (5.5 x 2 cm) for 351675
351668	Side blade 3-1/8" x 7/8" (8 x 2 cm) for 351675
351669	Center blade, 7/8" x 5/8" (2 x 1.5 cm) for 351675
351670	Center blade, 1-1/8" x 5/8" (3 x 1.5 cm) for 351675
351671	Center blade, 1-1/4" x 5/8" (3 x 1.5 cm) for 351675
351672	Center blade, 2" x 5/8" (5 x 1.5 cm) for 351675
351673	Center blade, 2-1/2" x 5/8" (6.5 x 1.5 cm) for 351675

. Multipurpose Retractor, complete with:

- 1 Frame with 3-1/8" (7.8 cm) spread
- 3 Center Blades in sizes 7/8" (2.2 cm), 1-1/8" and 3-1/8" (8.0 cm) deep x 7/8" (2.2 cm) wide
- Self-retaining, with interchangeable center and side blades. Ball-snap attachment of side blades. Swivel side blades rotate 360 degrees.

351675

351784	Two Extra Long Center Blades Sizes 1-1/2" (3.8 cm) and 1-3/4" (4.5 cm) deep x 5/8" (1.6 cm) wide Fits all Henly and Multipurpose Retractors
--------	---------------------------------------------------------------------------------------------------------------------------------------------------

CVT RETRACTORS

Henly-Type Retractors

IMPROVED HENLY RETRACTORS



351679

With interchangeable center blades and side blades.

Catalog #	Description
351679	Henly Retractor with straight arms, side blades slide onto arms, complete with blades Henly Retractor with arms spread outward. Both are complete with: 1 Frame 3 Center Blades in size 3/4" (2.2 cm), 1" (2.5 cm), 1-1/4" (3.2 cm) deep x 5/8" (16 mm) wide
351680	1 Pair Side Blades, blunt prongs, 7/8" (2.2 cm) wide by 2" (5.1 cm) deep 1 Pair Side Blades, blunt prongs, 7/8" (2.2 cm) wide by 3" (7.6 cm) deep



351680

IMPROVED HENLY RETRACTOR SIDE BLADES



341676

Shallow, medium and deep interchangeable sliding side blades.

Catalog #	Description
351676	1 pair, 1" x 7/8" (2.5 x 2 cm)
351677	1 pair, 2" x 7/8" (5 x 2 cm)
351678	1 pair, 3" x 7/8" (7.5 x 2 cm)

CVT RETRACTORS

Henly-Type Retractors

MAINI SIDE BLADE FOR IMPROVED HENLY RETRACTOR



351661

Catalog #	Description
351661	2-3/4 x 2" (7 X 5 cm), slide-on

MAINI RICHARDSON DOUBLE-ENDED CENTER BLADE FOR HENLY RETRACTOR



351664

Catalog #	Description
351664	Blade ends are 31 mm and 40 mm wide

ORIGINAL HENLY POPLITEAL RETRACTOR



351779

A modification of the Weitlaner Retractor with provisions for attachment of a third retractor blade for improved exposure in either the popliteal or carotid positions. Supplied with 3 center blades. The retraction surfaces of the center blades are grooved for soft tissue retraction.

Catalog #	Description
351779	4 x 3 prongs, center blades: 5/8" wide x 3/4" deep (1.5 x 2 cm), 5/8" wide x 1" deep (1.5 x 2.5 cm), 5/8" wide x 1-1/4" deep (1.5 x 3 cm), overall length 6-3/8" (16 cm)

RETRACTORS, HAND-HELD

RETRACTORS, HAND-HELD

Skin Hooks

CONVERSE SKIN HOOKS



442147

Catalog #
442147
442145

Description
Small, 7-1/4" (18.5 cm)
Large, 7" (18 cm)

COTTLE SKIN HOOKS



054135

Catalog #
054120
054135

Description
Sharp, 2 prongs, 12 mm between prongs,
5-7/8" (15 cm)
Sharp, 3.5 mm hook, 4-7/8" (12.5 cm)



054120

FLEXIBLE RAKE RETRACTOR SKIN HOOKS



GS52182

Catalog #
GS52174
GS52176
GS52182
GS52184
GS52188
GS52192

Description
Sharp, 1 prong, 6-1/4" (16 cm)
Sharp, 2 prongs, 6-1/4" (16 cm)
Sharp, 3 prongs, 6-1/4" (16 cm)
Blunt, 1 prong, 6-1/4" (16 cm)
Blunt, 2 prongs, 6-1/4" (16 cm)
Blunt, 3 prongs, 6-1/4" (16 cm)

FOMON RETRACTOR



054500

Catalog #
054500

Description
Ball tip, 2 prongs, 10 mm between prongs,
6-3/8" (16 cm)

RETRACTORS, HAND-HELD

Skin Hooks

FREER RETRACTOR



481175

Catalog #
481175

Description
Sharp, 2 prongs, 5-7/8" (15 cm)

FREER SKIN HOOK



GS52040

Catalog #
GS52040

Description
Sharp, 2 prongs, 2.5 mm wide, 6" (15 cm)

GILLIES CONVERSE SKIN HOOKS



054130

Catalog #
054128
054130

Description
Small, sharp, 3 mm hook, 7-3/8" (18.5 cm)
Large, sharp, 4 mm hook, 7-1/8" (18 cm)

GUTHRIE SKIN HOOK

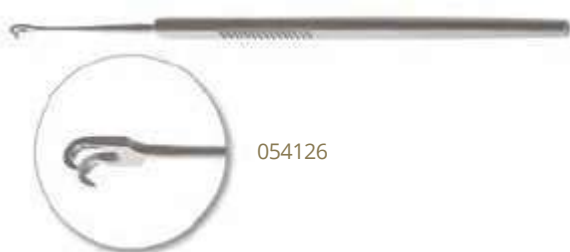

054126

Catalog #
054126

Description
Sharp, 2 prongs, 2 mm between prongs,
5-1/8" (13 cm)

RETRACTORS, HAND-HELD

Skin Hooks

JOHNSON SKIN HOOK



054125

Catalog #
054125

Description
Sharp, 5 mm hook, 6-1/2" (16.5 cm)

JOSEPH SKIN HOOKS



054105

Sharp, 4 mm hook. Weck® Pattern, bright finish.

Catalog #
054100
054102
054105
054107
054110

Description
1 prong, 6-1/8" (15.5 cm)
2 prongs, 2 mm between prongs, 6-1/4" (16 cm)
2 prongs, 5 mm between prongs, 6-1/4" (16 cm)
2 prongs, 6 mm between prongs, 6-1/4" (16 cm)
2 prongs, 9 mm between prongs, 6-1/8" (15.5 cm)

JOSEPH SKIN HOOKS



442104

Pattern, bright finish. 6-1/4" (16 cm).

Catalog #
442100
442102
442104
442106
442108

Description
1 prong
2 prongs, 3 mm
2 prongs, 5.5 mm
2 prongs, 7 mm
2 prongs, 10 mm

KLEINERT-KUTZ SKIN HOOKS



054142

Weck® Pattern, bright finish.

Catalog #
054140
054142
054144

Description
Small, 3 mm hook, 6-1/4" (16 cm)
Medium, 5 mm hook, 6-1/4" (16 cm)
Large, 7 mm hook, 6-1/8" (15.5 cm)

RETRACTORS, HAND-HELD

Skin Hooks

KLEINERT-KUTZ HOOK



GS52060

Pattern, satin finish.

Catalog #	Description
GS52060	3 mm hook, 6-1/4" (16 cm)
GS52064	5 mm hook, 6-1/4" (16 cm)
GS52068	6 mm hook, 6-1/4" (16 cm)

SKIN HOOK



GS52055

Catalog #	Description
GS52055	1 sharp prong, 2 mm hook, 4-3/4" (12 cm)

O'CONNER SKIN HOOK



164786

Catalog #	Description
164786	Sharp, 5-3/8" (13.5 cm)

PECK-JOSEPH SKIN HOOK



442110

Catalog #	Description
442110	2 prongs, 10 mm between prongs, 5-5/8" (14.5 cm)

RIGID RAKE RETRACTOR SKIN HOOKS



GS52172

6-1/2" (16.5 cm).

Catalog #	Description
GS52156	Sharp, 1 prong
GS52158	Sharp, 2 prongs, 6-1/2" (16.5 cm)
GS52162	Sharp, 3 prongs, 6-1/2" (16.5 cm)
GS52164	Blunt, 1 prong, 6-1/2" (16.5 cm)
GS52166	Blunt, 2 prongs, 6-1/2" (16.5 cm)
GS52172	Blunt, 3 prongs, 6-1/2" (16.5 cm)

RETRACTORS, HAND-HELD

Skin Hooks

ROLLET RETRACTOR



481180

Catalog #
481180

Description
Sharp, 4 prongs, 2.8 x 5.5 mm, 5-1/4" (13.5 cm)

SCHNITMAN SHARP SKIN HOOK WITH EYE



524230

Catalog #
524230

Description
6-1/2" (16.5 cm)

TYRELL HOOKS



GS54342

Catalog #
GS54338
GS54342

Description
1 sharp prong, 5" (12.5 cm)
1 blunt prong, 5" (12.5 cm)

TYRELL HOOKS



054015

Delicate, 1.3 mm hook, 4-3/4" (12 cm).

Catalog #
054015
054016

Description
Sharp
Blunt

WIENER SKIN HOOKS



GS54346

Single hook, 5" (12.5 cm).

Catalog #
GS54346
GS54348

Description
Sharp
Blunt

RETRACTORS, HAND-HELD

Hook and Rake Retractors

DANDY NERVE HOOK

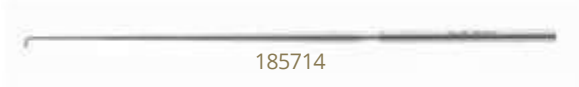

Catalog #
185714

Description
Straight, 5.1 mm hook, 9" (23 cm)

SISSON NERVE HOOK

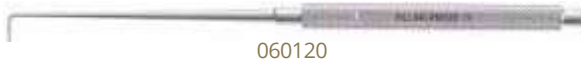

060120

Catalog #
060120

Description
Blunt, 90 degree angled, 7 mm hook,
6-1/8" (15.5 cm)

JACKSON TRACHEAL TENACULUM



514413

Catalog #
514413

Description
Hook depth 1/4" (0.5 cm), 5-1/4" (13.5 cm)

NEWS TRACHEA RETRACTOR

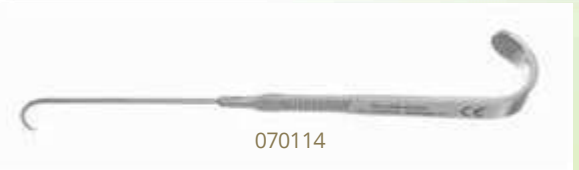

070114

Catalog #
070114

Description
Sharp, 10 mm hook, 5-7/8" (15 cm)

RETRACTORS, HAND-HELD

Hook and Rake Retractors

TRACHEA HOOK



054165

Catalog #
054165
GS52098

Description
Sharp, 8.7 x 1.4 mm hook, 7-1/2" (19 cm)
Hupp Trachea Hook, sharp, 6-1/2" (16.5 cm)

SOLVAY SPAY HOOK



801886

Catalog #
801886

Description
8" (20.5 cm)

JACKSON TRACHEAL RETRACTOR, DOUBLE-ENDED



514414

Pattern, satin finish.

Catalog #
514414

Description
Double-pronged, 1" wide x 1/4" deep
(2.5 cm x 0.5 cm) blade, 6-7/8" (17.5 cm)

RETRACTORS, HAND-HELD

Hook and Rake Retractors

JACKSON TRACHEA RETRACTOR



Weck® Pattern, bright finish.

Catalog #	Description
070116	2 prongs, 7" (18 cm)

DINGMAN ZYGOMA HOOK



Catalog #	Description
026275	Sharp, 13 mm hook, 7" (18 cm)

BERNAY FINGER RAKE TRACHEAL RETRACTORS



Catalog #	Description
514430	1 prong, sharp, 6-5/8" (17 cm)
514431	2 prongs, sharp, 6-5/8" (17 cm)
514433	3 prongs, sharp, 6-5/8" (17 cm)
514435	1 prong, blunt, 6-5/8" (17 cm)
514436	2 prongs, blunt, 6-5/8" (17 cm)
514437	3 prongs, blunt, 6-5/8" (17 cm)
514438	4 prongs, blunt, 6-5/8" (17 cm)

LAHEY FINGER RETRACTORS



Catalog #	Description
GS52082	1 prong, 4-3/4" (12 cm)
GS52086	2 sharp prongs, 5" (12.5 cm)
GS52087	3 sharp prongs, 5" (12.5 cm)

RETRACTORS, HAND-HELD

Hook and Rake Retractors

BLAIR (ROLLET) RETRACTOR



GS54368

Catalog #

GS54366

GS54368

GS54372

Description

Rigid, 4 sharp prongs, 6 mm wide blade, 5" (12.5 cm)

Rigid, 4 blunt prongs, 5 mm wide blade, 5" (12.5 cm)

Flexible, 4 sharp prongs, 5-1/2" (14 cm)

MURPHY RAKE RETRACTORS



164444

Catalog #

164443

164444

164446

164453

164454

164456

Description

Sharp, 3 prongs, 7-3/4" (19.5 cm)

Sharp, 4 prongs, 8" (20.5 cm)

Sharp, 6 prongs, 7-7/8" (20 cm)

Blunt, 3 prongs, 8" (20.5 cm)

Blunt, 4 prongs, 8" (20.5 cm)

Blunt, 6 prongs, 7-3/4" (19.5 cm)



164454

VOLGSANN POCKET RETRACTORS



164374

Catalog #

164374

164376

164384

Description

Sharp, 4 prongs, 4-1/2" (11.5 cm)

Sharp, 6 prongs, 4-1/2" (11.5 cm)

Blunt, 4 prongs, 4-1/2" (11.5 cm)

RETRACTORS, HAND-HELD

Hook and Rake Retractors

VOLGSANN RAKE RETRACTORS



164403



164414

Pattern, satin finish.

Catalog #	Description
164402	Sharp, 2 prongs, 8-1/2" (21.5 cm)
164403	Sharp, 3 prongs, 8-1/2" (21.5 cm)
164404	Sharp, 4 prongs, 8-1/2" (21.5 cm)
164406	Sharp, 6 prongs, 8-1/2" (21.5 cm)
164412	Blunt, 2 prongs, 8-1/2" (21.5 cm)
164413	Blunt, 3 prongs, 8-1/2" (21.5 cm)
164414	Blunt, 4 prongs, 8-1/2" (21.5 cm)
164416	Blunt, 6 prongs, 8-1/2" (21.5 cm)

VOLGSANN RETRACTORS



GS52264

Catalog #	Description
GS52266	6 prongs, 1-1/8" wide x 1/2" deep blade (3 x 1.5 cm), 8-1/2" (21.5 cm)
GS52254	1 prong, 1/2" deep blade (15 mm), 8-1/2" (21.5 cm)
GS52264	4 prongs, 3/4" wide x 1/2" deep blade (18 x 13 mm), 8-1/2" (21.5 cm)

MUELLER RAKE RETRACTOR



GS52338

Catalog #	Description
GS52338	8 prongs, 1-1/2" (38 mm) wide

DEEP RAKE RETRACTORS



GS52294

Catalog #	Description
GS52292	4 blunt prongs, 2-1/4" wide x 1-1/2" deep (5.5 x 4 cm)
GS52294	4 blunt prongs, 2-1/4" wide x 2" deep (5.5 x 5 cm)
GS52296	4 blunt prongs, 2-1/4" wide x 2-1/2" deep (5.5 x 6.5 cm)
GS52298	4 blunt prongs, 2-1/4" wide x 3" deep (5.5 x 7.5 cm)

RETRACTORS, HAND-HELD

Hook and Rake Retractors

ISRAEL RETRACTOR



Catalog #
481390

Description
Blunt, 4 prongs, 41 x 43 mm, 7-3/8" (18.5 cm)

OLLIER RAKE RETRACTOR



Catalog #
GS52282

Description
4 blunt prongs, 5.5 cm wide x 4 cm deep blade,
9" (23 cm)

FREEMAN FACE LIFT RETRACTOR



Catalog #
442295

Description
1-5/8" (4 cm) wide blade, 7-1/8" (18 cm)

RETRACTORS, HAND-HELD

Single-Ended Retractors

BREWSTER RETRACTORS



Curved, convex blades.

Catalog#	Description
164650	3/4" x 1-3/4" (2 x 4.5 cm) blade, 8-1/2" (21.5 cm)
164652	1" x 2" (2.5 x 5 cm) blade, 9" (23 cm)
164656	1-3/4" x 2-1/2" (4.5 x 6.5 cm) blade, 9-1/4" (23.5 cm)
164658	1-7/8" x 2-7/8" (5 x 7.5 cm) blade, 9-1/2" (24 cm)

COTTLE ALAR RETRACTOR



Catalog#	Description
442210	1/2" (1.5 cm) wide blade, 5-1/2" (14 cm)

CUSHING DECOMPRESSION RETRACTOR



Catalog#	Description
481220	21 x 10 mm blade, 8-1/8" (20.5 cm)

RETRACTORS, HAND-HELD

Single-Ended Retractors

CUSHING NERVE AND VEIN RETRACTOR



164865

Pattern, satin finish.

Catalog #	Description
164865	12 mm wide blade, 8-1/2" (21.5 cm)

CUSHING NERVE AND VEIN RETRACTORS



481230

Weck® Pattern, bright finish.

Catalog #	Description
481230	16 x 15 mm blade, 8-5/8" (22 cm)
481231	14.5 x 15 mm blade, 12-3/4" (32.5 cm)

DESMARRES LID RETRACTORS



421630

Catalog #	Description
421610	Size 1, 12 mm wide blade, 5-3/8" (13.5 cm)
421620	Size 2, 13 mm wide blade, 5-3/8" (13.5 cm)
421630	Size 3, 15 mm wide blade, 5-3/8" (13.5 cm)
421640	Size 4, 17 mm wide blade, 5-3/8" (13.5 cm)

GREEN RETRACTOR



481520

Catalog #	Description
481520	Fenestrated, 21 x 24 mm blade, 8-7/8" (22.5 cm)

RETRACTORS, HAND-HELD

Single-Ended Retractors

LAHEY RETRACTOR



Catalog #	Description
481610	30 x 5 mm blade, 7-3/4" (19.5 cm)

LANGENBECK RETRACTORS



Distal blade tip, slightly curved. Flat handle.
Length 8-1/2" (21.5 cm).

Catalog #	Description
164630	3/8" x 1-5/8" (1 x 4 cm) blade
164631	1/2" x 1-5/8" (1.3 x 4 cm) blade
164632	5/8" x 1-5/8" (1.5 x 4 cm) blade

LITTLER RETRACTOR



Catalog #	Description
481500	Curved, 20 x 12 mm blade, 7-1/2" (19 cm)

RETRACTORS, HAND-HELD

Single-Ended Retractors

LOVE NERVE RETRACTORS



GS51532

Catalog #	Description
GS51530	Straight, 7 mm wide blade, 8-1/2" (21.5 cm)
GS51532	Angled 45 degrees, 7 mm wide blade, 7" (18 cm)
GS51534	Angled 90 degrees

LOVE NERVE RETRACTORS



481250

Catalog #	Description
481250	4 x 6 mm blade, straight, 8" (20.5 cm)

MCBURNEY RETRACTOR



481530

Catalog #	Description
481530	Fenestrated, 20 x 16 mm blade, 7-5/8" (19.5 cm)

RETRACTORS, HAND-HELD

Single-Ended Retractors

MEYERDING FINGER RETRACTORS



164790

Pattern, satin finish.

Catalog #	Description
164790	7.5 x 17 mm blade, 6-7/8" (17.5 cm)

MEYERDING FINGER RETRACTORS



GS52116

Pattern, satin finish, 7" (18 cm).



GS52122

Catalog #	Description
GS52116	#1, 7 mm wide x 18 mm deep blade
GS52118	#2, 6 mm wide x 17 mm deep blade, with teeth
GS52122	#3, 4 mm wide x 8 mm deep blade, with teeth
GS52124	#4, 4 mm wide x 10 mm deep blade
GS52128	#5, 4 mm wide x 7 mm deep blade
GS52130	#6, 8 mm wide x 7 mm deep blade, 3 sharp prongs



GS52128



GS52130

RETRACTORS, HAND-HELD

Single-Ended Retractors

SAUERBRUCH RETRACTORS



Long, slender blades with slightly curved tips.
Hollow handle.

Catalog #	Description
164635	5/8" x 1-3/4" (1.5 x 4.5 cm) blade, 9" (23 cm)
164636	7/8" x 2-1/2" (2 x 6.5 cm) blade, 9" (23 cm)
164637	3/4" x 2-7/8" (2 x 7.5 cm) blade, 8-7/8" (22.5 cm)

SEMB RETRACTOR



For retracting the muscles during resection of the posterior medial ends of the ribs and during freeing of the transverse processes and separation of the vertebrocostal joints. Stainless steel blade.

Catalog #	Description
341640	Small, blade 3/4" wide x 1-3/4" deep (2 x 4.5 cm)

Double-Ended Retractors

"S" RETRACTOR



Catalog #	Description
054620	Blade A 1/4" wide x 3/8" deep (6 x 10 mm), Blade B 1/2" wide x 5/8" deep (13.5 x 15 mm) Overall length 5-1/4" (13.5 cm)

RETRACTORS, HAND-HELD

Double-Ended Retractors

KLEINERT-RAGNELL RETRACTOR



Catalog #
442260

Description
Blade A 1/4" wide x 3/4" deep (5.6 x 20 mm),
Blade B 1/8" wide x 3/8" deep (3.7 x 10 mm),
Overall length 6-1/8" (15.5 cm)

BREWSTER PHRENIC RETRACTORS



Nested set of 2.

Catalog #
341635

Description
Large blade 1-3/8" x 1-1/2" wide (20 x 40 mm) x
1-3/8" deep (35 mm),
Small blade 1" wide x 3/8" deep (25 x 10 mm),
Overall length 5-7/8" (15 cm)

CHILDREN'S HOSPITAL RETRACTOR



Catalog #
164754

Description
Blade A 3/8" wide x 3/4" deep (10 x 19 mm),
Blade B 1/4" wide x 3/4" deep (6 x 19 mm),
Overall length 6-1/8" (15.5 cm)

RETRACTORS, HAND-HELD

Double-Ended Retractors

CRILE RETRACTOR

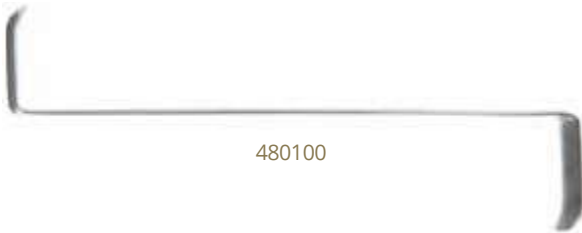

Catalog #
480100

Description
Large blade 1/4" wide x 3/4" deep (7.5 x 20 mm),
Small blade 1/4" wide x 5/8" deep (5 x 17 mm),
Overall length 4-1/8" (10.5 cm)

DAVIS RETRACTORS



Catalog #
442245

Description
Blade A 3/8" wide (10 mm), Blade B 1/4" wide
(6 mm), Overall length 6-1/8" (15.5 cm)

DAVIS RETRACTORS



Catalog #
GS52076

Description
Blade A 1/4" wide x 5/8" deep blade (6 x 17 mm),
Blade B 3/8" wide x 3/4" deep blade (9 x 20 mm),
Overall length 6" (15 cm)

FARABEUF RETRACTORS



Nested set of 2.

Catalog #
164700

Description
Blade A 5/8" wide x 1-1/8" deep (15 x 28 mm),
Blade B 5/8" wide x 1-1/4" deep (15 x 30 mm),
Overall length 6" (15 cm)

164702

Blade A 3/8" wide x 1" deep (10 x 25 mm),
Blade B 1/2" wide x 1-1/4" deep (12 x 30 mm),
Overall length 4-1/2" (11.5 cm)

164702

RETRACTORS, HAND-HELD

Double-Ended Retractors

GOELET RETRACTOR



480150

Catalog #
480150

Description
Blade A 1" wide x 1-1/8" deep (26 x 30 mm),
Blade B 1-1/4" wide x 1-7/8" deep (31 x 47 mm),
Overall length 7-1/2" (19 cm)

INFANT RETRACTOR



480105

Catalog #
480105

Description
Blades 3/8" x 1/2" (10 x 13 mm), 5-5/8" (14.5 cm)

LUKENS THYMUS RETRACTOR



514412

Catalog #
514412

Description
Blade 3/8" wide x 1/4" deep (9 x 6 mm),
Overall length 6-7/8" (17.5 cm)

MAYO-COLLINS RETRACTORS

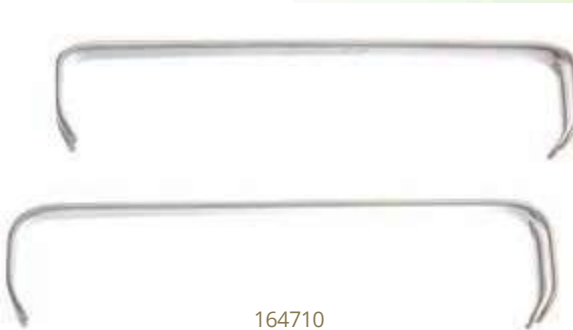

164710

Nested set of 2.

Catalog #
164710

Description
Blade A 3/4" wide x 1-1/8" deep (20 x 30 mm),
Blade B 3/4" wide x 1-1/4" deep (20 x 35 mm),
Overall length 6" (15 cm)

RETRACTORS, HAND-HELD

Double-Ended Retractors

PARKER RETRACTORS

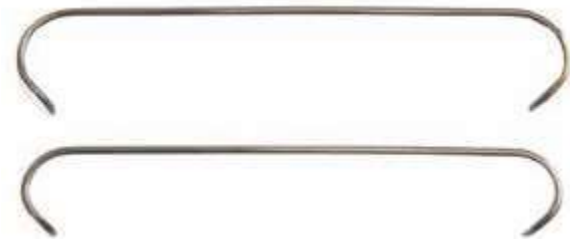

480170

Catalog #

480170

Description

Small set of 2 retractors.

Short retractor: Blade A 7/8" wide x 5/8" deep (21 x 16 mm), Blade B 1" wide x 5/8" deep (25 x 16 mm), Overall length 5-1/2" (14 cm)

Large set of 2 retractors.

Short retractor: Blade A 1" wide x 1" deep (25 x 24 mm), Blade B 1" wide x 1" deep (26 x 24 mm), Overall length 6-3/4" (17 cm)

480172

PARKER-MOTT RETRACTORS



164698

Set of 2.

Catalog #

164698

Description

1" x 2-1/2" (25 x 65 mm) blades,
Overall length 5-3/4" (14.5 cm)

RAGNELL RETRACTOR



054600

Catalog #

054600

Description

Blade A 3 mm wide x 8 mm deep,
Blade B 5 mm wide x 17 mm deep,
Overall length 5-3/4" (14.5 cm)

RETRACTORS, HAND-HELD

Double-Ended Retractors

RAGNELL RETRACTOR



GS52094

Pattern, satin finish.

Catalog #	Description
GS52094	Blade A 4 wide x 8 mm deep, Blade B 6 wide x 15 mm deep, Overall length 5-3/4" (14.5 cm)

ROUX RETRACTORS



480140

7-1/4" (18.5 cm).

Catalog #	Description
480140	Small: Blade A 1-1/8" wide x 1" deep (27 x 25 mm), Blade B 1-3/8" wide x 1-1/2" deep (34 x 38 mm)
480145	Large: Blade A 1-1/4" wide x 1-3/8" deep (31 x 36 mm), Blade B 1-1/4" wide x 1-7/8" deep (31 x 47 mm)



480145

SENN RETRACTORS



164750

Pattern, satin finish. 1/4" x 3/4" (6 x 19 mm) flat blade, 6-1/4" (16 cm).

Catalog #	Description
164750	3 sharp prongs
164752	3 blunt prongs

SENN-KANAHEL DELICATE RETRACTOR



054590

Catalog #	Description
054590	3 sharp 7 x 7 mm prongs, 21 x 6 mm blade, 6-1/2" (16.5 cm)

RETRACTORS, HAND-HELD

Double-Ended Retractors

MILLER-SENN RETRACTORS



9.8 mm prongs, 21 x 6.5 mm blade, 6-1/2" (16.5 cm).

Catalog #	Description
480125	3 sharp prongs
480126	3 blunt prongs

U.S. ARMY (ARMY-NAVY) RETRACTORS



Nested set of 2.

Catalog #	Description
164715	5/8" (1.5 cm) wide blade, 8-1/2" (21.5 cm)

Abdominal-Type Retractors

DEAVER RETRACTORS



Hollow grip handle.

Catalog #	Description
GS51230	1" wide x 10" long blade (2.5 x 25.5 cm)
GS51232	1" wide x 12" long blade (2.5 x 30.5 cm)
GS51234	1" wide x 13" long blade (2.5 x 33 cm)
GS51240	2" wide x 12" long blade (5 x 30.5 mm)
GS51236	2-1/2" wide x 14-1/2" long blade (6.5 x 37 cm)
GS51242	3" wide x 12" long blade (7.5 x 30.5 cm)
GS51238	3-1/2" wide x 12" long blade (9 x 30.5 cm)

RETRACTORS, HAND-HELD

Abdominal-Type Retractors

DEAVER RETRACTORS

Standard design. Rigid stainless steel.



164110



164112



164115



164118



164120



164122



164125



164130



164134

Catalog #	Description
164110	3/4" (2 cm) wide, 6-7/8" (17.5 cm)
164112	7/8" (2 cm) wide, 7-7/8" (20 cm)
164115	1" (2.5 cm) wide, 8-7/8" (22.5 cm)
164118	#1, 1" (2.5 cm) wide, 8-1/8" (20.5 cm)
164120	#2, 1" (2.5 cm) wide, 9-7/8" (25 cm)
164122	#3, 1" (2.5 cm) wide, 12" (30.5 cm)
164125	#4, 1" (2.5 cm) wide, 14-3/8" (36.5 cm)
164130	#5, 1-1/2" (4 cm) wide, 11-7/8" (30 cm)
164132	#6, 2" (5 cm) wide, 12" (30.5 cm)
164134	#7, 3" (7.5 cm) wide, 12" (30.5 cm)

RETRACTORS, HAND-HELD

Abdominal-Type Retractors

W.M. LEMMON EXTRA-DEEP DEAVER RETRACTORS



341732

Distal blade section extended to provide working depth of 9-1/2" (24 cm). Blade length 15" (38 cm). Large fluted handles.

Catalog #	Description
341730	1" (2.5 cm) wide blade
341732	2" (5 cm) wide blade

WILLAUER-DEAVER RETRACTORS



341722

Deaver blades mounted on comfortable handle.

Catalog #	Description
341720	Narrow, 1" wide x 6-1/4" deep (2.5 x 16 cm) blade, 14-1/2" (37 cm)
341722	Wide, 2" wide x 6-1/4" deep (5 x 16 cm) blade, 14-1/2" (37 cm)

DEEP DEAVER RETRACTORS



481826

Stainless steel, hollow handle.

Catalog #	Description
481825	6" deep x 1-1/2" (15 x 4 cm) blade, 13-3/4" (35 cm)
481826	6" deep x 2" (15 x 5 cm) blade, 13-3/4" (35 cm)
481827	6" deep x 2-1/2" (15 x 6.5 cm) blade, 13-3/4" (35 cm)

RETRACTORS, HAND-HELD

Abdominal-Type Retractors

DOYEN RETRACTORS



Concave blade.

Catalog #	Description
164520	1-3/4" x 2-3/4" blade (4.5 x 7 cm), 8-3/4" (22 cm)
164521	2-3/8" x 3-3/8" blade (6 x 8.5 cm), 9" (23 cm)
164522	2-1/4" x 3-7/8" blade (5.5 x 10 cm), 9" (23 cm)

DEBAKEY®-COOLEY RETRACTOR



Extra-deep retractor of greater than usual width. Blade is carefully proportioned to provide maximum working depth and to prevent tendency toward slipping upward and out. Satin finish to prevent glare from overhead lights.

Catalog #	Description
341740	7-1/4" (18.5 cm) deep blade with 2-1/4" (5.5 cm) Harrington end, 12-1/4" (31 cm)

HARRINGTON EXTRA DEEP RETRACTORS



Extra-deep with fluted handle, satin finish.

Catalog #	Description
341790	2-1/4" wide x 8" deep blade (5.5 x 20.5 cm), 11-3/4" (30 cm)
341791	4-1/2" wide x 7" deep blade (11.5 x 18 cm), 13-1/8" (33.5 cm)

HARRINGTON RETRACTORS

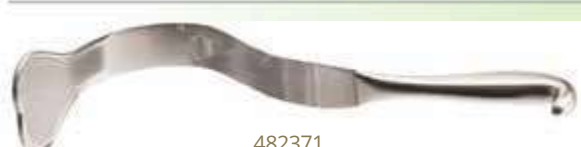

Stainless steel, hollow handle.

Catalog #	Description
482370	135 x 44 mm blade, 12-3/4" (32.5 cm)
482371	135 x 65 mm blade, 13" (33 cm)

RETRACTORS, HAND-HELD

Single-Ended Retractors

SAUERBRUCH RETRACTORS



Long, slender blades with slightly curved tips.
Hollow handle.

Catalog #	Description
164635	5/8" x 1-3/4" (1.5 x 4.5 cm) blade, 9" (23 cm)
164636	7/8" x 2-1/2" (2 x 6.5 cm) blade, 9" (23 cm)
164637	3/4" x 2-7/8" (2 x 7.5 cm) blade, 8-7/8" (22.5 cm)

SEMB RETRACTOR



For retracting the muscles during resection of the posterior medial ends of the ribs and during freeing of the transverse processes and separation of the vertebrocostal joints. Stainless steel blade.

Catalog #	Description
341640	Small, blade 3/4" wide x 1-3/4" deep (2 x 4.5 cm)

Double-Ended Retractors

"S" RETRACTOR



Catalog #	Description
054620	Blade A 1/4" wide x 3/8" deep (6 x 10 mm), Blade B 1/2" wide x 5/8" deep (13.5 x 15 mm) Overall length 5-1/4" (13.5 cm)

RETRACTORS, HAND-HELD

Double-Ended Retractors

KLEINERT-RAGNELL RETRACTOR

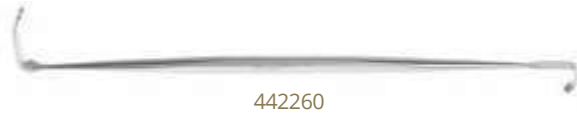

Catalog #
442260

Description
Blade A 1/4" wide x 3/4" deep (5.6 x 20 mm),
Blade B 1/8" wide x 3/8" deep (3.7 x 10 mm),
Overall length 6-1/8" (15.5 cm)

BREWSTER PHRENIC RETRACTORS



Nested set of 2.

Catalog #
341635

Description
Large blade 1-3/8" x 1-1/2" wide (20 x 40 mm) x
1-3/8" deep (35 mm),
Small blade 1" wide x 3/8" deep (25 x 10 mm),
Overall length 5-7/8" (15 cm)

CHILDREN'S HOSPITAL RETRACTOR



Catalog #
164754

Description
Blade A 3/8" wide x 3/4" deep (10 x 19 mm),
Blade B 1/4" wide x 3/4" deep (6 x 19 mm),
Overall length 6-1/8" (15.5 cm)

RETRACTORS, HAND-HELD

Double-Ended Retractors

CRILE RETRACTOR

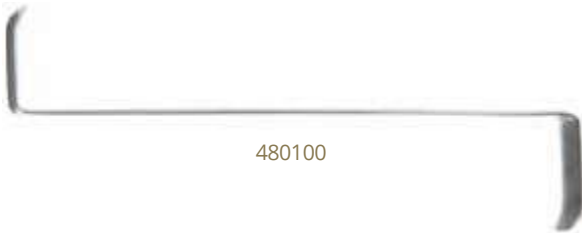

480100

Catalog #
480100

Description
Large blade 1/4" wide x 3/4" deep (7.5 x 20 mm),
Small blade 1/4" wide x 5/8" deep (5 x 17 mm),
Overall length 4-1/8" (10.5 cm)

DAVIS RETRACTORS



442245

Catalog #
442245

Description
Blade A 3/8" wide (10 mm), Blade B 1/4" wide
(6 mm), Overall length 6-1/8" (15.5 cm)

DAVIS RETRACTORS



GS52076

Catalog #
GS52076

Description
Blade A 1/4" wide x 5/8" deep blade (6 x 17 mm),
Blade B 3/8" wide x 3/4" deep blade (9 x 20 mm),
Overall length 6" (15 cm)

FARABEUF RETRACTORS



164702

Nested set of 2.

Catalog #
164700

Description
Blade A 5/8" wide x 1-1/8" deep (15 x 28 mm),
Blade B 5/8" wide x 1-1/4" deep (15 x 30 mm),
Overall length 6" (15 cm)

164702

Blade A 3/8" wide x 1" deep (10 x 25 mm),
Blade B 1/2" wide x 1-1/4" deep (12 x 30 mm),
Overall length 4-1/2" (11.5 cm)

RETRACTORS, HAND-HELD

Double-Ended Retractors

GOELET RETRACTOR



480150

Catalog #
480150

Description
Blade A 1" wide x 1-1/8" deep (26 x 30 mm),
Blade B 1-1/4" wide x 1-7/8" deep (31 x 47 mm),
Overall length 7-1/2" (19 cm)

INFANT RETRACTOR



480105

Catalog #
480105

Description
Blades 3/8" x 1/2" (10 x 13 mm), 5-5/8" (14.5 cm)

LUKENS THYMUS RETRACTOR



514412

Catalog #
514412

Description
Blade 3/8" wide x 1/4" deep (9 x 6 mm),
Overall length 6-7/8" (17.5 cm)

MAYO-COLLINS RETRACTORS



164710

Nested set of 2.

Catalog #
164710

Description
Blade A 3/4" wide x 1-1/8" deep (20 x 30 mm),
Blade B 3/4" wide x 1-1/4" deep (20 x 35 mm),
Overall length 6" (15 cm)

RETRACTORS, HAND-HELD

Double-Ended Retractors

PARKER RETRACTORS

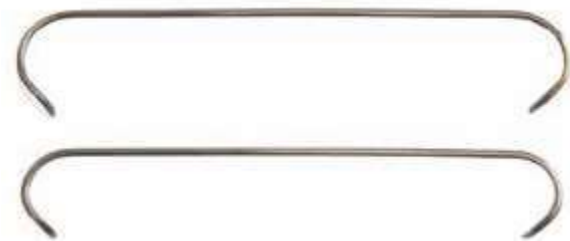

480170

Catalog #

480170

Description

Small set of 2 retractors.

Short retractor: Blade A 7/8" wide x 5/8" deep (21 x 16 mm), Blade B 1" wide x 5/8" deep (25 x 16 mm), Overall length 5-1/2" (14 cm)

Large set of 2 retractors.

480172

Short retractor: Blade A 1" wide x 1" deep (25 x 24 mm), Blade B 1" wide x 1" deep (26 x 24 mm), Overall length 6-3/4" (17 cm)

PARKER-MOTT RETRACTORS



164698

Set of 2.

Catalog #

164698

Description

1" x 2-1/2" (25 x 65 mm) blades,
Overall length 5-3/4" (14.5 cm)

RAGNELL RETRACTOR



054600

Catalog #

054600

Description

Blade A 3 mm wide x 8 mm deep,
Blade B 5 mm wide x 17 mm deep,
Overall length 5-3/4" (14.5 cm)

RETRACTORS, HAND-HELD

Double-Ended Retractors

RAGNELL RETRACTOR



GS52094

Pattern, satin finish.

Catalog #	Description
GS52094	Blade A 4 wide x 8 mm deep, Blade B 6 wide x 15 mm deep, Overall length 5-3/4" (14.5 cm)

ROUX RETRACTORS



480140

7-1/4" (18.5 cm).

Catalog #	Description
480140	Small: Blade A 1-1/8" wide x 1" deep (27 x 25 mm), Blade B 1-3/8" wide x 1-1/2" deep (34 x 38 mm)
480145	Large: Blade A 1-1/4" wide x 1-3/8" deep (31 x 36 mm), Blade B 1-1/4" wide x 1-7/8" deep (31 x 47 mm)



480145

SENN RETRACTORS



164750

Pattern, satin finish. 1/4" x 3/4" (6 x 19 mm) flat blade, 6-1/4" (16 cm).

Catalog #	Description
164750	3 sharp prongs
164752	3 blunt prongs

SENN-KANAHEL DELICATE RETRACTOR



054590

Catalog #	Description
054590	3 sharp 7 x 7 mm prongs, 21 x 6 mm blade, 6-1/2" (16.5 cm)

RETRACTORS, HAND-HELD

Double-Ended Retractors

MILLER-SENN RETRACTORS



9.8 mm prongs, 21 x 6.5 mm blade, 6-1/2" (16.5 cm).

Catalog #	Description
480125	3 sharp prongs
480126	3 blunt prongs

U.S. ARMY (ARMY-NAVY) RETRACTORS



Nested set of 2.

Catalog #	Description
164715	5/8" (1.5 cm) wide blade, 8-1/2" (21.5 cm)

Abdominal-Type Retractors

DEAVER RETRACTORS



Hollow grip handle.

Catalog #	Description
GS51230	1" wide x 10" long blade (2.5 x 25.5 cm)
GS51232	1" wide x 12" long blade (2.5 x 30.5 cm)
GS51234	1" wide x 13" long blade (2.5 x 33 cm)
GS51240	2" wide x 12" long blade (5 x 30.5 mm)
GS51236	2-1/2" wide x 14-1/2" long blade (6.5 x 37 cm)
GS51242	3" wide x 12" long blade (7.5 x 30.5 cm)
GS51238	3-1/2" wide x 12" long blade (9 x 30.5 cm)

RETRACTORS, HAND-HELD

Abdominal-Type Retractors

DEAVER RETRACTORS

Standard design. Rigid stainless steel.



164110



164112



164115



164118



164120



164122



164125



164130



164134

Catalog #	Description
164110	3/4" (2 cm) wide, 6-7/8" (17.5 cm)
164112	7/8" (2 cm) wide, 7-7/8" (20 cm)
164115	1" (2.5 cm) wide, 8-7/8" (22.5 cm)
164118	#1, 1" (2.5 cm) wide, 8-1/8" (20.5 cm)
164120	#2, 1" (2.5 cm) wide, 9-7/8" (25 cm)
164122	#3, 1" (2.5 cm) wide, 12" (30.5 cm)
164125	#4, 1" (2.5 cm) wide, 14-3/8" (36.5 cm)
164130	#5, 1-1/2" (4 cm) wide, 11-7/8" (30 cm)
164132	#6, 2" (5 cm) wide, 12" (30.5 cm)
164134	#7, 3" (7.5 cm) wide, 12" (30.5 cm)

RETRACTORS, HAND-HELD

Abdominal-Type Retractors

W.M. LEMMON EXTRA-DEEP DEAVER RETRACTORS



341732

Distal blade section extended to provide working depth of 9-1/2" (24 cm). Blade length 15" (38 cm). Large fluted handles.

Catalog #	Description
341730	1" (2.5 cm) wide blade
341732	2" (5 cm) wide blade

WILLAUER-DEAVER RETRACTORS



341722

Deaver blades mounted on comfortable handle.

Catalog #	Description
341720	Narrow, 1" wide x 6-1/4" deep (2.5 x 16 cm) blade, 14-1/2" (37 cm)
341722	Wide, 2" wide x 6-1/4" deep (5 x 16 cm) blade, 14-1/2" (37 cm)

DEEP DEAVER RETRACTORS



481826

Stainless steel, hollow handle.

Catalog #	Description
481825	6" deep x 1-1/2" (15 x 4 cm) blade, 13-3/4" (35 cm)
481826	6" deep x 2" (15 x 5 cm) blade, 13-3/4" (35 cm)
481827	6" deep x 2-1/2" (15 x 6.5 cm) blade, 13-3/4" (35 cm)

RETRACTORS, HAND-HELD

Abdominal-Type Retractors

DOYEN RETRACTORS



Concave blade.

Catalog #	Description
164520	1-3/4" x 2-3/4" blade (4.5 x 7 cm), 8-3/4" (22 cm)
164521	2-3/8" x 3-3/8" blade (6 x 8.5 cm), 9" (23 cm)
164522	2-1/4" x 3-7/8" blade (5.5 x 10 cm), 9" (23 cm)

DEBAKEY®-COOLEY RETRACTOR



Extra-deep retractor of greater than usual width. Blade is carefully proportioned to provide maximum working depth and to prevent tendency toward slipping upward and out. Satin finish to prevent glare from overhead lights.

Catalog #	Description
341740	7-1/4" (18.5 cm) deep blade with 2-1/4" (5.5 cm) Harrington end, 12-1/4" (31 cm)

HARRINGTON EXTRA DEEP RETRACTORS



Extra-deep with fluted handle, satin finish.

Catalog #	Description
341790	2-1/4" wide x 8" deep blade (5.5 x 20.5 cm), 11-3/4" (30 cm)
341791	4-1/2" wide x 7" deep blade (11.5 x 18 cm), 13-1/8" (33.5 cm)

HARRINGTON RETRACTORS

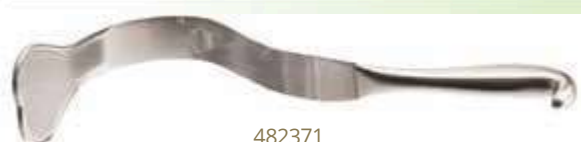

Stainless steel, hollow handle.

Catalog #	Description
482370	135 x 44 mm blade, 12-3/4" (32.5 cm)
482371	135 x 65 mm blade, 13" (33 cm)

RETRACTORS, HAND-HELD

Abdominal-Type Retractors

HARRINGTON SPLANCHNIC RETRACTORS



341773

Catalog #

341770

341773

Cross serrated retracting surface.

Description

1-1/2" wide x 4-3/4" deep blade (4 x 12 cm),
12-1/2" (32 cm)

2-1/2" wide x 5" deep blade (6.5 x 12.5 cm),
12" (30.5 cm)

KELLY RETRACTORS



164526

Flat blade with slight upward turn on sides and
downward turn on slightly reduced width distal edge.

Catalog #

GS51222

164525

164526

164527

164528

Description

3" x 2-1/2" blade (76 x 64 mm), 9-3/4" (25 cm)

1-1/2" x 2" blade (38 x 50 mm), 9" (23 cm)

2" x 2-3/8" blade (50 x 61 mm), 9-1/2" (24 cm)

2-1/2" x 3" blade (64 x 76 mm), 10" (25.5 cm)

3" x 3-1/2" blade (76 x 90 mm), 10-1/2" (26.5 cm)

MAYO ABDOMINAL RETRACTOR



482350

Catalog #

482350

Description

40 x 70 mm blade, 11" (28 cm)

RICHARDSON APPENDECTOMY RETRACTOR



164540

Catalog #

164540

Description

3/4" wide x 2" deep blade (2 x 5 cm), 9-1/2" (24 cm)

RETRACTORS, HAND-HELD

Abdominal-Type Retractors

RICHARDSON RETRACTORS



164543

Blade face is relatively flat with lateral edges curved upwards. Distal edge is straight across and turned downward.

Catalog #	Description
164542	3/4" x 1-1/4" blade (20 x 32 mm), length 9-3/4" (25 cm)
164543	1" x 1-1/4" blade (25 x 32 mm), length 9-3/4" (25 cm)
164544	1-1/2" x 1-1/2" blade (38 x 38 mm), length 9-3/4" (25 cm)

RICHARDSON RETRACTORS



481618

481629

Stainless steel, hollow handle.

Catalog #	Description
481616	1" x 3/4" blade (25 x 20 mm), 9-1/2" (24.5 cm)
481617	1-1/4" x 1-1/4" blade (32 x 32 mm), 9-1/2" (24.5 cm)
481618	1-1/2" x 1-1/2" blade (38 x 38 mm), 9-1/2" (24.5 cm)
481629	2" x 3/4" blade (48 x 20 mm), 9-1/2" (24.5 cm)

RICHARDSON-EASTMAN RETRACTORS



164550

Pattern, satin finish.

Catalog #	Description
164550	Set of 2: Small 10" (25.5 cm), blade A 33 x 30 mm, blade B 26 x 23 mm Large 10-3/4" (27.5 cm), blade A 65 x 43 mm, blade B 42 x 38 mm

RETRACTORS, HAND-HELD

Abdominal-Type Retractors

RICHARDSON-EASTMAN RETRACTORS



Catalog #	Description
480195	Set of 2: Small 9-7/8" (25 cm) blade A 30 x 29 mm, blade B 24 x 22 mm Large 10-5/8" (27 cm) blade A 63 x 42 mm, blade B 39 x 37 mm, Weck® Pattern, bright finish
480196	Small only: 9-7/8" (25 cm) blade A 30 x 29 mm, blade B 24 x 22 mm, Weck® Pattern, bright finish
GS51214	Large only: 10-5/8" (27 cm) blade A 65 x 43 mm, blade B 39 x 38 mm, Satin finish

WYLIE RENAL VEIN RETRACTORS



Designed for the retraction of the left renal vein during procedures on the abdominal aorta or renal arteries. Gently curved distal tip for atraumatic control. Stainless Steel.

Catalog #	Description
341795	Short, 1" wide x 3-3/4" deep (2.5 x 9.5 cm) blade, 11-3/4" (30 cm)
341797	Long, 1" wide x 6-7/8" deep (2.5 x 17.5 cm) blade, 12-3/4" (32.5 cm)

WYLIE SPLANCHNIC RETRACTOR



Catalog #	Description
341780	Rigid, acutely curved blade is 6-3/4" deep (17 cm) Distal 1/2" is angled inward and deeply cross serrated, which provides positive, non-slip traction Blade is 2-1/2" wide (6.3 cm) Large, fluted handle, overall length 13"

RETRACTORS, HAND-HELD

Ribbon-Type Malleable Retractors

DAVIS BRAIN SPATULAS



380206

Catalog #	Description
380200	1/4" (6.5 mm) wide blade
380202	3/8" (9.5 mm) wide blade
380204	1/2" (12.5 mm) wide blade
380206	5/8" (16 mm) wide blade
380208	3/4" (19 mm) wide blade
380210	1" (25.5 mm) wide blade

HAIGHT RETRACTORS



341694

Malleable "T"-shaped blades. For abdominal and intra-thoracic surgery.

Catalog #	Description
341690	3" wide x 11-1/2" long (7.5 x 29 cm)
341692	3-1/2" wide x 11-3/4" long (9 x 30 cm)
341694	4" wide x 12" long (10 x 30.5 cm)
341696	4-3/4" wide x 12-3/4" long (12 x 32.5 cm)
341698	5-1/2" wide x 13-1/2" long (14 x 34.5 cm)

OCHSNER RIBBON RETRACTORS



164170

Malleable.

Catalog #	Description
164164	1" x 13" (2.5 x 33 cm)
164166	1-1/4" x 13" (3 x 33 cm)
164168	1-1/2" x 13" (4 x 33 cm)
164170	2" x 13" (5 x 33 cm)
164172	2-1/2" x 13" (6.5 x 33 cm)
164174	3" x 13" (7.5 x 33 cm)
442288	7/8" x 7" (2 x 18 cm)

RIBBON RETRACTORS



GS51766

Malleable.

Catalog #	Description
GS51752	1/2" (12.5 mm) wide blade, 6" (15 cm)
GS51755	1" (25.5 mm) wide blade, 7-1/2" (19 cm)
GS51766	3/4" (19 mm) wide blade, 13" (33 cm)

RETRACTORS, HAND-HELD

Specialty Retractors

ALLISON LUNG RETRACTORS



341679

Wire, spatula-shaped blade.

Catalog #
341678
341679

Description
Child size, 10-1/4" (26 cm)
Adult Size, 12-3/8" (31.5 cm)

DAVIDSON SCAPULA RETRACTORS



341650

Catalog #
341650
341651

Description
Small size, blade 2" (5 cm) wide, 7-3/4" (19.5 cm)
Large size, blade 3-1/2" (9 cm) wide,
7-3/4" (19.5 cm)

DEVINE-MILLARD-AUFRECHT NASAL RETRACTOR FIBEROPTIC LIGHTING



525150

Catalog #
525150

Description
7-3/4" (19.5 cm)

FACE LIFT RETRACTOR FIBEROPTIC LIGHTING ON #2 DEEVER RETRACTOR



525215

Catalog #
525215

Description
10-5/8" (27 cm)

RETRACTORS, SELF-RETAINING

RETRACTORS, SELF-RETAINING

Wire and Alm-Type Retractors

BARRAQUER WIRE SPECULUMS

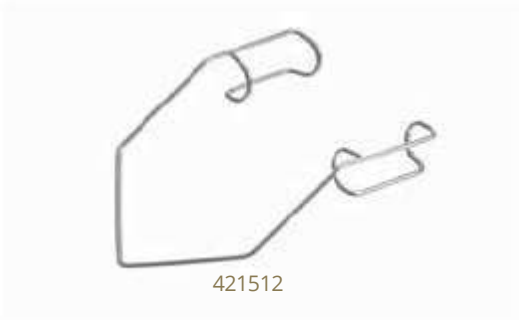

All blades 3/16" (5 mm) deep.

Catalog #	Description
421510	Small fenestrated blade, 3/8" wide (4 mm), overall length 1-1/8" (3 cm)
421512	Large fenestrated blade, 5/8" wide (16 mm), overall length 1-5/8" (4 cm)

FARR RETRACTORS

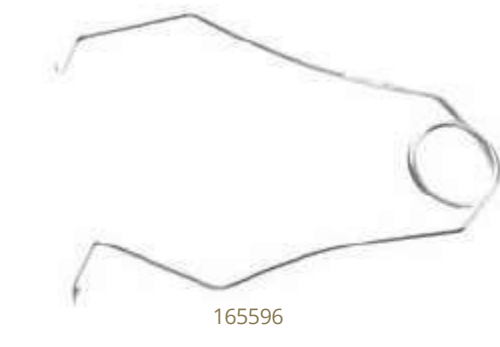

Catalog #	Description
165595	No. 1, blade 3/4" (2 cm), 5-1/2" (14 cm)
165596	No. 2, blade 1-1/8" (3 cm), 5-1/2" (14 cm)
165597	No. 3, blade 1-1/8" (3 cm), 9" (23 cm)

GRIESHABER WIRE RETRACTORS



Useful for very small incisions in minor surgery and in laboratory uses.

Catalog #	Description
165590	#1, delicate, thin wire, 1 prong, 3-1/4" (8.5 cm)
165591	#2, delicate, thin wire, 3-tooth blade, 3-1/4" (8.5 cm)
165592	#3, medium weight wire, single short prong, 4-3/4" (12 cm)
351685	Deep arteriotomy spring retractor, 3-1/4" (8.5 cm)

RETRACTORS, SELF-RETAINING

Wire and Alm-Type Retractors

HEISS RETRACTORS



Catalog #	Description
165085	4 x 4 sharp prongs, 1/8" (3 mm) deep, 4-1/8" (10.5 cm)
165086	4 x 4 blunt prongs, 1/8" (3 mm) deep, 4-1/8" (10.5 cm)

SKIN SELF-RETAINING RETRACTORS

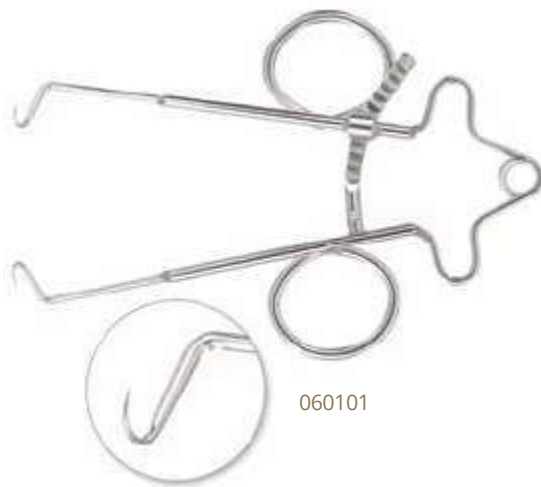

Catalog #	Description
060100	Sharp prongs, lightly angled 55 degrees, 2-1/2" (6.5 cm) spread, 3-3/4" (9.5 cm)
060101	Sharp prongs, strongly angled 80 degrees, 2-1/2" (6.5 cm) spread, 3-1/2" (9 cm)
060105	Sharp prongs, strongly angled 80 degrees, 3-1/2" (9 cm) spread, 4-3/4" (12 cm)

ALM RETRACTORS



For delicate minor surgery.

Catalog #	Description
165510	Small, 4 mm, semi-sharp teeth, 2-3/4" (7 cm)
488210	4 x 4 blunt prongs, 3" (7.5 cm)

488210

RETRACTORS, SELF-RETAINING

Wire and Alm-Type Retractors

JANSEN RETRACTORS



165550

Catalog #	Description
165550	3 x 3 blunt prongs, 5/16" (8 mm) deep, 3" (7.5 cm) spread, 4-3/8" (11 cm)
165552	3 x 3 sharp prongs, 5/16" (8 mm) deep, 2" (5 cm) spread, 4-3/8" (11 cm)

Weitlaner, Gelpi and Henly-Type Retractors

WEITLANER RETRACTORS



165352



165362

Pattern, satin finish.

Catalog #	Description
165348	2 x 3 sharp prongs, 4-1/2" (11.5 cm)
165350	3 x 4 sharp prongs, 5-1/2" (14 cm)
165352	3 x 4 sharp prongs, 6-1/2" (16.5 cm)
165354	3 x 4 sharp prongs, 7-5/8" (19.5 cm)
165356	3 x 4 sharp prongs, 9-1/2" (24 cm)
165358	2 x 3 blunt prongs, 4-1/2" (11.5 cm)
165360	3 x 4 blunt prongs, 5-1/2" (14 cm)
165362	3 x 4 blunt prongs, 6-1/2" (16.5 cm)
165364	3 x 4 blunt prongs, 7-5/8" (19.5 cm)
165366	3 x 4 blunt prongs, 9-1/2" (24 cm)

RETRACTORS, SELF-RETAINING

Weitlaner, Gelpi and Henly-Type Retractors

WEITLANER RETRACTORS



Weck® Pattern, bright finish.

Catalog #	Description
488305	2 x 3 sharp prongs, 4-1/2" (11.5 cm)
488306	2 x 3 blunt prongs, 4-1/2" (11.5 cm)

WEITLANER RETRACTORS



Pattern, satin finish.

Catalog #	Description
GS52492	2 x 3 sharp prongs 12 x 16 mm, 4" (10 cm)
GS52494	2 x 3 blunt prongs 13 mm, 4" (10 cm)
GS52498	3 x 4 sharp prongs, 5-1/4" (13.5 cm)

WULLSTEIN-WEITLANER RETRACTORS



Catalog #	Description
029550	Small, 3 x 3 sharp prongs, 11 mm deep x 12 mm wide, 4-3/8" (11 cm)
029555	Large, 3 x 3 sharp prongs, 11 mm deep x 12 mm wide, 5" (12.5 cm)

RETRACTORS, SELF-RETAINING

Weitlaner, Gelpi and Henly-Type Retractors

SCALP CONTOUR RETRACTORS



Useful in hand procedures because handle is not obstructive.

Catalog #	Description
GS52546	3 x 4 blunt prongs, 5-1/2" (14 cm)
GS52548	3 x 4 sharp prongs, 5-1/2" (14 cm)

ADSON RETRACTORS



Straight shanks.

Catalog #	Description
488360	4 x 4 sharp prongs, 7-1/2" (19 cm)
488361	4 x 4 blunt prongs, 7-1/2" (19 cm)

ADSON RETRACTORS



Contoured shanks.

Catalog #	Description
382722	4 x 4, sharp, 17 x 7 mm prongs, 7-1/4" (18.5 cm)

RETRACTORS, SELF-RETAINING

Weitlaner, Gelpi and Henly-Type Retractors

ANDERSON ADSON RETRACTOR



Angled shanks.

Catalog #	Description
382710	4 x 4 blunt, 6-3/4" (17 cm)

ADSON RETRACTOR



Hinged arm design.

Catalog #	Description
GS52474	4 x 5 blunt prongs, 13" (33 cm)

BECGSAN-WEITLANER RETRACTORS



This modification involves the addition of the BecGSan Hinge to Weitlaner Retractors. Pattern, satin finish.

Catalog #	Description
165370	3 x 4 sharp prongs, 5-1/2" (14 cm)
165372	3 x 4 sharp prongs, 6-1/2" (16.5 cm)
165374	3 x 4 sharp prongs, 8-1/4" (21 cm)
165380	3 x 4 blunt prongs, 5-1/2" (14 cm)
165382	3 x 4 blunt prongs, 6-1/2" (16.5 cm)
165384	3 x 4 blunt prongs, 8-1/4" (21 cm)

RETRACTORS, SELF-RETAINING

Weitlaner, Gelpi and Henly-Type Retractors

BECGSAN RETRACTOR



Weck® Pattern, bright finish.

Catalog #	Description
488370	4 x 4 sharp prongs, 12-1/2" (32 cm)

BECGSAN RETRACTORS



Catalog #	Description
GS52470	4 x 4 sharp prongs, 27 mm, side blade 5/8" (1.5 cm) deep, 12-1/4" (31 cm)
GS52472	4 x 4 blunt prongs, 27 mm, side blade 5/8" (1.5 cm) deep, 12-1/4" (31 cm)

BECGSAN-ADSON LAMINECTOMY RETRACTORS



With hinged blades.

Catalog #	Description
GS52484	4 x 4 blunt prongs, 28 x 29 mm, 12-1/4" (31 cm)
GS52486	4 x 4 sharp prongs, 28 x 47 mm, 12-1/4" (31 cm)
GS52488	4 x 4 blunt prongs, 25 x 44 mm, 12-1/4" (31 cm)
GS52490	4 x 4 sharp prongs, 28 x 29 mm, 12-1/4" (31 cm)

RETRACTORS, SELF-RETAINING

Weitlaner, Gelpi and Henly-Type Retractors

BECGSAN-ADSON RETRACTORS



165402

Modification of BecGSan having Adson blades.
4 x 4 blunt prongs. Pattern, satin finish.

Catalog #	Description
165400	4 x 4 blunt prongs, 1" (2.5 cm) deep blades, 12-1/4" (31 cm)
165402	4 x 4 blunt prongs, 1-1/4" (3 cm) deep blades, 13" (33 cm)

BECGSAN-EATON RETRACTOR



GS52476

Catalog #	Description
GS52476	7 x 7 sharp prongs, 40 x 48 mm, 12-1/4" (31 cm)

BECGSAN-WEITLANER RETRACTORS



GS52542

With hinged blades. Pattern, satin finish.

Catalog #	Description
GS52542	3 x 4 sharp prongs, 22 mm, 9-1/2" (24 cm)
GS52544	3 x 4 blunt prongs, 22 mm, 9-1/2" (24 cm)

RETRACTORS, SELF-RETAINING

Weitlaner, Gelpi and Henly-Type Retractors

DEBAKEY® GELPI RETRACTOR, SHORT MODEL



Catalog #	Description
165439	Sharp prongs, 5-3/8" (13.5 cm)

GELPI RETRACTORS



Weck® Pattern, bright finish. Sharp prongs.

Catalog #	Description
488390	7-1/4" (18.5 cm)
488395	5-3/8" (13.5 cm)

GELPI STANDARD RETRACTOR



Pattern, satin finish.

Catalog #	Description
165440	Standard type (no stops), single sharp prongs, 7" (18 cm)

RETRACTORS, SELF-RETAINING

Weitlaner, Gelpi and Henly-Type Retractors

GELPI RETRACTORS



GS52768

Pattern, satin finish.

Catalog #	Description
GS52776	3-1/2" (9 cm)
GS52778	4-3/8" (11 cm)
GS52768	7-1/4" (18.5 cm)
GS52769	With ball stops, 7" (18 cm)

GELPI-SELETZ RETRACTOR



GS52765

Catalog #	Description
GS52765	Sharp points, deep blades, 6-1/4" (16 cm)

RETRACTORS, SELF-RETAINING

Weitlaner, Gelpi and Henly-Type Retractors

JOHNSON NEUROMA RETRACTOR



Designed to aid in the removal of interdigital neuroma. Tips overlap in closed position making insertion and removal of retractor easier. Provides excellent visibility of neuroma when retractor is in open position.

Catalog #	Description
GS52782	Sharp, 5" (12.5 cm)

WILTSE-GELPI RETRACTOR



Deep, angled blades, sharp points.

Catalog #	Description
GS52771	Angled shaft, 10-7/8" (27.5 cm)

ORIGINAL HENLY POPLITEAL RETRACTOR



A modification of the Weitlaner retractor with provisions for attachment of a third retractor blade for improved exposure in either the popliteal or carotid positions. Supplied with 3 center blades. The retraction surfaces of the center blades are grooved for soft tissue retraction.

Catalog #	Description
351779	4 x 3 prongs, center blades: 5/8" wide x 3/4" deep (1.5 x 2 cm), 5/8" wide x 1" deep (1.5 x 2.5 cm), 5/8" wide x 1-1/4" deep (1.5 x 3 cm), overall length 6-3/8" (16 cm)

RETRACTORS, SELF-RETAINING

Weitlaner, Gelpi and Henly-Type Retractors

HENLY POPLITEAL RETRACTOR

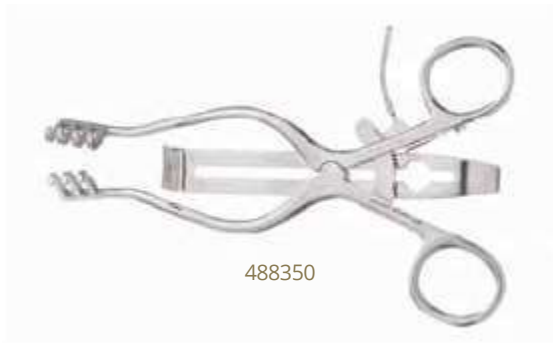

488350

Weck® Pattern, bright finish.

Catalog #	Description
488350	With 3 detachable center blades: 16 mm wide x 20 mm / 26 mm / 32 mm, 6-3/8" (16 cm)

IMPROVED HENLY RETRACTORS



351679

With interchangeable center blades and side blades.

Catalog #	Description
351679	Henly Retractor with straight arms, side blades slide onto arms
351680	Henly Retractor with arms spread outward. Both are complete with: <ul style="list-style-type: none"> • 1 frame • 3 center blades, 7/8", 1-1/8" and 1-1/4" deep x 5/8" wide, (2, 3 and 3 cm deep x 1.5 cm wide) • 3 pair of side blades with blunt prongs, 1", 2" and 3" deep x 7/8" wide, (2.5, 5 and 7.5 cm deep x 2 cm wide)



351680

RETRACTORS, SELF-RETAINING

Weitlaner, Gelpi and Henly-Type Retractors

IMPROVED HENLY RETRACTOR SIDE BLADES



351676

Shallow, medium and deep interchangeable sliding side blades.

Catalog #	Description
351676	1 pair, 1" x 7/8" (2.5 x 2 cm)
351677	1 pair, 2" x 7/8" (5 x 2 cm)
351678	1 pair, 3" x 7/8" (7.5 x 2 cm)

MAINI SIDE BLADE FOR HENLY RETRACTOR



351661

Catalog #	Description
351661	2-3/4 x 2" (7 X 5 cm), slide on

MAINI RICHARDSON DOUBLE-ENDED CENTER BLADE FOR HENLY RETRACTOR



351664

Catalog #	Description
351664	Blade ends are 31 and 40 mm wide

RETRACTORS, SELF-RETAINING

Weitlaner, Gelpi and Henly-Type Retractors

MULTIPURPOSE RETRACTORS



351667



351670



351675

A versatile self-retaining Henly type retractor designed for use in the following surgical specialties: peripheral vascular surgery in the carotid, subclavian, femoral, popliteal and tibial regions. Spinal surgery in the cervical and lumbar regions. Orthopedic surgery in shoulder and hip procedures. General surgery for inguinal hernia, appendectomy and many minor procedures.

Catalog #	Description
351667	Multipurpose Retractor, complete with: 1 Frame with a 3-1/8" (7.8 cm) spread; 3 Center Blades in sizes 7/8" (2.2 cm), 1-1/8" (2.8 cm) and 1-1/4" (3.2 cm) deep x 5/8" (1.6 cm) wide; 3 pairs of Side Blades in sizes 1-1/8" (2.9 cm), 2-1/8" (5.5 cm) and 3-1/8" (8.0 cm) deep x 7/8" (2.2 cm) wide; Self-retaining, with interchangeable center and side blades. Ball-snap attachment of side blades. Swivel side blades rotate 360 degrees.
351675	1 pair side blades, 1-1/8" x 7/8" (3 x 2 cm) for 351675
351666	1 pair side blades, 2-1/8" x 7/8" (5.5 x 2 cm) for 351675
351667	1 pair side blades, 3-1/8" x 7/8" (8 x 2 cm) for 351675
351668	Center blade, 7/8" x 5/8" (2 x 1.5 cm) for 351675
351669	Center blade, 1-1/8" x 5/8" (3 x 1.5 cm) for 351675
351670	Center blade, 1-1/4" x 5/8" (3 x 1.5 cm) for 351675
351671	Center blade, 2" x 5/8" (5 x 1.5 cm) for 351675
351672	Center blade, 2-1/2" x 5/8" (6.5 x 1.5 cm) for 351675
351673	Center blade, 2-1/2" x 5/8" (6.5 x 1.5 cm) for 351675

EXTRA LONG CENTER BLADES



351784

Fits all Henly and Multipurpose Retractors.

Catalog #	Description
351784	Two extra-long center blades in sizes 1-1/2" (4 cm) and 1-3/4" (4.5 cm) deep x 5/8" (1.5 cm) wide

RETRACTORS, SELF-RETAINING

Abdominal/Balfour-Type Retractors

BALFOUR RETRACTORS



165200

Trigger controlled, positive automatic ratchet retaining design. Free, smooth easy movement of all parts. Large selection of blade designs and sizes. Stainless steel construction.

Catalog #	Description
165200	Wire lateral blades 2" deep (5 cm), center blade 3-5/8" wide x 1-3/4" deep (9 x 4.5 cm), 7" (18 cm) spread
165203	Wire lateral blades 4-3/8" deep (11 cm), center blade 4-3/16" deep x 2-1/2" wide (10.5 x 6.5 cm), 7" (18 cm) spread
165240	Pediatric. Miniature model, arms 3-1/2" long (9 cm), lateral blades 3/4" (2 cm) deep, 4" (10 cm) spread

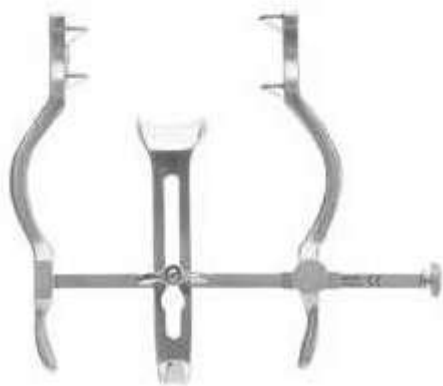

165240

RETRACTORS, SELF-RETAINING

Abdominal/Balfour-Type Retractors

BALFOUR RETRACTORS PERMANENT SIDE BLADE MODEL



Catalog #	Description
165100	Side blades 2-1/2" (6.5 cm) deep. Center blade 2-3/4" (7 cm) wide x 1-3/4" (4.5 cm) deep, standard size 8" (20.5 cm) opening
165105	Side blades 3-1/2" (9 cm) deep. Center blade 3-1/2" (9 cm) wide x 1-3/4" (4.5 cm) deep, standard size 8" (20.5 cm) opening

IMPROVED BALFOUR RETRACTORS INTERCHANGEABLE SIDE BLADE MODEL



Lateral blades may be easily snapped on and off. Set includes 2 pairs of detachable wire lateral blades 2-1/2" (6.5 cm) and 3-1/2" (9 cm) deep.

Catalog #	Description
165130	Center blade 2-1/2" (6.5 cm) wide, standard size, 8" (20.5 cm) opening
165133	Center blade 3-1/2" (8.8 cm) wide, extra wide 10-1/2" (26.5 cm) opening
165135	Extra solid lateral blades 2-1/2" (6.5 cm) deep, per pair
165137	Extra wire lateral blades, 2-1/2" (6.5 cm) deep, per pair
165138	Extra wire lateral blades, 3-1/2" (9 cm) deep, per pair



165133

RETRACTORS, SELF-RETAINING

Abdominal/Balfour-Type Retractors

TRANSPLANT RECOVERY BALFOUR RETRACTORS



Transplant retractors for the recovery of the abdominal organs. Spiked lateral blades for maximum hold.

Catalog #
165107

Description
Adult, 2 x 2 sharp prongs, blades 2-3/4" (7 cm),
overall length of arms 7-7/8" (20 cm), 17" (43 cm)
spread

RETRACTORS, SELF-RETAINING

Abdominal/Balfour-Type Retractors

BALFOURCENTERBLADES



165141

These blades are made for use with the Balfour Retractors 165100 through 165133.

Catalog#	Description
165141	Standard, 3-1/2" wide x 1-1/4" deep (8.8cm x 3.2cm)
165142	Standard, 2-3/4" wide x 1-3/4" deep (7 cm x 4.4 cm)
165143	Supra-Pubic, 3-1/2" wide x 2-5/8" deep (8.8cm x 6.8cm)
165145	Narrow, 1-5/8" wide x 3-1/2" deep (4.2 cm x 8.8 cm)
165146	Wide, 2-1/2" wide x 2-5/8" deep (6.3 cm x 6.8 cm)
165147	Wide, 2-1/2" wide x 3-1/2" deep (6.3 cm x 8.8 cm)
165149	Horgan malleable 2" wide x 7-3/4" long (5 x 19.5 cm)
165150	Horgan malleable 2-1/2" wide x 8" long (6.5 x 20.5 cm)



165142



165146



165149

YU HOLTGREVE MALLEABLE BLADE



165160

Catalog#	Description
165160	2-1/2" wide x 5-7/8" deep x 9-3/8" long (6.5 x 15 x 24 cm)

RETRACTORS, SELF-RETAINING

Abdominal/Balfour-Type Retractors

BALFOUR FOURTH BLADE ATTACHMENTS



165170

Locks securely to arm of Balfour retractors, holding fourth blade. (Blade not included.)

Catalog #	Description
165170	For right arm
165171	For left arm

O'SULLIVAN-O'CONNOR ABDOMINAL RETRACTORS



485450

Catalog #	Description
165300	Adjustable shape ring Spread 7-1/2" (20 cm) Two lateral blades, 1" wide x 3" deep (2.5 x 7.5 cm) Set complete with three detachable blades: 2 small, 1-3/4" wide x 3" deep (4.5 x 7.5 cm), and 1 large, 2-3/4" wide x 4-1/8" deep (7.0 x 10.5 cm) Positive action ratchet regulates diameter Blades on frame are 73 x 27 mm
485450	Three detachable blades: 2 small, 1-3/4" wide x 3-1/8" deep (4.5 x 8 cm), and 1 large, 2-7/8" wide x 4" deep (7 x 10 cm) Spread 12-1/2" (32 cm)

WEXLER BANTAM RETRACTOR



486100

For pediatric and minor surgery use. Set comes complete with frame, 1 center blade and 2 side blades.

Catalog #	Description
486100	Center blade is 1-1/4" deep x 3/4" wide (3 x 2 cm), side blade is 1-1/8" deep x 7/8" wide (3 x 2.5 cm), 3-7/8" (10 cm) spread

RETRACTORS, SELF-RETAINING

Abdominal/Balfour-Type Retractors

WEXLER STANDARD OCTAGON FRAME



485205

Lateral catches for two blades.

Catalog #	Description
485205	11-5/16" x 9-3/16" (28.5 x 23.5 cm)

UNIVERSAL JOINT FOR WEXLER RETRACTORS



485210

Catalog #	Description
485210	Allows rotation on ball with locking arm for Wexler Retractors

WEXLER DEEVER BLADE



485220

For Wexler Retractors.

Catalog #	Description
485220	2" wide x 4-5/16" deep (5 x 11 cm), 9" (23 cm)

RETRACTORS, SELF-RETAINING

Abdominal/Balfour-Type Retractors

WEXLER DEEP SPREADER



485262

For Wexler Retractors.

Catalog #
485262Description
4" x 1-7/8" blades (10 x 5 cm), 5-1/4" (13.5 cm),
pair of 2

WEXLER EXPANDABLE BLADE



485225

Catalog #
485225Description
2-3/4" (7 cm) wide blade, expands to 5" (12.5 cm)

RETRACTORS, SELF-RETAINING

Thyroid Retractors

HAMBURGER-BRENNAN-MAHORNER RETRACTOR



485270

Set comes complete with frame and 2 side blades.

Catalog #
485270

Description
7 pointed prongs, 18 x 32 mm, detachable side blades are 5-3/4" (14.5 cm), 33 x 29 mm blade, 4" (10 cm) spread, overall length 9-1/16" (23 cm)

MAHORNER THYROID RETRACTOR

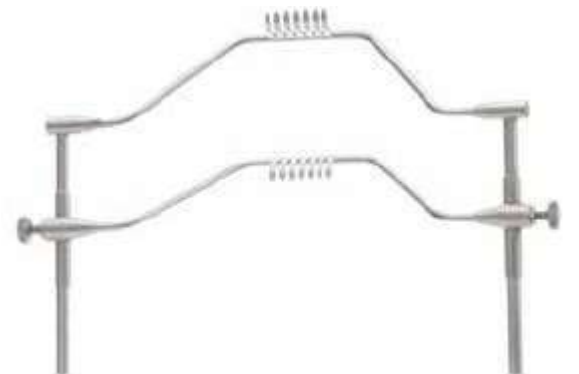

485265

Catalog #
485265

Description
7 pointed prongs, 15 x 32 mm, 4-3/8" (11 cm) spread, overall 9" (23 cm)

ORTHOPEDIC RETRACTORS

ORTHOPEDIC RETRACTORS

Hand-Held Orthopedic Retractors

ORTHOPEDIC INSTRUMENTS

RAZIER HOOKS



5" (12.5 cm).

CATALOG #	Description
GS48158	1 sharp prong, 2.5 mm diameter
GS48161	1 blunt prong, 2.5 mm diameter

GILLIES HOOKS



7" (18 cm).

CATALOG #	Description
GS58077	Small
GS58083	Large

ADSON DISSECTOR HOOKS

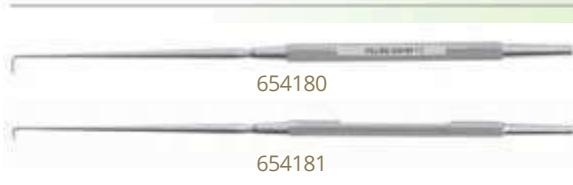

8" (20.5 cm).

CATALOG #	Description
654180	Blunt
654181	Sharp

ORTHOPEDIC RETRACTORS

Hand-Held Orthopedic Retractors

FRAZIER DURA HOOKS



654191

CATALOG #	Description
654190	Blunt, 4-3/4" (12 cm)
654191	Sharp, 4-7/8" (12.5 cm)

HOEN HOOKS



594400

9-1/4" (23.5 cm).

CATALOG #	Description
594400	Short prong
594402	Long prong

SNOOK HOOK



GS71431

Veterinary.

CATALOG #	Description
GS71431	8" (20.5 cm)

SMITHWICK DISSECTOR AND HOOK



622700

CATALOG #	Description
622700	12-1/4" (31 cm)

ORTHOPEDIC RETRACTORS

Hand-Held Orthopedic Retractors

ORTHOPEDIC INSTRUMENTS

WOLFSHER NERVE RETRACTORS



Primarily used to retract the nerve root. Blunt hook.
9-1/2" (24 cm).

CATALOG #	Description
GS48234	7 mm blade
GS48237	9 mm blade

NERVE ROOT RETRACTOR



Retractor blade lies on same plane as surgeon's finger.
Gives surgeon unobstructed view.

CATALOG #	Description
GS55424	6 mm blade, 8-1/4" (21 cm)

BAYONET NERVE RETRACTOR

CATALOG #	Description
GS46932	7 mm wide x 1 mm deep blade

ORTHOPEDIC RETRACTORS

Hand-Held Orthopedic Retractors

SCOVILLE NERVE ROOT RETRACTORS



Angled.

CATALOG #	Description
GS55426	8 mm blade, 8" (20.5 cm)
GS55428	13 mm blade, 7-5/8" (19.5 cm)

PERPENDICULAR NERVE RETRACTOR

CATALOG #	Description
GS46930	7 mm wide x 1 mm deep blade angled 90 degrees

RAGNELL-LINDE RETRACTOR



Fine cross serrations help prevent slippage.
Double-ended with serrations, 5-1/4" (13.5 cm).

CATALOG #	Description
GS69982	4 x 8 mm and 6 x 15 mm blades

ORTHOPEDIC RETRACTORS

Hand-Held Orthopedic Retractors

ORTHOPEDIC INSTRUMENTS

BLADE RETRACTORS



GS55421

CATALOG #	Description
GS55420	18 mm wide blade, 7" (18 cm)
GS55421	20 mm wide blade, 7" (18 cm)
GS55422	23 mm wide blade, 7" (18 cm)

LANGENBECK RETRACTORS



GS51104

CATALOG #	Description
GS51100	#1, 3/8" x 1-1/4" (10 x 32 mm), 8-7/8" (22.5 cm)
GS51104	#2, 3/8" x 1-3/4" (10x45mm), 8" (20.5cm)
GS51108	#3, 1/2" x 1-3/4" (15 x 45 mm), 8-1/2" (21.5 cm)
GS51112	#4, 5/8" x 1-1/2" (16x38mm), 8" (20.5cm)

DEEPRAKER RETRACTORS



GS52294

10-1/2"(26.5cm).

CATALOG #	Description
GS52292	4 blunt prongs, 2-1/4" wide x 1-1/2" deep (5.5 x 4 cm)
GS52294	4 blunt prongs, 2-1/4" wide x 2" deep (5.5 x 5 cm)
GS52296	4 blunt prongs, 2-1/4" wide x 2-1/2" deep (5.5 x 6.5 cm)
GS52298	4 blunt prongs, 2-1/4" wide x 3" deep (5.5 x 7.5 cm)

ORTHOPEDIC RETRACTORS

Hand-Held Orthopedic Retractors

ISRAEL RAKE RETRACTORS



9-1/2" (24 cm).

CATALOG #	Description
GS51078	3 blunt prongs, 30 mm wide x 37 mm deep
GS51080	4 blunt prongs, 40 mm wide x 40 mm deep

OLLIER RAKE RETRACTOR



CATALOG #	Description
GS52282	4 blunt prongs, 55 mm wide x 40 mm deep blade, 9" (23 cm)

MEYERDING LAMINECTOMY RETRACTORS



Sharp teeth.

CATALOG #	Description
GS51158	Small, 17 mm wide blade, 9-1/2" (24 cm)
GS51162	Medium, 25 mm wide blade, 9-1/2" (24 cm)
GS51164	Large, 50 mm wide blade, 10" (25.5 cm)

ORTHOPEDIC RETRACTORS

Hand-Held Orthopedic Retractors

ORTHOPEDIC INSTRUMENTS

TAYLOR SPINAL RETRACTORS



GS52458

CATALOG #	Description
GS52458	1-1/4" wide x 3" long blade (3 x 7.5 cm), 7-3/4" (19.5 cm)
GS52460	1-1/4" wide x 4" long blade (3 x 10 cm), 7-3/4" (19.5 cm)

TAYLOR RETRACTORS



GS46936

CATALOG #	Description
GS46934	Distal tip 3/4" wide and 3" long (20 x 76 mm), overall length 8-1/8" (20.5 cm)
GS46936	Distal tip 3/4" wide and 4" long (20 x 102 mm), overall length 8-1/8" (20.5 cm)

HIBBS RETRACTORS



GS51060

Used for deep soft tissue retraction. Sharp teeth,
9-1/2" (24 cm).

CATALOG #	Description
GS51059	25 mm wide x 50 mm deep blade
GS51060	26 mm wide x 75 mm deep blade
GS51061	25 mm wide x 100 mm deep blade

ORTHOPEDIC RETRACTORS

Hand-Held Orthopedic Retractors

AUFRANC COBRA RETRACTORS



With hollow handle, 1-1/4" wide blade, 10-1/2" (26.5 cm).

CATALOG #	Description
GS48208	Serrated, pointed tip, 10 mm
GS48212	Smooth, blunt tip, 10 mm
GS48210	Serrated, blunt tip, 10 mm
GS48214	Smooth, pointed tip, 10 mm

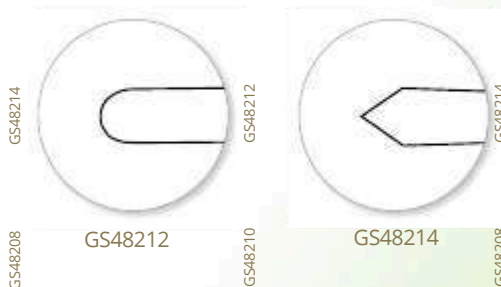

SR 48208 CU,Old

SR 48208 CU,Old

BENNETT BONE ELEVATOR AND RETRACTORS



Hollow handle, 10" (25.5 cm).

CATALOG #	Description
GS46880	Small, 1-3/4" (4.5 cm) wide blade
GS46884	Large, 2-1/2" wide blade

ORTHOPEDIC RETRACTORS

Hand-Held Orthopedic Retractors

ORTHOPEDIC INSTRUMENTS

DELVIC RETRACTOR



d10, UC10284RS

CATALOG #
GS48201

Description
1" (24 mm) wide blade, 1/2" (12 mm) wide distal tip,
10-5/8" (27 cm)

GS48201



MURPHY BONE SKID



GS46892

CATALOG #
GS46892

Description
11-3/4" (30 cm)

ORTHOPEDIC RETRACTORS

Shoulder and Knee Retractors

FUKUDA STYLE SHOULDER RETRACTORS



7" (18 cm).

CATALOG #	Description
GS46906	1-1/2" wide x 3-1/4" long blade (4 x 8 cm)
GS46907	1-1/4" wide x 3-1/4" long blade (3 x 8 cm)

CAPSULE RETRACTOR



CATALOG #	Description
GS46908	3 sharp prongs, 22 mm wide blade, 10" (25.5 cm)

BRISTOW/BANKART SOFT TISSUE RETRACTOR



CATALOG #	Description
GS46872	3 blunt prongs, 21 mm wide blade, 7-7/8" (20 cm)

ORTHOPEDIC RETRACTORS

Shoulder and Knee Retractors

ORTHOPEDIC INSTRUMENTS

CRISTOW/BANKART HUMERAL RETRACTOR

CATALOG #
GS46870Description
2 blunt prongs, 25 mm wide x 102 mm deep, 7-1/2"
(19 cm)

HUMERAL HEAD RETRACTOR

CATALOG #
GS46860Description
18 mm wide blade, 8-3/4" (22 cm)

ORTHOPEDIC RETRACTORS

Shoulder and Knee Retractors

BLOUNT DOUBLE PRONG RETRACTOR



CATALOG #	Description
GS48204	1-3/4" (44 mm) wide blade, 10-1/2" (26.5 cm)

BLOUNT KNEE RETRACTOR



CATALOG #	Description
GS48206	6 mm wide distal tip, 6-7/8" (17.5 cm)

BLOUNT SINGLE PRONG RETRACTOR



CATALOG #	Description
GS48202	1-1/2" (37 mm) width blade, 10-1/2" (26.5 cm)

ORTHOPEDIC RETRACTORS

Shoulder and Knee Retractors

ORTHOPEDIC INSTRUMENTS

MILLIE KNEE RETRACTORS



5-1/2" (14 cm).

CATALOG #	Description
GS48192	Reverse curve, 13 mm wide x 55 mm long blade
GS48198	19 mm wide x 30 mm long blade
GS48194	19 mm wide x 45 mm long blade
GS48196	19 mm wide x 60 mm long blade
GS48200	Full curve, 13 mm wide x 18 mm long blade



ORTHOPEDIC RETRACTORS

Hohmann Retractors

HAYES HAND RETRACTORS



Used to elevate carpals and phalanges during hand procedures.

CATALOG #	Description
GS46823	3 mm wide distal tip, 6-1/4" (16 cm)
GS46829	6 mm wide distal tip, 6" (15 cm)

MINI HOHMANN RETRACTORS

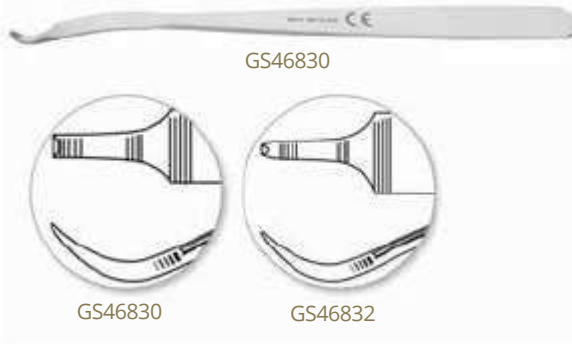

6-1/2" (16.5 cm).

CATALOG #	Description
GS46830	6 mm wide blade
GS46832	8 mm wide blade

ORTHOPEDIC RETRACTORS

Hohmann Retractors

ORTHOPEDIC INSTRUMENTS

HOHMANN RETRACTORS

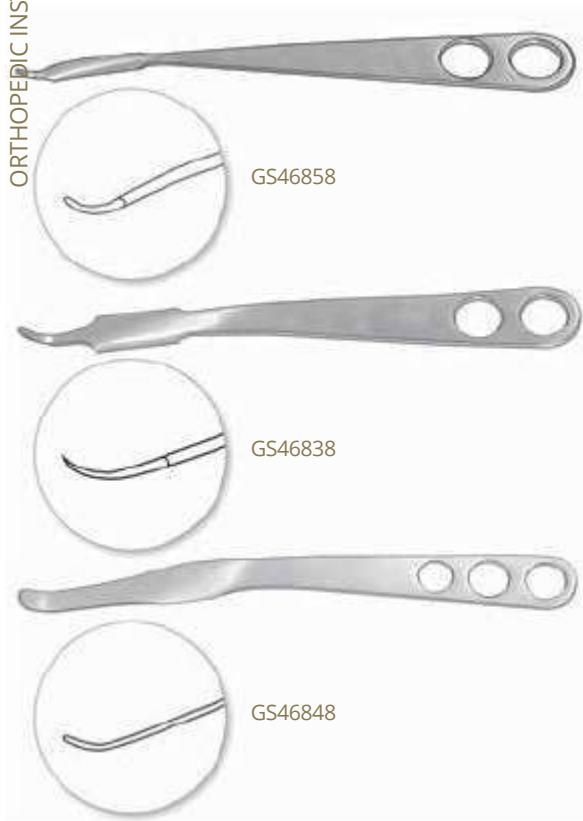

CATALOG #	Description
GS46858	8 mm wide blade, 8-1/2" (21.5 cm)
GS46836	10 mm wide blade, 9" (23 cm)
GS46838	18 mm wide blade, 9" (23 cm)
GS46848	22 mm wide blade, three holes, 11" (28 cm)

ORTHOPEDIC RETRACTORS

Hohmann Retractors

HOHMANN RETRACTORS



CATALOG #	Description
GS46842	43 mm wide blade, 9-1/2" (24 cm)
GS46841	43 mm wide blade, long 64 mm shank, 9" (23 cm)
GS46850	70 mm wide blade, 9-1/2" (24 cm)

HOHMANN RETRACTORS



For small fragments.

CATALOG #	Description
GS46826	Finger ring handle, broad tip, 16 mm wide blade, 4-3/4" (12 cm)

ORTHOPEDIC RETRACTORS

Hohmann Retractors

ORTHOPEDIC INSTRUMENTS

HOHMANN RETRACTORS



GS46827

CATALOG #	Description
GS46827	Broad tip, 15 mm wide blade, 6" (15 cm)

HOHMANN RETRACTORS

Useful in exposing acetabulum.



d10,U004864RS

GS46849

CATALOG #	Description
GS46849	35 mm wide blade with wide tip, long 52 mm shank, 11-1/4" (28.5 cm)
GS46852	22 mm wide blade curved 120 degrees, 16" (40.5 cm)
GS46854	40 mm wide blade curved 90 degrees, 13" (33 cm)

d10,ed15258-64RS



GS46852



GS46854



RS
-64
458
ed15
'
d10

VICKERS FINGER RETRACTOR

The new Vickers Retractors are designed to provide excellent visibility during hand and wrist procedures. Each of the retractors is self-retaining and automatically expands the wound site. Ideal for retracting wounds on either the front, back or sides of fingers or thumb.



VICKERS FINGER RETRACTOR
GS52425
2" x 3/4" x 1-1/4"
(51 mm x 19 mm x 32 mm)
2 x 2 blunt hooks
Maximum opening: 19 mm

ORTHOPEDIC RETRACTORS

Self-Retaining Orthopedic Retractors

ORTHOPEDIC INSTRUMENTS

VICKERS LOW PROFILE SMALL WOUND RETRACTOR



GS52426

CATALOG #
GS52426

Useful for small wound retraction.

Description
10 mm deep x 12 mm high, curved, smooth blades,
maximum opening 30 mm, center blade
10 mm x 16 mm, 2-1/2" x 3" (6.5 x 7.5 cm)

VICKERS LOW PROFILE HAND RETRACTOR



GS52427

With three blunt prongs to secure placement.

CATALOG # Description
GS52427 3 x 3 prongs, 3-1/4" (8.5 cm)

VICKERS UNIVERSAL RETRACTOR



GS52428

With two blunt prongs to secure placement.

CATALOG # Description
GS52428 2 x 2 blunt prongs, 8 mm deep x 17 mm high,
maximum opening 30 mm, center blade
10 mm x 16 mm, 2-1/2" x 3" (64 x 75 mm)

ORTHOPEDIC RETRACTORS

Self-Retaining Orthopedic Retractors

COX METATARSAL SPREADER



- Specially designed thin serrated blades fit anatomically correct against the metatarsals.
- Precise design assures slip-proof hold on metatarsals.
- Afford excellent visibility for the surgeon.
- Designed by Dr. Kenneth Cox.
- A Exclusive Product.

CATALOG #	Description
GS69990	11 mm wide blades, 4-1/2" (11.5 cm)

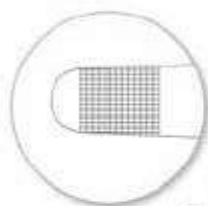

GS69990

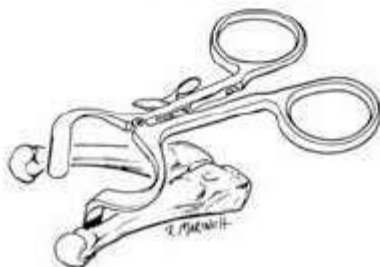
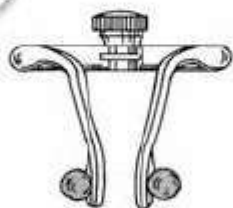

MALTZ-SEEBURGER RETRACTORS



GS58240

CATALOG #	Description
GS58240	4-1/2" (11.5 cm)
GS58242	5-1/2" (14 cm)

ORTHOPEDIC RETRACTORS

Self-Retaining Orthopedic Retractors

ORTHOPEDIC INSTRUMENTS

NITMAN ENDAURAL RETRACTOR

CATALOG #
GS55497Description
3 x 3 sharp prongs

GS55497

TISSUE RETRACTOR

CATALOG #
GS55438Description
1 x 1 blunt prongs, 13 mm deep, 5-1/4" (13.5 cm)

GS55438

ORTHOPEDIC RETRACTORS

Self-Retaining Orthopedic Retractors

KOLBEL SOFT TISSUE RETRACTOR



GS46922

CATALOG #	Description
GS46922	Angled, 2 x 2-pronged, 7" (18 cm)

SCALP CONTOUR RETRACTORS



GS52546

Useful in hand procedures because handle is non-obstructive.

CATALOG #	Description
GS52546	3 x 4 blunt prongs, 5-1/2" (14 cm)
GS52548	3 x 4 sharp prongs, 5-1/2" (14 cm)

ORTHOPEDIC RETRACTORS

Self-Retaining Orthopedic Retractors

ORTHOPEDIC INSTRUMENTS

FERRICO-ADSON RETRACTOR



Angular prongs are heavier than those on a standard Adson.

CATALOG #
GS55498

Description
4 x 4 sharp prongs, 3/4" (2 cm) deep blade,
7-3/8" (19 cm)

ORTHOPEDIC RETRACTORS

Self-Retaining Orthopedic Retractors

MEYERDING LAMINECTOMY RETRACTORS



GS55431

Sharp blades, 6-1/2" (16.5 cm).

CATALOG #	Description
GS55430	Blades 57 mm deep x 25 mm wide
GS55431	Blades 51 mm deep x 25 mm wide
GS55432	Blades 41 mm deep x 25 mm wide

MARKHAM-MEYERDING HEMILAMINECTOMY RETRACTORS



GS55440

GS55441

CATALOG #	Description
GS55440	Left sharp blade 60 mm deep x 25 mm wide, 7" (18 cm)
GS55441	Right sharp blade 60 mm deep x 25 mm wide, 7" (18 cm)

ORTHOPEDIC RETRACTORS

Self-Retaining Orthopedic Retractors

ORTHOPEDIC INSTRUMENTS CERVICAL RETRACTOR SET



GS55481

CATALOG #	Description
GS55481	Cervical retractor body, small, 6" (15 cm)
GS55482	25 mm deep blade, blunt
GS55483	30 mm deep blade, blunt
GS55484	35 mm deep blade, blunt
GS55485	40 mm deep blade, blunt
GS55486	45 mm deep blade, blunt
GS55487	50 mm deep blade, blunt
GS55488	55 mm deep blade, blunt

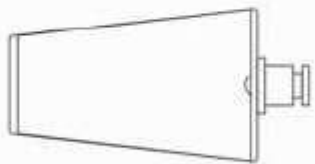

GS55485



GELPI-SELETZ RETRACTOR



GS52765

CATALOG #	Description
GS52765	Sharp points, deep blades, 6-1/4" (16 cm)

ORTHOPEDIC RETRACTORS

Self-Retaining Orthopedic Retractors

WILTSE-GELPI RETRACTOR

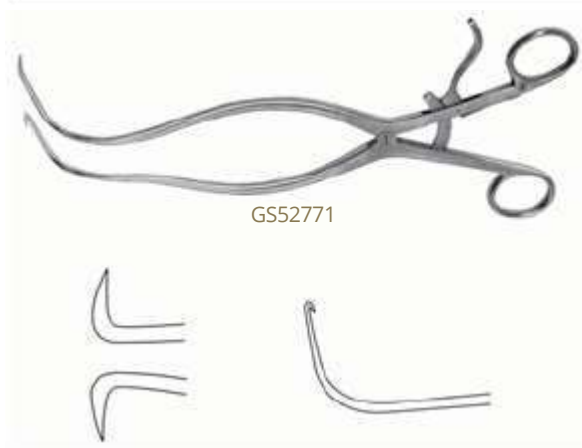

CATALOG #
GS52771

Description
Deep blades, sharp points, 10-7/8" (27.5 cm)

GS52771

ADSON RETRACTOR



Hinged arm design.

CATALOG #
GS52474

Description
4 x 5 blunt prongs, 13" (33 cm)

GS52474

BECGSAN RETRACTOR



CATALOG #
GS52470

Description
4 x 4 sharp prongs, 27 mm, side blade 5/8" (1.5 cm) deep, 12-1/4" (31 cm)

GS52472

4 x 4 blunt prongs, 27 mm, side blade 5/8" (1.5 cm) deep, 12-1/4" (31 cm)

GS52470

ORTHOPEDIC RETRACTORS

Self-Retaining Orthopedic Retractors

BECGSAN-EATON RETRACTOR



CATALOG #	Description
GS52476	7 x 7 sharp prongs, 40 x 48 mm, 12-1/4" (31 cm)

BECGSAN-ADSON LAMINECTOMY RETRACTORS



4 x 4 prongs, hinged blades 25 mm high, 12-1/4" (31 cm).

CATALOG #	Description
GS52484	Blunt, 25 mm deep
GS52488	Blunt, 44 mm deep, max. opening 6"
GS52486	Sharp, 44 mm deep
GS52490	Sharp, 25 mm deep, max. opening 5-11/16"

BECGSAN-WEITLANER RETRACTORS



With hinged blades. Pattern, satin finish, 9-1/2" (24 cm).

CATALOG #	Description
GS52542	3 x 4 sharp prongs, 22 mm
GS52544	3 x 4 blunt prongs, 22 mm

HORIZONTAL RETRACTOR



Primarily used to retract detached trochanter from the stump of the femoral neck. Hinged arms allow handles to be angled away from surgical site to minimize interference.

CATALOG #	Description
GS52602	Hinged blades, 4 x 2 sharp prongs, 12-1/4" (31 cm)

ORTHOPEDIC RETRACTORS

Self-Retaining Orthopedic Retractors

VERTEBRA SPREADER (CLOWARD)



<p>CATALOG # GS55490</p>	<p>Description #1 with ratchet, 3/4" (19 mm) spread, 5" (12.5 cm)</p>
------------------------------	---------------------------------------------------------------------------

LUMBAR LAMINA SPREADERS



<p>CATALOG # GS55495 GS55496</p>	<p>Description #1, arm length, 3-1/2" (9 cm), 5-1/4" (13.5 cm) #2, arm length, 4-1/4" (11 cm), 5-1/4" (13.5 cm)</p>
------------------------------------------	-----------------------------------------------------------------------------------------------------------------------------

VERTEBRAL BODY DISTRACTORS



<p>CATALOG # GS55410 GS55412</p>	<p>Description Small Large, 11 mm wide x 3.8 mm deep jaws, 11-1/4" (28.5 cm)</p>
------------------------------------------	----------------------------------------------------------------------------------------------

ORTHOPEDIC RETRACTORS

Self-Retaining Orthopedic Retractors

ORTHOPEDIC INSTRUMENTS

WEDGE RETRACTOR



Available with or without teeth.

CATALOG #	Description
GS48217	With teeth, 6-1/2" (16.5 cm)
GS48218	Without teeth, 6-1/2" (16.5 cm)
GS48230	With teeth, 10-3/8" (26.5 cm)

SAXENA BONE GRAFTING RETRACTOR



- Ratchet is calibrated in millimeters to accurately assess how wide the lateral portion of the bone graft needs to be.
- Helpful in many types of procedures to accurately assess the amount of bone graft needed, such as for fusions and nonunions.
- Available exclusively from .

CATALOG #	Description
GS48220	35 mm graduated ratchet, 6-1/2" (16.5 cm)

ORTHOPEDIC RETRACTORS

Self-Retaining Orthopedic Retractors

LAMINA SPREADERS



GS48226

CATALOG #	Description
GS48228	Concave blades, 10-1/2" (26.5 cm)
GS48226	Flat blades, 10-3/4" (27.5 cm)



GS48228

ORTHOPEDIC RETRACTORS

Self-Retaining Orthopedic Retractors

INITIAL INCISION (CHARNLEY) RETRACTOR

ORTHOPEDIC INSTRUMENTS



GS52704



GS52707L



GS52707S

Used primarily for hip procedures.

CATALOG #	Description
GS52704	4 sharp prongs, stainless steel, maximum retraction width 9-3/4" (24.5 cm), prong depth 1-1/4" (32 mm), blade width 1" (25 mm), weight 3 lbs. Other blades are available
GS52704F	Frame only
GS52704S	Short blade, 1-1/4" deep x 1" wide (34 x 25 mm)
GS52705S	Short blade, 2" deep x 1" wide (51 x 25 mm)
GS52706S	Short blade, 2-1/4" deep x 1" wide (57 x 25 mm)
GS52707S	Short blade, 2-1/2" deep x 1" wide (64 x 25 mm)
GS52708S	Short blade, 3" deep x 1" wide (77 x 25 mm)
GS52709S	Short blade, 4" deep x 1" wide (102 x 25 mm)
GS52711S	Short blade, 5" deep x 1" wide (127 x 25 mm)
GS52704L	Long blade, 1-1/4" deep x 1" wide (34 x 25 mm)
GS52705L	Long blade, 2" deep x 1" wide (51 x 25 mm)
GS52706L	Long blade, 2-1/4" deep x 1" wide (57 x 25 mm)
GS52707L	Long blade, 2-1/2" deep x 1" wide (64 x 25 mm)
GS52708L	Long blade, 3" deep x 1" wide (77 x 25 mm)
GS52709L	Long blade, 4" deep x 1" wide (102 x 25 mm)
GS52711L	Long blade, 5" deep x 1" wide (127 x 25 mm)

SCOVILLE HEMILAMINECTOMY RETRACTOR BODY



GS55445

CATALOG #	Description
GS55445	Spread 6-3/4" (17 cm), arm length 5-1/2" (14 cm)

ORTHOPEDIC RETRACTORS

Self-Retaining Orthopedic Retractors

HAVERFIELD-SCOVILLE HEMILAMINECTOMY RETRACTOR BODY



GS55446

CATALOG #	Description
GS55446	Body only, 8-3/8" (21.5 cm)

SCOVILLE-HAVERFIELD RETRACTOR BLADE



GS55455

CATALOG #	Description
GS55455	1" x 3-1/2"

MEYERDING BLADES



GS55459

CATALOG #	Description
GS55458	1" wide x 2 1/4" deep (25 x 57 mm)
GS55459	1" wide x 3" deep (25 x 76 mm)
GS55460	2" wide x 3-1/4" deep (51 x 83 mm)

ORTHOPEDIC RETRACTORS

Self-Retaining Orthopedic Retractors

ORTHOPEDIC INSTRUMENTS

COVILLE BLADES



GS55451

Solid.

CATALOG #	Description
GS55451	1" wide x 2-1/2" deep (25 mm x 64 mm)
GS55452	2" wide x 2-1/2" deep (51 mm x 64 mm)
GS55453	1-1/8" wide x 2-5/8" deep (29 mm x 67 mm)
GS55454	1" wide x 3-1/2" deep (25 mm x 89 mm)

HIBBS BLADES



GS55465

CATALOG #	Description
GS55461	1" wide x 2" deep (25 x 51 mm)
GS55463	1" wide x 2-1/2" deep (25 x 64 mm)
GS55465	1" wide x 3" deep (25 x 76 mm)
GS55468	1" wide x 4" deep (25 x 102 mm)
GS55464	1-1/2" wide x 2-1/2" deep (38 x 64 mm)
GS55466	1-1/2" wide x 3" deep (38 x 76 mm)
GS55462	2" wide x 2" deep (51 x 51 mm)
GS55467	2" wide x 3" deep (51 x 76 mm)
GS55469	2" wide x 4" deep (51 x 102 mm)

TAYLOR LAMINECTOMY BLADE



GS55473

CATALOG #	Description
GS55473	3 prongs, 1-1/2" wide x 1-3/4" deep (38 x 44 mm)

ORTHOPEDIC RETRACTORS

Self-Retaining Orthopedic Retractors

SCOVILLE BLADES



GS55456

4-prong.

CATALOG #
GS55456
GS55457

Description
1-1/2" wide x 1-5/8" deep (38 x 41 mm)
1-7/8" wide x 2-5/8" deep (48 x 67 mm)

TAYLOR LAMINECTOMY BLADES



GS55474

4-prong.

CATALOG #
GS55474
GS55476
GS55475

Description
2" wide x 1-7/8" deep (51 x 48 mm) 2-
1/4" wide x 3-1/8" deep (57 x 79 mm)
2-1/2" wide x 2-1/2" deep (64 x 64 mm)

TAYLOR SPINAL BLADES



GS55472

CATALOG #
GS55471
GS55472

Description
1-1/4" wide x 3" deep (32 x 76 mm)
1-1/4" wide x 4" deep (32 x 102 mm)

ORTHOPEDIC RETRACTORS

Self-Retaining Orthopedic Retractors

ORTHOPEDIC INSTRUMENTS

COVILLE BLADES



GS55447



GS55449

Hook style.

CATALOG #	Description
GS55447	2" deep (51 mm)
GS55448	3" deep (76 mm)
GS55449	2" deep (51 mm) with cross bar
GS55450	2-3/4" deep (70 mm) with cross bar

FRAZIER LAMINECTOMY RETRACTOR



GS52702

CATALOG #	Description
GS52702	3 x 4 blunt prongs, spread 3-1/2" (9 cm), arm length 5" (12.5 cm)

ORTHOPEDIC RETRACTORS

Self-Retaining Orthopedic Retractors

CRUTCHFIELD TONGS



GS48249

CATALOG #
GS48249

Description
With two drills, 4-7/8" (12.5 cm)

RIB INSTRUMENTS

RIB INSTRUMENTS

Rongeurs

DALE FIRST RIB RONGEUR



342142

Catalog #
342142

Description
3 x 15 mm jaw, 14-1/2" (37 cm)

URSCHEL-LEKSELL RONGEUR



342143

Strong, double action rongeur.

Catalog #
342143

Description
8.5 x 15 mm jaw, 12-1/4" (31 cm)

RUSKIN RONGEUR



341836

Catalog #
341836

Description
4 mm bite, 6-1/8" (15.5 cm)

RIB INSTRUMENTS

Rongeurs

STILLE-LUER DUCKBILL RONGEUR



Catalog #	Description
341803	Angled, 5 mm wide jaw, 9" (23 cm)

SAUERBRUCH RONGEURS



Double action. Square bite, straight jaws, 11-3/4" (30 cm).

Catalog #	Description
342102	13mm
342105P	17mm
342107	20mm

URSHEL FIRST RIB RONGEUR



A specially designed, long, extra-heavy, pituitary-type rongeur to achieve complete removal of the neck and head of the first rib.

Catalog #	Description
342141	5 x 12 mm jaw, working length 9" (23 cm)

RIB INSTRUMENTS

Approximators

BAILEY RIB APPROXIMATOR RETRACTORS



Rib approximation is brought about by engaging jaws around ribs and turning large thumb screw. Automatic ratchet holds blades in place. Dull, non-glare finish stainless steel.

Catalog #	Description
341448	Small size
341450	Regular, adult size

BAILEY-GIBBON RIB APPROXIMATOR RETRACTOR



Catalog #	Description
341460	Same as Bailey except for lengthening of arms holding the blades. This raises the body of the retractor up, away from the ribs. Dull, non-glare finish, stainless steel.

Raspatories and Periosteal Elevators

ALEXANDER PERIOSTEOTOME



Double-end, stainless steel blades. Cross-serrated handle.

Catalog #	Description
343145	Standard model, 8-1/4" (21 cm)

RIB INSTRUMENTS

Raspatories and Periosteal Elevators

CUSHING BLUNT ELEVATOR



358344

Catalog #
358344

Description
6 mm blunt blade, 7-1/4" (18.5 cm)

DOYEN RASPATORIES

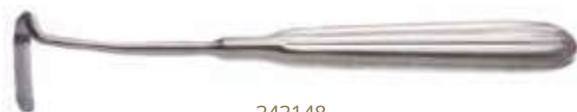

343148

Made in infant, child and adult sizes and in right and left side models. Stainless steel blades.

Catalog #
343148
343149
343152
343153

Description
Infant size, right side, 5-7/8" (15 cm)
Infant size, left side, 5-7/8" (15 cm)
Adult size, right side, 6-3/4" (17 cm)
Adult size, left side, 6-1/2" (16.5 cm)



343153

FREER DOUBLE-END ELEVATOR



355194

Pattern, satin finish.

Catalog #
355194

Description
Sharp and blunt, 7" (18 cm)

RIB INSTRUMENTS

Rib Shears/Sternum Cutters

BETHUNE RIB CUTTER



Double-curved shafts. For all ribs including first rib.

Catalog #	Description
341950	13-3/4" (35 cm)

CORYLLOS-BETHUNE RIB SHEARS



With recessed points to protect brachial plexus.

Catalog #	Description
341960	Right, 13-3/4" (35 cm)
341961	Left, 13-3/4" (35 cm)

ROOS FIRST RIB SHEAR



A right angle rib shear designed for posterior resection of the first rib through the axillary approach. By proper placement of the shear far posteriorly on the first rib, the remaining stump will be so short that it will not require revision with rongeurs. This adds greatly to the procedure by avoiding possible injury to the brachial plexus.

Catalog #	Description
341985	12-1/2" (32 cm)

RIB INSTRUMENTS

Rib Shears/Sternum Cutters

STILLE PATTERN RIB SHEARS



341980

Catalog #
341980Description
10-1/4" (26 cm)

LEBSCHKE STERNUM KNIFE



342020

For splitting the sternum down the midline. Cross-serrated section is hit with mallet to provide cutting force. Recommended for use with the 11 oz Nylon Head Mallet (051525).

Catalog #
342020Description
9-7/8" (25 cm)

RONGEURS

RONGEURS

Single Action Design

SYNOVECTOMY RONGEURS



Catalog #
GS47252
GS47253

Description
2 x 5 mm bite, extremely delicate.
Slightly curved, 6-7/8" (17.5 cm)
Strongly curved, 6-3/4" (17 cm)

RONGEUR #4



Catalog #
GS47274

Description
Curved, 4 x 9 mm bite, 5-1/2" (14 cm)

RONGEUR #4A



Catalog #
GS47275

Description
Curved, 4 x 7 mm bite, 6-1/2" (16.5 cm)

RONGEURS

Single Action Design

ORTHOPEDIC INSTRUMENTS

MICRO FRIEDMAN RONGEURS



1.5 x 5 mm bite. For soft tissue and cancellous bone only. Extremely delicate.

Catalog #	Description
GS47240	Straight, 5-3/4" (14.5 cm) 30
GS47242	degree angled, 5-1/2" (14 cm)
GS47244	90 degree angled, 5-1/2" (14 cm)

RONGEURS

Single Action Design

MINI FREIDMAN FONGEURS



Delicate, 2 x 8 mm bite, 6" (15 cm).

Catalog #	Description
GS47263	Straight
GS47264	Curved

FRIEDMAN RONGEUR



Catalog #	Description
GS47262	Curved, delicate, 4 x 11 mm bite, 5-3/4" (14.5 cm)

RONGEURS

Single Action Design

ORTHOPEDIC INSTRUMENTS

LEINERT-KUTZ SYNOVECTOMY RONGEUR



Catalog #
065202

Description
25 degrees strongly curved, 5-1/4" (13.5 cm)

BANE RONGEUR



Catalog #
GS47310

Description
Curved, 3 x 16 mm bite, 7" (18 cm)

RONGEURS

Single Action Design

DEAN RONGEUR



Catalog #
GS47286

Description
Curved, 3 mm bite, 5-3/4" (14.5 cm)

CHICHIRELLI (BLUMENTHAL) RONGEUR



Catalog #
GS47267

Description
Curved 45 degrees, 4 x 13 mm bite, 6" (15 cm)

RONGEURS

Single Action Design

ORTHOPEDIC INSTRUMENTS

MACON RONGEUR



Catalog #	Description
GS47308	Curved on side, 5 x 15 mm bite, 8" (20.5 cm)

LEMPERT RONGEURS



Delicate, 3 x 7 mm bite.

Catalog #	Description
GS47258	Straight, 6" (15 cm)
GS47260	Curved, 6" (15 cm)
GS47254	Straight, 7-1/2" (19 cm)
GS47256	Curved, 7-1/2" (19 cm)

RONGEURS

Single Action Design

BEYER BONE BITING RONGEUR



Catalog #	Description
028120	Curved jaw, 16 x 3 mm cup, 6-3/4" (17 cm)

DEAN (BLUMENTHAL) RONGEURS



4 x 11 mm, 6" (15 cm).

Catalog #	Description
GS47266	Curved 30 degrees
GS47268	Curved 90 degrees

RONGEURS

Single Action Design

ORTHOPEDIC INSTRUMENTS

WARTMANN RONGEUR

Catalog #
GS47285Description
Curved, 4 x 14 mm bite, 7-1/4" (18.5 cm)

MEAD RONGEUR

Catalog #
GS47276Description
Curved, 5 x 13 mm bite, 6-1/2" (16.5 cm)

RONGEURS

Single Action Design

ADSON RONGEURS



7 x 15 mm bite, 8" (20.5 cm).

Catalog #	Description
GS47302	Straight
GS47306	Curved

ADSON RAT TOOTH RONGEUR



Teeth facilitate easier bone excision.

Catalog #	Description
GS47304	Straight with teeth, 8 x 15 mm bite, 8" (20.5 cm)

RONGEURS

Single Action Design

ORTHOPEDIC INSTRUMENTS

EUR RONGEURS



8 x 12 mm bite, 7-1/8" (18 cm).

Catalog #	Description
GS47278	Straight
GS47284	Curved

Double Action Design

KLEINERT-KUTZ SYNOVECTOMY RONGEUR



Catalog #	Description
GS47553	Curved on side, delicate, 2 x 10 mm bite, 6" (15 cm)

RONGEURS

Double Action Design

KLEINERT-KUTZ SYNOVECTOMY RONGEUR



Catalog #	Description
GS47558	Fully curved, delicate, 3 mm bite, 6-1/8" (15.5 cm)

KLEINERT-KUTZ SYNOVECTOMY RONGEURS



Delicate, 6-1/8" (15.5 cm).

Catalog #	Description
GS47560	Curved, 2 mm bite
GS47562	Curved, 3 mm bite

RONGEURS

Double Action Design

ORTHOPEDIC INSTRUMENTS

LEINERT-KUTZ DOUBLE ACTION RONGEUR



Catalog #
065212

Description
10 degrees lightly curved, 18.5 x 5 mm cup,
7-1/4" (18.5 cm)

BEYER RONGEURS



Curved, 7" (18 cm).

Catalog #
GS47520
GS47522

Description
3 x 14 mm bite
4 x 15 mm bite

GS47520

GS47522

RONGEURS

Double Action Design

RUSKIN RONGEURS



6" (15.5 cm).

Catalog #	Description
GS47523	Straight, 2 x 14 mm bite
GS47532	Straight, 3 x 15 mm bite
GS47533	Curved, 2 x 15 mm bite
GS47534	Curved, 3 x 15 mm bite



GS47523

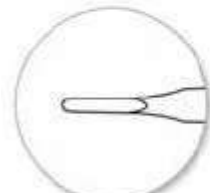

GS47523

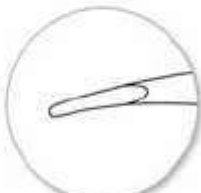

GS47533

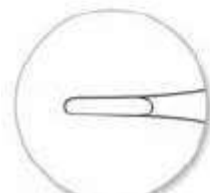

GS47532



GS47534

RUSKIN RONGEURS



7-1/4" (18.5 cm).

Catalog #	Description
GS47526	Straight, 4 x 16 mm bite
GS47528	Straight, 6 x 16 mm bite
GS47531	Curved, 6 x 16 mm bite



GS47528

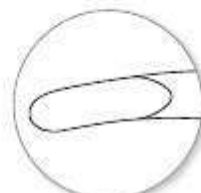

GS47531

GS47531

GS47527

RONGEURS

Double Action Design

ORTHOPEDIC INSTRUMENTS

MUSKIN RONGEUR

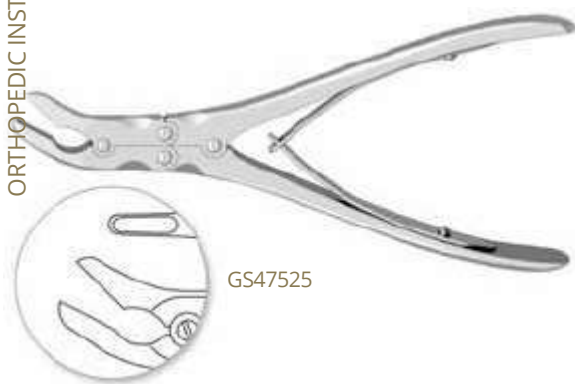
Catalog #
GS47525Description
Curved, 5 x 10 mm bite, 7-1/4" (18.5 cm)

RUSKIN RONGEUR

Catalog #
341836Description
Double action, curved, 4 mm bite, 6-1/8" (15.5 cm)

RONGEURS

Double Action Design

ZAUFAL-JANSEN RONGEUR



Catalog #
GS47524

Description
Curved, 5 x 15 mm bite, 7" (18 cm)

SMITH-PETERSON LAMINECTOMY RONGEUR



Catalog #
386152

Description
Double action, curved 15 degrees, 7-1/2" (19 cm)

RONGEURS

Double Action Design

ORTHOPEDIC INSTRUMENTS

SMITH-PETERSON LAMINECTOMY RONGEURS



GS47474

GS47474

GS47476

GS47478

3 x 16 mm bite, 9-1/2" (24 cm).

Catalog #	Description
GS47474	Straight
GS47476	Curved
GS47478	Full curved

RONGEURS

Double Action Design

LEKSELL RONGEURS

Curved 15 degrees, 9" (23 cm).



Catalog #	Description
GS47492	3 x 16 mm bite
GS47486	4.5 x 16 mm bite
GS47487	5 x 16 mm bite
GS47488	6 x 16 mm bite
GS47489	7 x 16 mm bite
GS47490	8 x 16 mm bite



GS47488

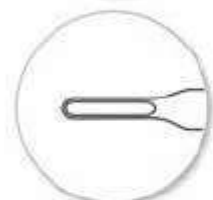

GS47492

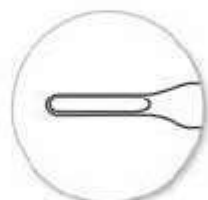

GS47486

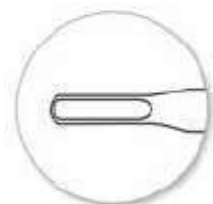

GS47487



GS47488



GS47489



GS47490

RONGEURS

Double Action Design

ORTHOPEDIC INSTRUMENTS

WIKSELL RONGEURS



Curved 50 degrees, 9-1/2" (24 cm).

Catalog #	Description
GS47494	3 x 13 mm bite
GS47495	4 x 13 mm bite
GS47497	5 x 13 mm bite
GS47498	6 x 13 mm bite
GS47499	7 x 13 mm bite
GS47496	8 x 16 mm bite

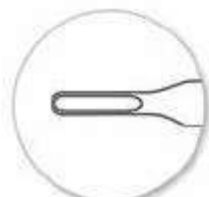

GS47494



GS47495



GS47497



GS47498



GS47499

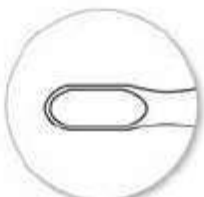

GS47496

RONGEURS

Double Action Design

ECHLIN DUCKBILL RONGEURS

Curved on side, 9" (23 cm).

Catalog #	Description
GS47480	2 x 12 mm bite
GS47482	3 x 12 mm bite
GS47484	4 x 12 mm bite

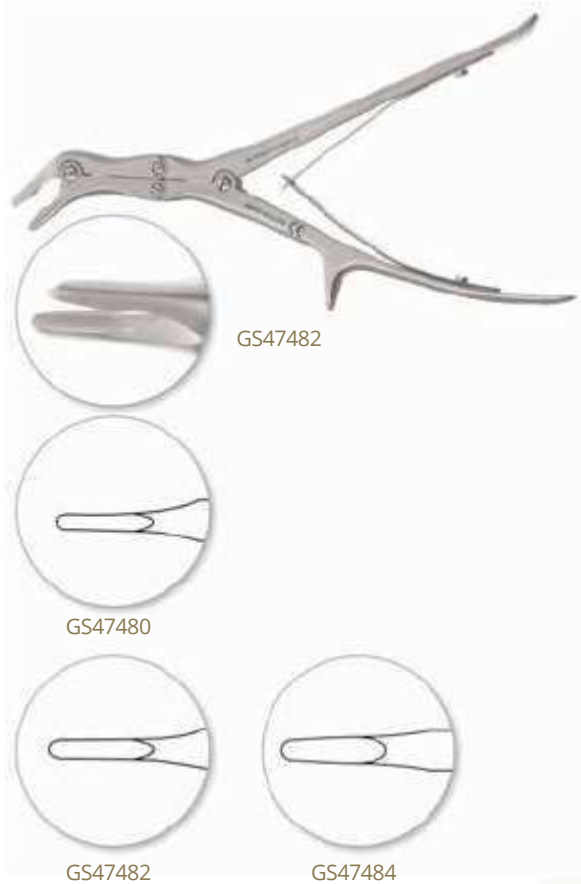

RONGEURS

Double Action Design

ORTHOPEDIC INSTRUMENTS

TILLE-LUER ECHLIN DUCKBILL RONGEURS



Curved on side, 9" (23 cm).

Catalog #	Description
GS47472	6 x 13 mm bite
GS47473	6 x 15 mm bite

RONGEURS

Double Action Design

STILLE-LEUR RONGEURS



GS47458

Catalog #	Description
GS47458	Straight, 10 x 18 mm, 8-1/2" (21.5 cm)
GS47462	Straight, 10 x 18 mm, 10-1/2" (26.5 cm)
GS47460	Curved, 10 x 18 mm, 8-3/8" (21 cm)
GS47464	Curved, 10 x 18 mm, 10-1/2" (26.5 cm)
GS47461	Curved on side, 10 x 16 mm, 8-1/2" (21.5 cm)

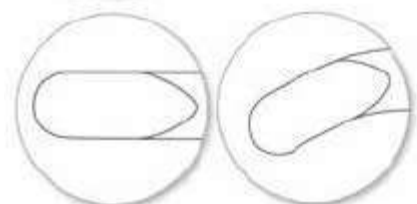

GS47458
GS47462

GS47460
GS47464



GS47461

RONGEURS

Double Action Design

ORTHOPEDIC INSTRUMENTS

HYPERT RONGEURS



GS47380

14" (35.5 cm).

Catalog #	Description
GS47380	4x16mm
GS47382	5x16mm
GS47384	8x16mm
GS47386	12 x 16 mm

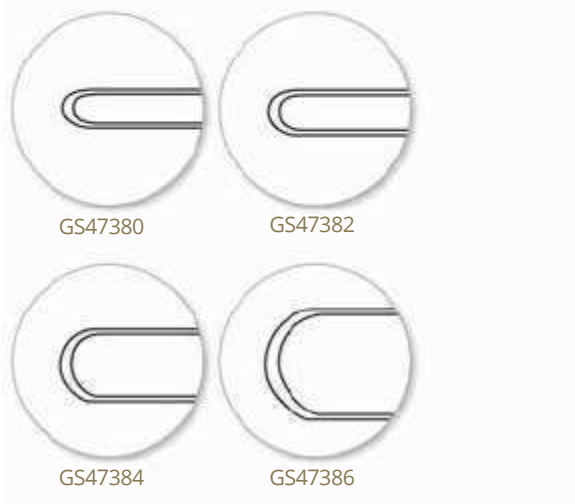

GS47380

GS47382

GS47384

GS47386

SPINAL RONGEURS AND PUNCHES

SHAFT LENGTH measured in closed position



IDENTIFICATION CHART

BITE STYLES punch jaws, thin footplate



Forward 40°

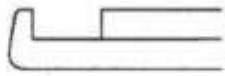

Up 90°

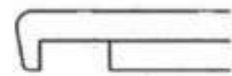

Down 90°

BITE STYLES punch jaws, regular footplate



Forward 40°

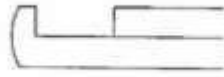

Up 90°

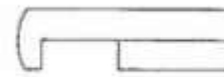

Down 90°

BITE STYLES cup jaws

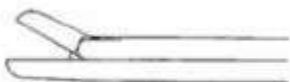

Straight

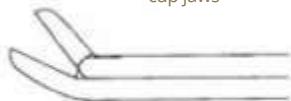

Up



Down

PUNCH JAWS



Foot plate

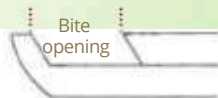

Bite opening

Bite size



Bite size is etched on handles of spinal rongeurs and punches

Handle Styles

ORTHOPEDIC INSTRUMENTS

STYLE I
Ring Handle
Handle Height 4"



STYLE II
Kerrison Handle
Handle Height 6-1/4"



STYLE III
Love-Kerrison Handle
(Cherry)
Handle Height 6"



STYLE IV
Large Kerrison Handle
Handle Height 6-1/4"



STYLE V
Small Kerrison Handle
Handle Height 5"



STYLE VI
Ferris-Smith
Kerrison Ring Handle
Handle Height 5"



STYLE VII
Spurling Kerrison Handle
Handle Height 4-3/4"
Wider grip improves
comfort and control.



STYLE VIII
Medium Kerrison Handle
Handle Height 5-1/4"



All Spinal Rongeurs and Punches have bite size etched on handles for easy identification

CLEANPUNCH® RONGEURS



- The first Kerrison that can be completely cleaned—eliminating all debris between shafts
- Precise cutting action—surgery proceeds smoothly
- Easily disassembles and reassembles—all parts remain connected
- A Teleflex® exclusive—advanced patented design

In most punches, tissue and debris can be trapped between the top and bottom shafts. This “buildup” is not only unsanitary, but adversely affects the functioning of the instruments, which slows down procedures and can distract the surgeon. This problem is caused by the common punch design, which does not allow parts to be disassembled and properly cleaned.

The CleanPunch® Rongeur is the first Kerrison that easily disassembles and reassembles to ensure surgeons benefit from a clean, smooth cutting action. The product of fine craftsmanship and superior technology, the CleanPunch® Rongeur — like all Certified Instruments—is designed and manufactured to perform impeccably.

COMPLETELY CLEAN

With total access to the top shaft, debris is quickly removed. Cleaning requires no scraping or “excavating,” which can damage an instrument and delay surgery.

SIMPLE TO OPEN AND CLOSE

To open, simply turn knob arrow to “open” and pull back the top slider. To close, align top slider and bottom shaft, push slider forward, and turn knob arrow back to “close.”

Patent Number: 5,961,531

REMAINS IN ONE PIECE

The CleanPunch® Rongeur remains in one piece throughout disassembly and reassembly. Patented design ensures there’s no possibility of losing or switching parts.

ERGONOMIC DESIGN

The custom-designed handle has a wider grip for optimum control and comfort. In addition, it reduces fatigue and enhances concentration.

GREATER FLEXIBILITY

The CleanPunch® Rongeur is available in 7" and 8" shaft lengths with regular and thin footplates, from 1 mm to 5 mm bites.

A TELEFLEX® EXCLUSIVE

The patented CleanPunch® Rongeur conforms to the exacting standards that distinguish all Certified Instruments.

CLEANPUNCH® RONGEUR

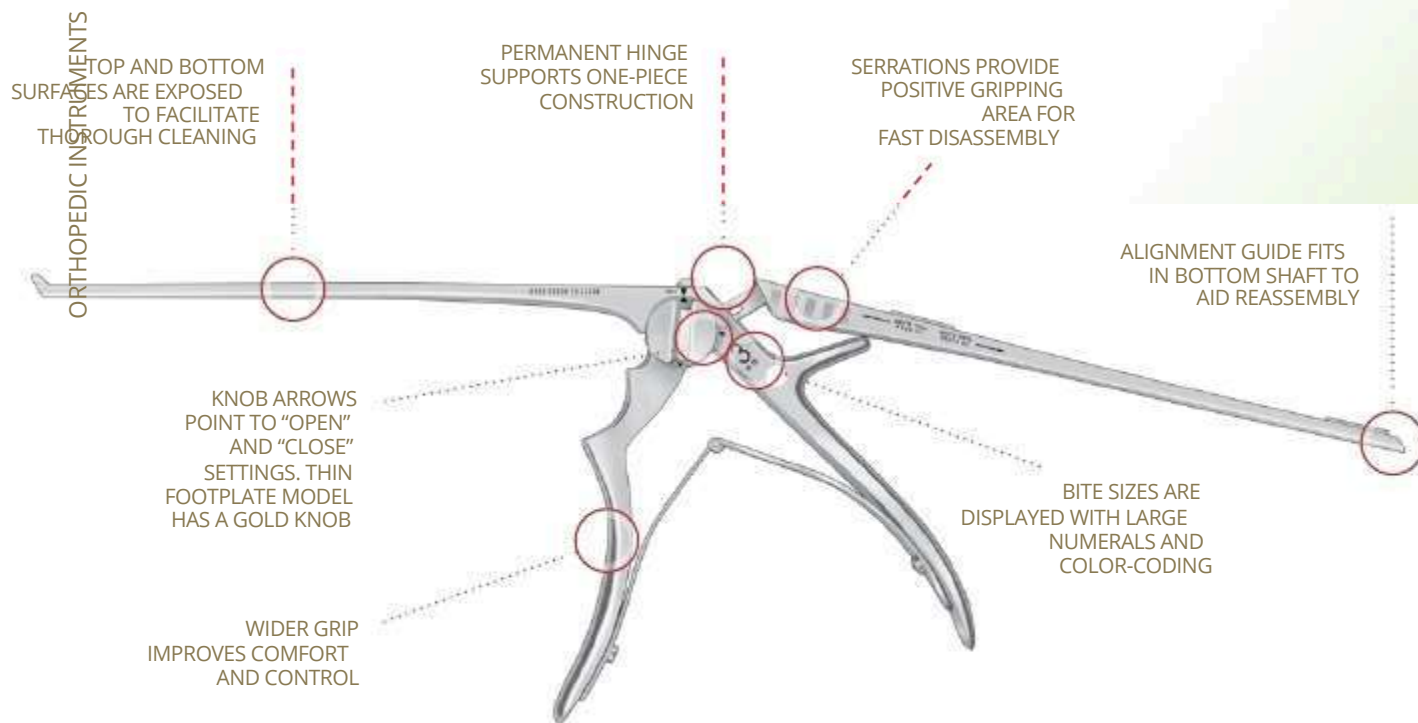

FEATURES AND BENEFITS:

- Patented design enables the instrument to be completely cleaned, eliminating the "buildup" of bone, tissue and fluids that cause sticking and resistance to action.
- Provides a consistently smooth cutting action.
- Eliminates distractions that interrupt a surgeon's concentration required in delicate spinal procedures.
- Instant identification enables surgeons to quickly locate the right bite size. Large, legible mm sizes are etched on handles, as well as color coded.

COLOR-CODED FOR INSTANT BITE SIZE RECOGNITION

- 1 mm - Red
- 2 mm - Blue
- 3 mm - Yellow
- 4 mm - Black
- 5 mm - Green
- 6 mm - White

HANDLING THE CLEANPUNCH® RONGEUR

TO OPEN:

1. Hold punch in left hand. Turn knob to "open" position (align arrows).
2. Push knob up with left thumb. Grip top slider on serrations with right hand and pull back.
3. Clean interior surfaces.

TO CLOSE:

1. Put knob in "open" position.
2. Align guides on top slider.
3. Push top slider forward until it clicks into place.
4. Turn knob to "close" position.
5. Test for proper functioning

RONGEURS

Kerrison Rongeurs — CleanPunch® 2

KERRISON CLEANPUNCH® 2 LAMINECTOMY RONGEURS



Handle style VII, thin footplate, 7" (18 cm).

Catalog #	Bite	size
GS59300	Forward	1mm
GS59303	Forward	2mm
GS59306	Forward	3mm
GS59309	Forward	4mm
GS59312	Forward	5mm

KERRISON CLEANPUNCH® 2 LAMINECTOMY RONGEURS



Handle style VII, thin footplate, 8" (20.5 cm).

Catalog #	Bite	size
GS59313	Forward	1mm
GS59315	Forward	2mm
GS59316	Forward	3mm
GS59321	Forward	4mm
GS59322	Forward	5mm

CLEANPUNCH® CLEANING SYSTEM



- Holds six CleanPunches in open position for maximum exposure during cleaning.
- Lightweight anodized aluminum construction.
- Minimize footprint – compact design has removable lid that fits under rack.
- When open, instrument handles are exposed for quick identification and easy access in the OR.
- Silicone-coated brackets prevent metal to metal contact.
- Protects sharp cutting edge during cleaning.
- Fits inside a standard container or can be wrapped separately.

Catalog #	Description
GS59200	Approximately 13-1/2" x 7" x 6"

RONGEURS

Kerrison Rongeurs — Thin Footplate Design

ORTHOPEDIC INSTRUMENTS

CERVICAL KERRISON THIN FOOTPLATE RONGEURS



- Thin footplate designed specifically for small bone in the cervical area.
- Gold hexagonal screw denotes thin footplate.
- Bite size etched on handle for quick identification.
- Care should be taken when using delicate thin footplate punches.
- Do not twist or pry instrument while cutting
- Do not use on large bones.

See the Instructions For Use for all instructions and contraindications.



Handle style VII, thin footplate.

Catalog #	Bite	size	overall length
GS55891	Forward	1mm	6" (15 cm)
GS55892	Forward	2mm	6" (15 cm)
GS55895	Forward	3mm	6" (15 cm)
GS55898	Forward	4mm	6" (15 cm)
GS55901	Forward	5mm	6" (15 cm)
GS55904	Forward	1mm	7" (18 cm)
GS55908	Forward	2mm	7" (18 cm)
GS55911	Forward	3mm	7" (18 cm)
GS55914	Forward	4mm	7" (18 cm)
GS55917	Forward	5mm	7" (18 cm)
GS55925	Forward	1mm	8" (20.5 cm)
GS55926	Forward	2mm	8" (20.5 cm)
GS55927	Forward	3mm	8" (20.5 cm)
GS55928	Forward	4mm	8" (20.5 cm)
GS55929	Forward	5mm	8" (20.5 cm)
GS55905	Up	1mm	7" (18 cm)
GS55909	Up	2mm	7" (18 cm)
GS55912	Up	3mm	7" (18 cm)
GS55915	Up	4mm	7" (18 cm)
GS55918	Up	5mm	7" (18 cm)
GS55906	Down	1mm	7" (18 cm)
GS55910	Down	2mm	7" (18 cm)
GS55913	Down	3mm	7" (18 cm)
GS55916	Down	4mm	7" (18 cm)
GS55919	Down	5mm	7" (18 cm)

RONGEURS

Kerrison Rongeurs — Standard Design

LOVE-KERRISON LAMINECTOMY PUNCHES

Handle style IV, large handle, regular footplate.



Catalog #	Bite	size	overall length
GS47676	Forward	2mm	8" (20.5 cm)
GS47670	Forward	3mm	6" (15 cm)
GS47671	Forward	3mm	7" (18 cm)
GS47678	Forward	3mm	8" (20.5 cm)
GS47680	Forward	4mm	8" (20.5 cm)
GS47674	Forward	5mm	6" (15 cm)
GS47682	Forward	5mm	8" (20.5 cm)
GS47689	Forward	6mm	11" (28 cm)



RONGEURS

Kerrison Rongeurs — Standard Design

ORTHOPEDIC INSTRUMENTS

DOVE-KERRISON LAMINECTOMY PUNCHES



Handle style IV, large handle, regular footplate.

Catalog #	Bite	size	overall length
GS47644	Up	3mm	6" (15 cm)
GS47645	Up	4mm	6" (15 cm)
GS47646	Down	5mm	6" (15 cm)
GS47648	Down	3mm	6" (15 cm)
GS47649	Down	4mm	6" (15 cm)
GS47650		5mm	6" (15 cm)

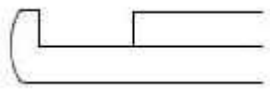

Up 90° Regular Footplate

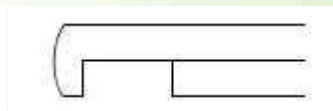

Down 90° Regular Footplate

RONGEURS

Kerrison Rongeurs — Standard Design

LOVE-KERRISON RONGEURS



Handle style II, large handle, regular footplate, 8" (20.5 cm).

Catalog #	Bite	Size
GS47620	Forward	1mm
GS47621	Forward	2mm
GS47622	Forward	3mm
GS47623	Forward	4mm
GS47624	Forward	5mm

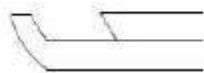

Forward 40° Regular Footplate

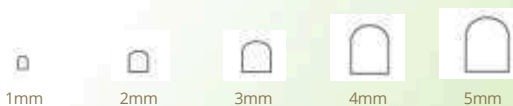

SR 47560 CU, Old

G S47620

G S47621

G S47622

G S47623

G S47624

RONGEURS

Kerrison Rongeurs — Standard Design

ORTHOPEDIC INSTRUMENTS

DOVE-KERRISON LAMINECTOMY PUNCHES



Handle style IV, large handle, regular footplate.

Catalog #	Bite	size	overall length
GS47644	Up	3mm	6" (15 cm)
GS47645	Up	4mm	6" (15 cm)
GS47646	Up	5mm	6" (15 cm)
GS47648	Down	3mm	6" (15 cm)
GS47649	Down	4mm	6" (15 cm)
GS47650	Down	5mm	6" (15 cm)
GS47652	Up	3mm	8" (20.5 cm)
GS47853	Up	4mm	8" (20.5 cm)
GS47654	Up	5mm	8" (20.5 cm)
GS47656	Down	3mm	8" (20.5 cm)
GS47657	Down	4mm	8" (20.5 cm)
GS47658	Down	5mm	8" (20.5 cm)

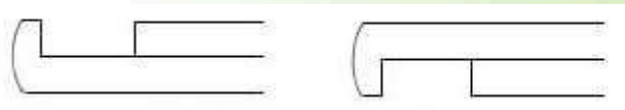

Up 90° Regular Footplate

Down 90° Regular Footplate



3mm

4mm

5mm

SPURLING-KERRISON PUNCHES



Handle style IV, regular footplate, 8" (20.5 cm).

Catalog #	Bite	size
GS55870	Forward	3mm
GS55871	Forward	4mm
GS55872	Forward	5mm

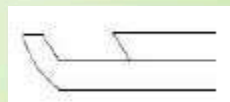

Forward 40° Regular Footplate



3mm

4mm

5mm

RONGEURS

Kerrison Rongeurs — Standard Design

SPURLING-KERRISON PUNCHES



Compact handle design to accommodate smaller hands.
Handle style V, regular footplate.

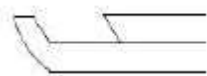

Forward 40° Regular Footplate

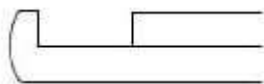

Up 90° Regular Footplate

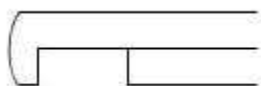

Down 90° Regular Footplate



Catalog #	Bite	size	overall length
GS47879	Forward	1mm	7" (18 cm)
GS47996	Forward	2mm	7" (18 cm)
GS48024	Forward	2mm	8" (20.5 cm)
GS47685	Forward	2mm	11" (28 cm)
GS47997	Forward	3mm	7" (18 cm)
GS48025	Forward	3mm	8" (20.5 cm)
GS47686	Forward	3mm	11" (28 cm)
GS47998	Forward	4mm	7" (18 cm)
GS48026	Forward	4mm	8" (20.5 cm)
GS47687	Forward	4mm	11" (28 cm)
GS47999	Forward	5mm	7" (18 cm)
GS48027	Forward	5mm	8" (20.5 cm)
GS47688	Forward	5mm	11" (28 cm)
GS47855	Forward	6mm	7" (18 cm)
GS48028	Forward	6mm	8" (20.5 cm)
GS48029	Forward	6mm	11" (28 cm)
GS47988	Up	2mm	7" (18 cm)
GS48016	Up	2mm	8" (20.5 cm)
GS47989	Up	3mm	7" (18 cm)
GS48017	Up	3mm	8" (20.5 cm)
GS47990	Up	4mm	7" (18 cm)
GS48018	Up	4mm	8" (20.5 cm)
GS47991	Up	5mm	7" (18 cm)
GS48019	Up	5mm	8" (20.5 cm)
GS47857	Up	6mm	7" (18 cm)
GS47992	Down	2mm	7" (18 cm)
GS48020	Down	2mm	8" (20.5 cm)
GS47993	Down	3mm	7" (18 cm)
GS48021	Down	3mm	8" (20.5 cm)
GS47994	Down	4mm	7" (18 cm)
GS48022	Down	4mm	8" (20.5 cm)
GS47995	Down	5mm	7" (18 cm)
GS48023	Down	5mm	8" (20.5 cm)
GS47856	Down	6mm	7" (18 cm)

RONGEURS

Kerrison Rongeurs — Standard Design

ORTHOPEDIC INSTRUMENTS

CHLESINGER CERVICAL LAMINECTOMY RONGEURS



GS47612

Handle style IV, large handle, regular footplate, 6" (15 cm).

Catalog #	Bite	size
GS47610	Up	3mm
GS47612	Up	5mm
GS47614	Down	3mm
GS47616	Down	5mm

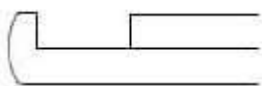

Up 90° Regular Footplate

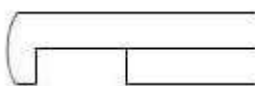

Down 90° Regular Footplate



3mm

4mm



5mm

FERRIS-SMITH KERRISON RONGEURS



GS48041

Handle style IV, thin footplate, 7" (18 cm).

Catalog #	Bite	size
GS48041	Down	6mm

Down 90°
Thin Footplate 6mm

RONGEURS

Kerrison Rongeurs — Standard Design

FERRIS-SMITH KERRISON RONGEURS



GS48010

Handle style V, regular footplate.

Catalog #	Bite	size	overall length
GS48010	Forward	1mm	6" (15 cm)
GS47987	Up	6mm	7" (18 cm)

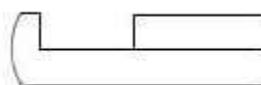

Up 90° Regular Footplate



1mm

FERRIS-SMITH KERRISON PUNCHES



GS55823

Ring handle (handle style VI), regular footplate.

Catalog #	Bite	size	overall length
GS55813	Forward	3mm	7" (18 cm)
GS55823	Forward	3mm	8" (20.5 cm)
GS55815	Forward	5mm	7" (18 cm)
GS55825	Forward	5mm	8" (20.5 cm)

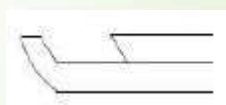

Forward 40° Regular Footplate



3mm



5mm

RONGEURS

Kerrison Rongeurs — Standard Design

ORTHOPEDIC INSTRUMENTS

KERRIS-SMITH ENDOSCOPIC KERRISON RONGEURS



GS55788

Graduated tip, ring handle, 3-1/4" tip length, .470" shaft diameter, working length 14" (35.5 cm), overall 20" (51 cm).

Catalog #	Bite	size
GS55788	Forward	2.5
GS55790	Forward	mm
GS55782	Down	4mm
		4mm



2.5 mm GS55788

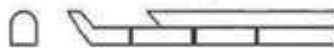

4mm GS55790



4mm GS55782

KERRISON RONGEUR



411625

Catalog #	Bite	size	overall length
411625	Up	3mm	3-1/2" (9 cm)

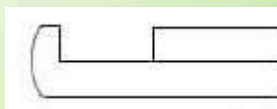

Up 90° Regular Footplate



3mm

RONGEURS

Kerrison Rongeurs — Standard Design

KERRISON MULTI-BITE PUNCHES



Fenestrated upper shaft ejects cut pieces of bone and tissue. Delicate, thin footplate, for cervical use only, 7" (18 cm).

Catalog #	Bite
GS55980	Up, fenestrated
GS55981	Up, fenestrated



Up 90°
Thin Footplate



2mm



3mm

MOORELAND RONGEUR



Catalog #	Description
GS47850	5 x 15 mm, 13-3/4" (35 cm)

FORAMINOTOMY PUNCHES



Handle style V, regular footplate, 8" (20.5 cm).

Catalog #	Bite	size
GS48030	Curved up	2mm
GS48033	Curved up	3mm
GS48032	Curved up	4mm



2mm



3mm



4mm

RONGEURS

IVD Rongeurs

ORTHOPEDIC INSTRUMENTS

WECKER IVD RONGEUR



Catalog #
GS55858

Bite
Straight

size
2x6mm

overall length
6" (15 cm)

PEAPOD IVD RONGEUR



Catalog #
GS55842

Bite
Up angle

size
2x6mm

overall length
5-1/2" (14 cm)

SELVERSTONE IVD RONGEUR



Catalog #
GS55860

Bite
Straight

size
2x3mm

overall length
6" (15 cm)

RONGEURS

IVD Rongeurs

WILDE IVD RONGEURS



Fenestrated jaws, straight.

Catalog #	Description	overall length
GS47707	Small, 4 x 9 mm bite	5" (12.5 cm)
GS47708	Medium, 5 x 10 mm bite	5" (12.5 cm)
GS47709	Large, 6 x 11 mm bite	5" (12.5 cm)

CUSHING IVD RONGEURS



Catalog #	Bite	size	overall length
GS47710	Straight	2x10mm	5" (12.5 cm)
GS47730	Straight Up	2x10mm	7" (18 cm)
GS47712	angle Up	2x10mm	5" (12.5 cm)
GS47732	angle Down	2x10mm	7" (18 cm)
GS47714	angle	2x10mm	5" (12.5 cm)
GS47734	Down angle	2x10mm	7" (18 cm)

LOVE-GRUENWALD IVD RONGEURS



Catalog #	Bite	size	overall length
GS47760	Straight	3x10mm	5" (12.5 cm)
GS47780	Straight	3x10mm	7" (18 cm)
GS47762	Up angle	3x10mm	5" (12.5 cm)
GS47782	Up angle	3x10mm	7" (18 cm)
GS47764	Down angle	3x10mm	5" (12.5 cm)
GS47784	Down angle	3x10mm	7" (18 cm)

RONGEURS

IVD Rongeurs

ORTHOPEDIC INSTRUMENTS

WECKER IVD RONGEUR



GS55858

Catalog #
GS55858Bite
Straightsize
2x6mmoverall length
6" (15 cm)

PEAPOD IVD RONGEUR



GS55842

Catalog #
GS55842Bite
Up anglesize
2x6mmoverall length
5-1/2" (14 cm)

SELVERSTONE IVD RONGEUR



GS55860

Catalog #
GS55860Bite
Straightsize
2x3mmoverall length
6" (15 cm)

RONGEURS

IVD Rongeurs

ORTHOPEDIC INSTRUMENTS

CURLING IVD RONGEURS



Catalog #	Bite	size	overall length
GS47800	Straight	4x10mm	5" (12.5 cm)
GS47840	Straight	4x10mm	7" (18 cm)
GS47802	Up angle	4x10mm	5" (12.5 cm)
GS47842	Up angle	4x10mm	7" (18 cm)
GS47804	Down angle	4x10mm	5" (12.5 cm)
GS47844	Down angle	4x10mm	7" (18 cm)

CASPAR IVD RONGEURS



Fenestrated jaw, serrated cup.

Catalog #	Bite	size	overall length
GS55935	Straight	2x12mm	6-1/4" (16 cm) 6-
GS55936	Straight	3x12mm	1/4" (16 cm) 6-
GS55937	Straight	4x14mm	1/4" (16 cm) 6-
GS55938	Straight	5x14mm	1/4" (16 cm) 7-
GS55960	Straight	2x12mm	1/4" (18.5 cm) 7-
GS55961	Straight	3x12mm	1/4" (18.5 cm) 7-
GS55962	Straight	4x14mm	1/4" (18.5 cm) 7-
GS55963	Straight	5x14mm	1/4" (18.5 cm) 7-
GS55964	Straight	6x16mm	1/4" (18.5 cm) 7-
GS55972	Up angle	3x12mm	1/4" (18.5 cm) 7-
GS55973	Up angle	4x14mm	1/4" (18.5 cm) 7-
GS55974	Up angle	5x14mm	1/4" (18.5 cm) 7-
GS55966	Down angle	3x12mm	1/4" (18.5 cm) 7-
GS55967	Down angle	4x14mm	1/4" (18.5 cm)



2x12mm
bite straight
GS55935
GS55960



3x12mm
bite straight
GS55936
GS55961



4x14mm
bite straight
GS55937
GS55962



5x14mm
bite straight
GS55938
GS55963

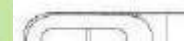

6x16mm
bite straight
GS55964

bite up angle
GS55972

bite up angle
GS55973

bite up angle
GS55974

bite down angle
GS55966

bite down angle
GS55967

RONGEURS

IVD Rongeurs

CASPAR IVD RONGEURS



6" (15 cm).

Catalog #	Bite	size
GS55946	Straight	2x10mm
GS55947	Straight	3x10mm
GS55948	Straight	4x10mm
GS55949	Straight	5x10mm
GS55952	Up angle	2x10mm
GS55953	Up angle	3x10mm
GS55954	Up angle	4x10mm
GS55940	Down angle	2x10mm
GS55941	Down angle	3x10mm
GS55942	Down angle	4x10mm



2x10mm

bite straight
GS55946

bite up angle
GS55952

bite down angle
GS55940



3x10mm

bite straight
GS55947

bite up angle
GS55953

bite down angle
GS55941



4x10mm

bite straight
GS55948

bite up angle
GS55954

bite down angle
GS55942



5x10mm

bite straight
GS55949

SCHLESINGER IVD RONGEURS



Serrated jaws.

Catalog #	Bite	size	overall length
GS47700	Straight	2x10mm	6" (15 cm)
GS47702	Straight	3x10mm	6" (15 cm)
GS47704	Straight	4x10mm	6" (15 cm)
GS47703	Up	GS47703 3x10mm	6" (15 cm)



GS47700 GS47700
2x10mm

bite straight
GS47700



GS47702
3x10mm

bite straight
GS47702

bite up angle
GS47703
GS47704

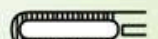

GS47703
4x10mm

bite straight
GS47704

GS47703

GS47702 GS47702

RONGEURS

IVD Rongeurs

ORTHOPEDIC INSTRUMENTS

WACHLESINGER IVD RONGEURS



9" (23 cm).

Catalog #

GS55690

GS55691

GS55693

GS55694

Bite

Straight

Straight

Up angle

Up angle

size

3x10mm

5x10mm

3x10mm

5x10mm

OLDBERG IVD RONGEUR



Catalog #

GS55856

Bite

Round

size

6mm

overall length

7" (18 cm)

RONGEURS

IVD Rongeurs

FERRIS-SMITH IVD RONGEURS



Ring handle lessens chance of slippage.
Handle style VI, 7" (18 cm) shaft.

Catalog #	Bite	size
GS47858	Straight	2x10mm
GS47864	Straight	3x10mm
GS47870	Straight	4x10mm
GS47878	Straight	6x12mm
GS47860	Up angle	2x10mm
GS47866	Up angle	3x10mm
GS47872	Up angle	4x10mm
GS47873	Up angle	6x12mm
GS47862	Down angle	2x10mm
GS47868	Down angle	3x10mm
GS47874	Down angle	4x10mm
GS47875	Down angle	6x12mm



2x10mm
bite straight
GS47858

bite up
GS47860
bite down
GS47862



3x10mm
bite straight
GS47864

bite up
GS47866
bite down
GS47868



4x10mm
bite straight
GS47870

bite up
GS47872
bite down
GS47874



6x12mm
bite straight
GS47878

bite up
GS47873
bite down
GS47875

FERRIS-SMITH ENDOSCOPIC IVD RONGEURS



Handle style VI, ring handle, 3-1/4" tip length,
0.470" (12 mm) shaft diameter, 10-3/4" shaft length,
6" handle length, 20" (51 cm).

Catalog #	Bite	size
GS55762	Straight	2.5 x 10 mm
GS55763	Straight	4x10mm
GS55767	Up angle	4x10mm
GS55777	Straight, serrated	8x12mm



GS55762



GS55763



GS55767

BENDING IRONS AND ROD HOLDERS

BENDING IRONS AND ROD HOLDERS

ORTHOPEDIC INSTRUMENTS

UNIVERSAL ROD BENDER



GS46664

CATALOG #	Description
GS46664	11-1/4" (28.5 cm)

IN SITU ROD BENDERS



GS49780



GS49781

Used in pairs, 13" (33 cm).

CATALOG #	Description
GS49780	Right, bends 3/16" (4.76 mm) rods
GS49781	Left, bends 3/16" (4.76 mm) rods
GS49782	Right, bends 1/4" (6.35 mm) rods
GS49783	Left, bends 1/4" (6.35 mm) rods

ONE-HANDED ROD BENDER



GS49812

For 3 mm and 4 mm diameter rods.

CATALOG #	Description
GS49812	7-1/2" (19 cm)

BENDING IRONS AND ROD HOLDERS

ROD HOLDERS



GS49830

With ratchet, 7-1/4" (18.5 cm).

CATALOG #	Description
GS49830	Holds 5/32" (4.0 mm) rods
GS49831	Holds 3/16" (4.76 mm) rods
GS49832	Holds 1/4" (6.35 mm) rods

ROD HOLDERS



GS49706

Curved tip, with ratchet, 8-1/4" (21 cm).

CATALOG #	Description
GS49701	Threaded hole, holds 5/32" (4.0 mm) rods
GS49702	Threaded hole, holds .177" (4.5 mm) rods
GS49706	Without threaded hole, holds .197" (5.0 mm) rods

ROD HOLDER

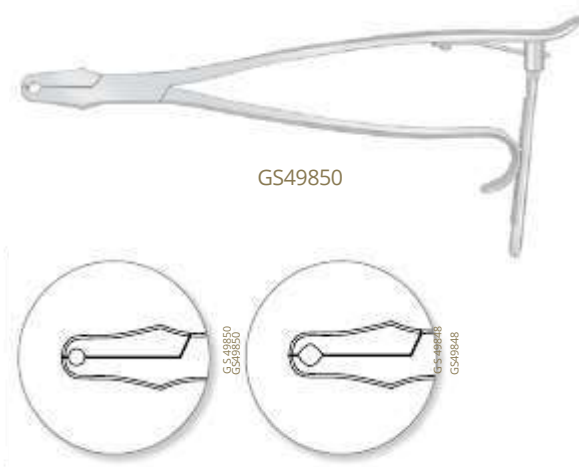

GS49850

With ratchet, 10" (25.5 cm).

CATALOG #	Description
GS49850	Holds 1/4" (6.35 mm) rods, threaded hole
GS49848	Prism holds 0.197" (5 mm) and 5.5 mm rods

BENDING IRONS AND ROD HOLDERS

ORTHOPEDIC INSTRUMENTS

MINI PLATE BENDING IRON



GS47917

For mini and finger plates.

CATALOG #	Description
GS47917	4-3/4"

SMALL PLATE BENDING IRONS



GS47916

Used in pairs. For 3.5 mm and 2.7 mm plates.

CATALOG #	Description
GS47916	5-1/2" (14 cm)
GS47915	5-1/2" (14 cm)



GS47915

STANDARD PLATE BENDING IRON



GS47918

For standard plates, with 4 holes.

CATALOG #	Description
GS47918	9-1/2"

BENDING IRONS AND ROD HOLDERS

PLATE BENDING IRON



CATALOG #	Description
GS47919	For 3.5 mm and 4.5 mm plates

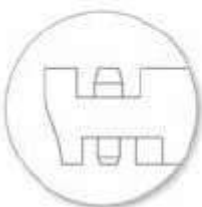

GS47919

BENDING IRONS



CATALOG #	Description
GS45501	For 0.8 - 1.25 mm K-Wires, 4-1/2" (11.5 cm)
GS45502	For 1.25, 1.6 and 2 mm K-Wires, 4-3/4" (12 cm)

GS45501

PLATE HOLDING CLIPS

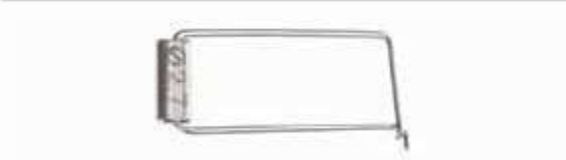

CATALOG #	Description
GS47962	2.0 mm
GS47963	2.7 mm
GS47964	3.5 mm

GS47963

BONE CUTTING FORCEPS

GENERAL

BONE CUTTING FORCEPS

ORTHOPEDIC INSTRUMENTS

LYSTON BONE CUTTING FORCEPS



GS47402

Catalog #	Description
GS47398	Straight, 5-1/2" (14 cm)
GS47410	Angled on flat, 5-1/2" (14 cm)
GS47400	Straight, 6-3/4" (17 cm)
GS47404	Angled on flat, 6-3/4" (17 cm)
GS47402	Straight, 7-7/8" (20 cm)
GS47412	Angled, 7-7/8" (20 cm)
GS47406	Straight, 8-5/8" (22 cm)
GS47408	Angled on flat, 8-1/2" (22 cm)

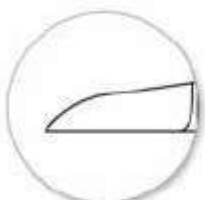

GS47398



GS47410

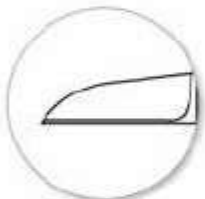

GS47400



GS47404



GS47402



GS47412

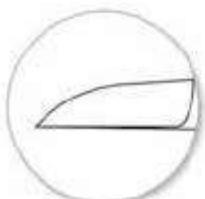

GS47406



GS47408

BONE CUTTING FORCEPS

RUSKIN-LISTON BONE CUTTING FORCEPS

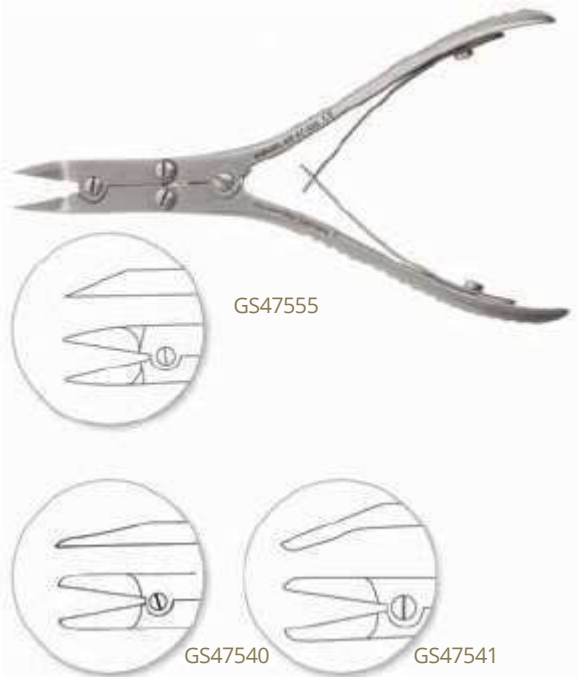

Delicate blades.

Catalog #	Description
GS47555	Straight, 5-5/8" (15 cm)
GS47557	Angled, 5-1/2" (14 cm)
GS47540	Straight, 7-1/8" (18 cm)
GS47541	Angled on flat, 7" (18 cm)

STILLE-LISTON BONE CUTTING FORCEPS



10-1/2" (27 cm).

Catalog #	Description
GS47366	Straight
GS47370	Angled on flat

BONE CUTTING FORCEPS

ORTHOPEDIC INSTRUMENTS

MUSKIN-LISTON BONE CUTTING FORCEPS

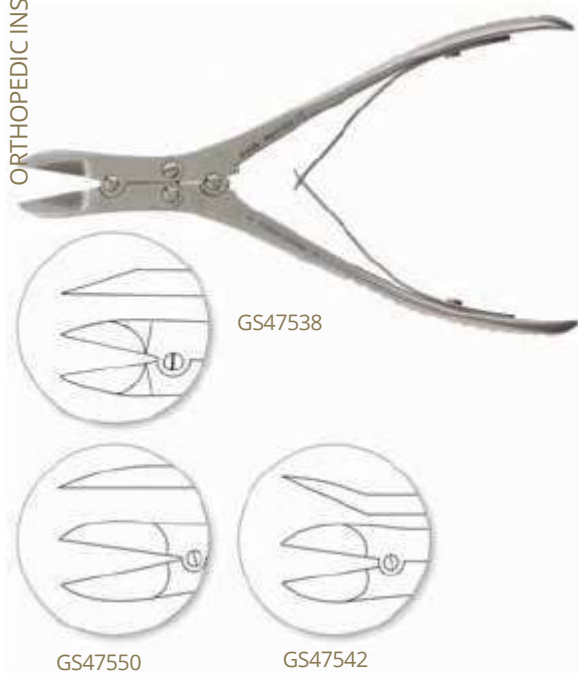

Catalog #	Description
GS47550	Straight, 6" (15 cm)
GS47538	Straight, 7-1/4" (19 cm)
GS47542	Angled, 7-1/4" (19 cm)

STILLE-HORSLEY BONE CUTTING FORCEPS



Catalog #	Description
GS47374	Angled, 9-3/8" (24 cm)

BONE FILES AND RASPS

BONE FILES AND RASPS

Bone Files

ORTHOPEDIC INSTRUMENTS

BONE FILE #10



GS69542

Catalog #
GS69542

Description
Double-ended, plain serrations, 5 mm width,
7-1/8" (18 cm)



BONE FILE #12



GS69543

Catalog #
GS69543

Description
Double-ended, plain serrations, 7 and 5 mm width,
7-1/8" (18 cm)

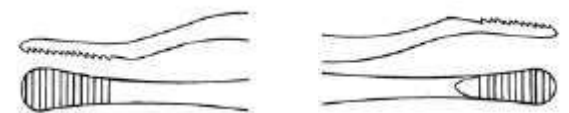

BONE FILE #12A



GS69544

Catalog #
GS69544

Description
Double-ended, plain and cross serrations, 5 mm
width, 7-1/8" (18 cm)

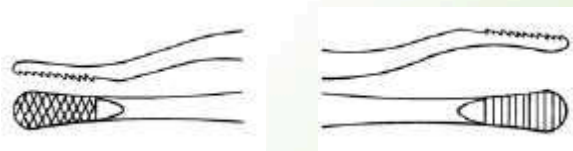

BONE FILES AND RASPS

Bone Files

BONE FILE #12CA



GS69545

Catalog #
GS69545

Description
Double-ended, cross serrations, 5 and 7 mm width,
7-1/8" (18 cm)

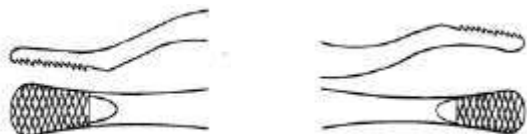

BONE FILE #33



GS69546

Catalog #
GS69546

Description
Double-ended, plain serrations, 6 and 5 mm width,
7-1/8" (18 cm)



BONE FILE #45



GS69549

Catalog #
GS69549

Description
Double-ended, plain serrations, 6 and 5 mm width,
7-1/4" (18.5 cm)



BONE FILES AND RASPS

Bone Files

ORTHOPEDIC INSTRUMENTS

BONE RASP #64



GS58070

Catalog #
GS58070

Description
Double-ended, plain serrations, 3 and 4 mm width,
7-1/8" (18 cm)

BONE FILE #92A



GS69530

Single-ended, delicate, plain serrations.

Catalog #
GS69530

Description
Angled downward

BONE FILE #92B



GS69534

Single-ended, delicate, plain serrations.

Catalog #
GS69534

Description
Angled upward

NAIL RASP #93



GS69538

Catalog #
GS69538

Description
Double-ended, 2 mm wide, angled, 6-3/4" (17 cm)

BONE FILES AND RASPS

Bone Rasps

ORTHOPEDIC INSTRUMENTS

AUFRICHT RASPS



Catalog #	Description
052162	Forward-cutting, 25 x 9 mm, 8" (20.5 cm)
GS58050	Forward-cutting, 8.5 mm wide, 8-1/4" (21 cm)
GS58052	Backward-cutting, 9 mm wide, 8-1/4" (21 cm)



AUFRICHT-GLABELLA RASP



Catalog #	Description
052165	Up and down-cutting, 9 x 30 mm, 7-1/2" (19 cm)

BONE RASP

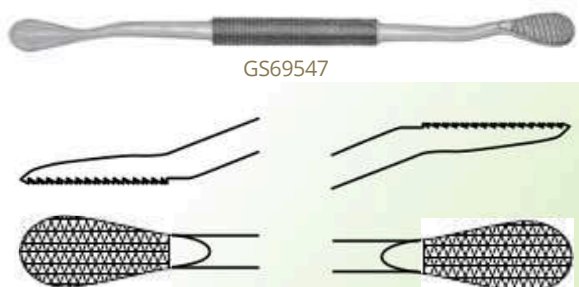

For rapid shaping of bone.

Catalog #	Description
GS69547	Double-ended, fine and coarse cross serrations, 13 mm wide, 8-1/2" (21.5 cm)

SRUCU, Old SR 69547 69547 CU, Old

BONE FILES AND RASPS

Bone Rasps

CONVERSE RASP



Catalog #
052180

Description
Double-ended, fine and coarse serrations,
7-1/8" (18 cm)



052180

COTTLE RASP



Catalog #
052130

Description
Straight down-cutting blade, 9 mm width,
8-1/4" (21 cm)

052130

FOMAN RASP



Description
Double-ended. Fine and coarse serrations. 4-sided,
convex and flat blades.

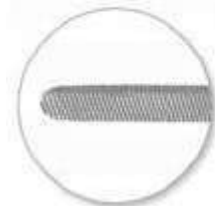

Catalog #
GS46655

Description
8-1/2" (21.5 cm)

GS46655

JOSEPH RASP



Catalog #
441530

Description
Fine serrations, 6-1/8" (15.5 cm)



441530

BONE FILES AND RASPS

Bone Rasps

ORTHOPEDIC INSTRUMENTS

KLEINERT-KUTZ BONE RASP



GS46653

Double-ended. Fine and coarse serrations. 4-sided, convex and flat blades.

Catalog #	Description
GS46653	8-7/8" (22.5 cm)

KLEINERT-KUTZ RASP



441555

Catalog #	Description
441555	4-sided tips, 7.5 mm wide, 8-5/8" (22 cm)

LEWIS RASPS



GS58072

Single-ended bayonet shank, plain serrations, 8 mm wide, 7-1/2" (19 cm).

Catalog #	Description
GS58072	Fine serrations
GS58073	Coarse serrations



GS58072



GS58073

BONE FILES AND RASPS

Bone Rasps

MALTZ RASP



Catalog #
052100

Description
Straight down-cutting blade, 6 mm width,
7-1/8" (18 cm)

052100

MALTZ RASP IMPROVED



Catalog #
GS58062

Description
Double-ended, forward and backward-cutting,
8 mm wide, 8-1/4" (21 cm)

GS58062

POLOKOFF BONE RASPS



Double-ended, plain serrations.

GS69540

Catalog #
GS69540 6 mm wide, 7-7/8" (20 cm)
GS69541 3 and 4 mm wide, 7-7/8" (20 cm)

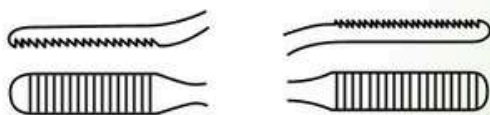

GS69540



GS69541

SR

BONE FILES AND RASPS

Rib Rasps

ORTHOPEDIC INSTRUMENTS

ALEXANDER PERIOSTEAL RASP



Catalog #
GS58110

Description
11 mm sharp, 8-1/8" (20.5 cm)

FARABEUF PERIOSTEAL RASPS



Single-ended, sharp, 5-7/8" (15 cm).

Catalog #
GS58106
GS58108

Description
Straight blade, 13 mm curved edge
Curved blade, 13 mm straight edge

KIRMISSION PERIOSTEAL RASP



Catalog #
GS58112

Description
Sharp, 6-3/4" (17 cm)

BONE HOLDING INSTRUMENTS

BONE HOLDING INSTRUMENTS

Bone Holding Forceps

ORTHOPEDIC INSTRUMENTS

HEWIN BONE HOLDING FORCEPS



GS47130

CATALOG #	Description
GS47130	Serrated, 7" (18 cm)

GLENOID PERFORATING FORCEPS



GS46911

GS46912

Pointed tips, 6-1/2" (17 cm).

CATALOG #	Description
GS46911	Slightly curved
GS46912	Strongly curved

BONE HOLDING INSTRUMENTS

Bone Holding Forceps

BONE HOLDING FORCEPS



For positioning K-Wire up to 0.035" (0.9 mm).

CATALOG #	Description
GS45302	Curved, with 0.035" (0.9 mm) K-Wire guide, 6-3/4" (17 cm)

BONE HOLDING FORCEPS



For positioning K-Wire up to 0.062" (1.6 mm).

CATALOG #	Description
GS45304	Curved, with 0.062" (1.6 mm) K-wire guide, 5-1/2" (14 cm)

BONE HOLDING INSTRUMENTS

Bone Holding Forceps

ORTHOPEDIC INSTRUMENTS

BONE HOLDING FORCEPS



GS45305

Curved, with K-Wire guide, 5" (13 cm).

CATALOG #	Description
GS45305	0.035" (0.9 mm)
GS45306	0.045" (1.1 mm)
GS45307	0.062" (1.6 mm)

LOCKE PHALANGEAL FORCEPS



GS69787

Very useful for removing the sesamoid bone.

CATALOG #	Description
GS69787	Serrated, 1 x 2 teeth, 6" (15 cm)

BONE HOLDING INSTRUMENTS

Bone Holding Forceps

BONE HOLDING FORCEPS

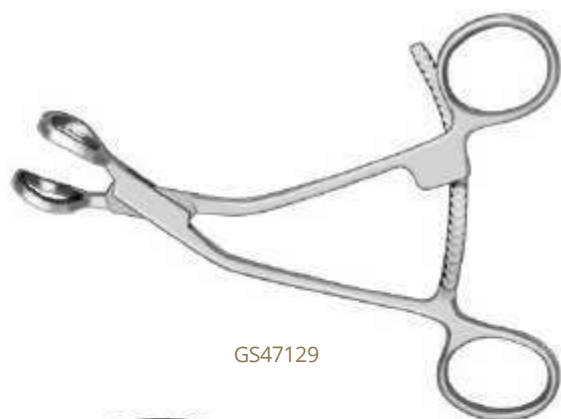

GS47129

Angled, with fenestration.

CATALOG #
GS47129

Description
Inside fenestration 22 x 14 mm, outside fenestration
30 x 20 mm, ratchet length 3" (76 mm), overall
length 6" (15 cm)

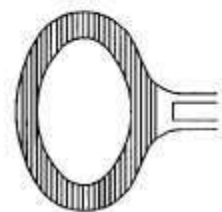

MALLEOLAR BONE HOLDING FORCEPS



GS47010

Grasping forceps for small bones.

CATALOG #
GS47010

Description
1 x 1 sharp points, 8-1/4" (21 cm)

BONE HOLDING INSTRUMENTS

Bone Holding Forceps

ORTHOPEDIC INSTRUMENTS

MARHAM-MARTIN BONE CLAMP



Fit thin end of band through slot in other end of band.
Insert thin end into clamp. 8-1/4" (21 cm).

CATALOG #	Description
GS47172	Bands not included
GS47173	Single band only

PLATE AND BONE HOLDING FORCEPS



For positioning small bone plates.

CATALOG #	Description
GS47138	5-3/8" (14 cm)

BONE HOLDING INSTRUMENTS

Bone Holding Forceps

PLATE AND BONE HOLDING FORCEPS



For positioning mini bone plates.

CATALOG #	Description
GS47139	1 pointed tip, 5-1/4" (14 cm)

GS47139

SEMB BONE HOLDING FORCEPS

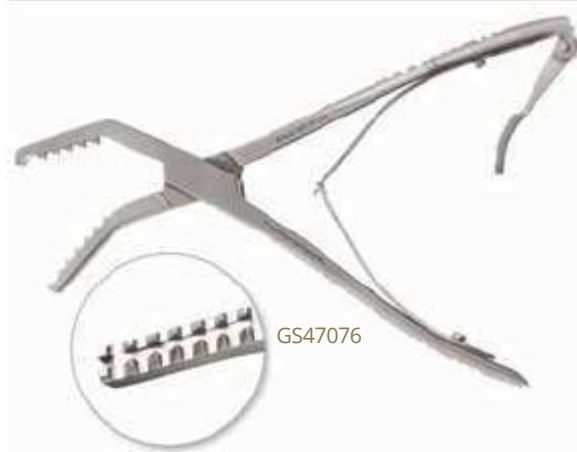

Curved sideways. Deep teeth.

CATALOG #	Description
GS47074	4 x 5 teeth, without ratchet, 7-1/2" (19 cm)
GS47076	5 x 5 teeth, with ratchet, 8" (21 cm)

GS47076

PATELLA BONE HOLDING FORCEPS

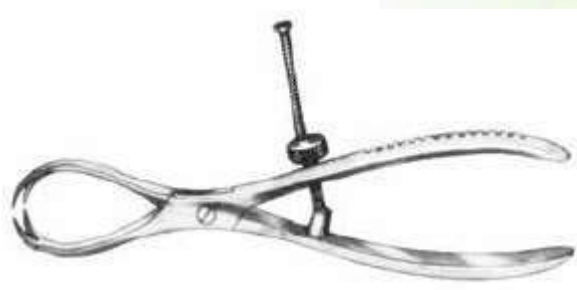

CATALOG #	Description
GS47012	2 x 2 sharp teeth, with speed lock, 7" (18 cm)

GS47012

BONE HOLDING INSTRUMENTS

Bone Holding Forceps

ORTHOPEDIC INSTRUMENTS

MAN BUREN SEQUESTERUM FORCEPS



CATALOG #	Description
GS47072	Curved sideways, serrated, 9" (23 cm)

GS47072

LANGENBECK BONE HOLDING FORCEPS



CATALOG #	Description
GS47200	2 x 2 teeth, 8-1/4" (21 cm)

GS47200

FARABEUF BONE HOLDING FORCEPS



Adjustable jaw.

CATALOG #	Description
GS47194	9" (23 cm)
GS47196	10" (25.5 cm)

GS47194

BONE HOLDING INSTRUMENTS

Bone Holding Forceps

FARABEUFLAMBOTTE BONE HOLDING FORCEPS



GS47190

Adjustable jaw.

CATALOG #	Description
GS47190	7-1/2" (19 cm)
GS47192	10-1/2" (27 cm)

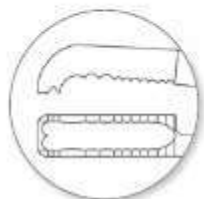

GS47190

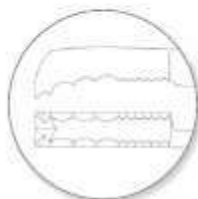

GS47192

FERGUSON BONE HOLDING FORCEPS



CATALOG #	Description
GS47198	Deep teeth, 8-1/4" (21 cm)



GS47198

FIBULA BONE HOLDING FORCEPS



With angled tip and speed lock.

CATALOG #	Description
GS47170	8-1/2" (22 cm)



GS47170

BONE HOLDING INSTRUMENTS

Bone Holding Forceps

ORTHOPEDIC INSTRUMENTS

WESTERN BONE HOLDING FORCEPS

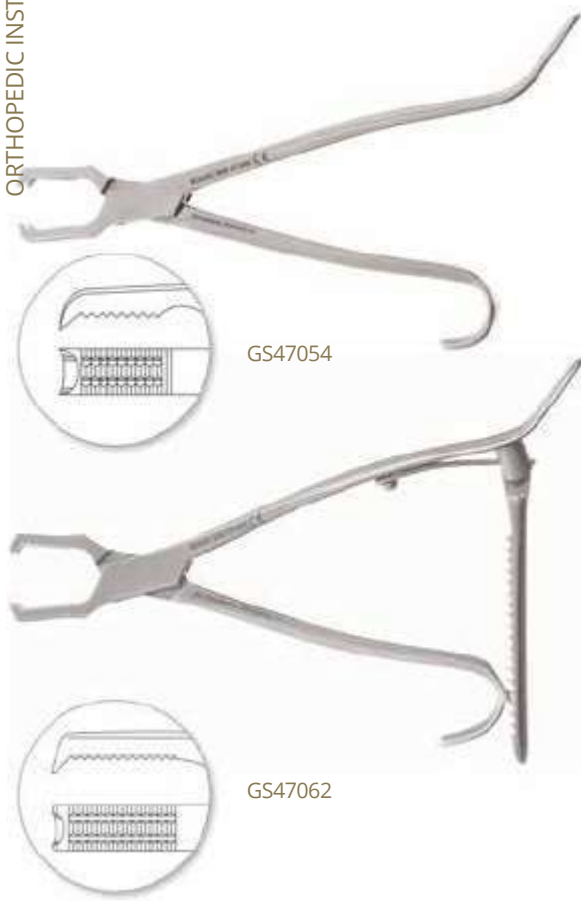

CATALOG #	Description
GS47054	Mini, 6-5/8" (17 cm), without ratchet
GS47056	9-1/2" (24 cm), without ratchet
GS47062	6-3/4" (17 cm), with ratchet
GS47064	9-1/2" (24 cm), with ratchet

LAMBOTTE BONE HOLDING FORCEPS



With swivel head, adjustable jaw.

CATALOG #	Description
GS47204	8-1/2" (22 cm)
GS47206	10-1/2" (27 cm)
GS47208	11-1/2" (29 cm)

BONE HOLDING INSTRUMENTS

Bone Holding Forceps

LANE BONE HOLDING FORCEPS



Particularly well suited for use during insertion of intermedullary nails.

CATALOG #	Description
GS47078	Light model, without ratchet, 13" (33 cm)
GS47080	Light model, with ratchet, 13" (33 cm)
GS47068	Standard model, without ratchet, 13" (33 cm)
GS47082	Standard model, with ratchet, 13" (33 cm)
GS47070	Without ratchet, 17" (43 cm)
GS47084	With ratchet, 17" (43 cm)

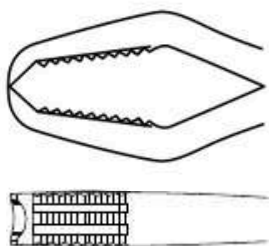

GS47078
GS47080

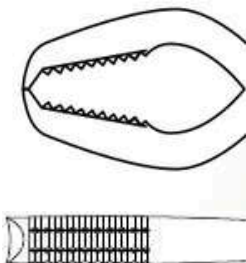

GS47068
GS47082_{Old}
SR 47068 CU,

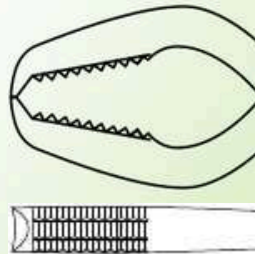

GS47070
SR 47070 CU,
GS47084_{Old}

BONE HOLDING INSTRUMENTS

Bone Holding Forceps

ORTHOPEDIC INSTRUMENTS

ULRICH SELF-RETAINING BONE HOLDING FORCEPS



GS47108

Straight, with speed lock.

CATALOG #	Description
GS47108	Mini, 7-1/4" (19 cm)
GS47110	8-1/2" (22 cm)
GS47112	7/8" (25 cm)
GS47114	10-1/4" (26 cm)



GS47108



GS47110

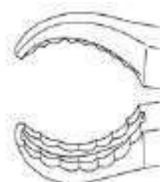

GS47112



GS47114

ULRICH SELF-RETAINING BONE HOLDING FORCEPS



GS47116

Angled, with speed lock.

CATALOG #	Description
GS47109	7-1/4" (19 cm)
GS47116	11" (28 cm)

BONE HOLDING INSTRUMENTS

Bone Holding Forceps

ULRICH SELF-RETAINING BONE HOLDING FORCEPS



GS47118

Angled, with speed lock and swivel jaw.

CATALOG #	Description
GS47118	11" (28 cm)

ANGLED BONE HOLDING FORCEPS



GS47212

With swivel head, adjustable jaw.

CATALOG #	Description
GS47212	8-1/2" (22 cm)

BONE HOLDING INSTRUMENTS

Bone Holding Forceps

ORTHOPEDIC INSTRUMENTS

VERBRUGGE SELF-CENTERING BONE HOLDING FORCEPS



Self centering, with speed lock.

CATALOG #	Description
GS47090	5-3/4" (15 cm)
GS47092	7-1/4" (19 cm)
GS47094	9-1/4" (24 cm)
GS47096	10" (26 cm)
GS47098	11-1/4" (29 cm)



VERBRUGGE BONE HOLDING FORCEPS



With short ratchet.

CATALOG #	Description
GS47120	6-7/8" (18 cm)

BONE HOLDING INSTRUMENTS

Bone Holding Forceps

VERBRUGGE BONE HOLDING FORCEPS



With long ratchet.

CATALOG #	Description
GS47122	10" (26 cm)
GS47124	10-1/2" (27 cm)
GS47126	11" (28 cm)

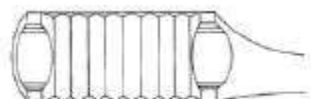
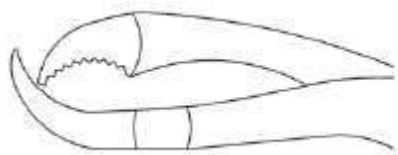

Bone Reduction Forceps

STAGBEETLE BONE REDUCTION FORCEPS



CATALOG #	Description
GS47119	Curved, pointed tips, 4-7/8" (13 cm)



BONE HOLDING INSTRUMENTS

Bone Reduction Forceps

ORTHOPEDIC INSTRUMENTS

MEILL BONE REDUCTION FORCEPS



GS47132

Catalog #
GS47132

Description
Curved, pointed tips, 6-3/4" (17 cm)

BONE REDUCTION FORCEPS

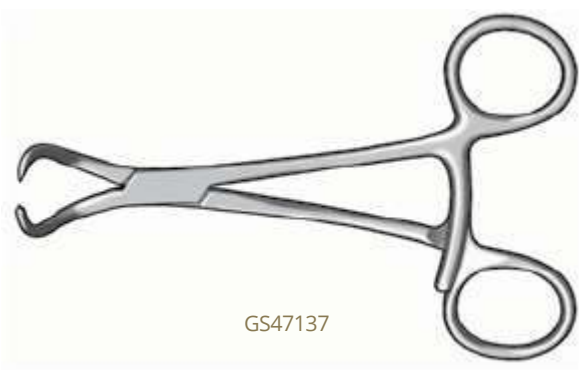

GS47137

Curved. One tip has a stepped point for a better hold on bone.

Catalog #
GS47137
GS47136

Description
5-1/4" (14 cm)
6-3/4" (17 cm)

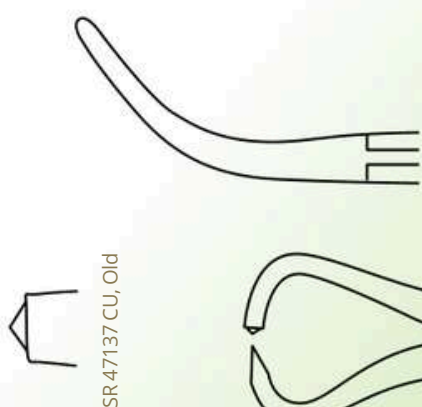

SR 47137 CU, Old

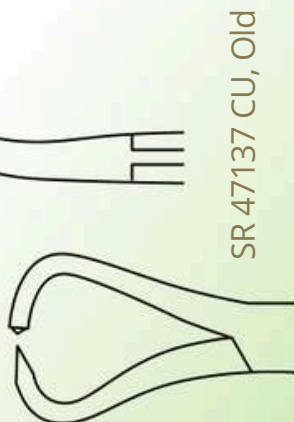

SR 47137 CU, Old

SR 47137 CU, Old

BONE HOLDING INSTRUMENTS

Bone Reduction Forceps

BONE REDUCTION FORCEPS



GS45300

Catalog #
GS45300

Description
Curved, pointed tips, 5" (13 cm)

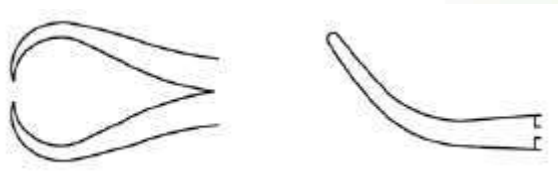

BONE REDUCTION FORCEPS



GS47134

With ratchet completely engaged, the jaw opening is 9 mm wide.

Catalog #
GS47134

Description
Ratchet length: 2" (5 cm)
Opens to 4" (10 cm)
8" (21 cm)

BONE HOLDING INSTRUMENTS

Bone Reduction Forceps

ORTHOPEDIC INSTRUMENTS

BONE REDUCTION FORCEPS

Curved and serrated with pointed tips.

Catalog #	Description
GS47133	Narrow, 5-1/4" (14 cm)
GS47135	Broad, 5-1/2" (14 cm)



BONE HOLDING INSTRUMENTS

Bone Reduction Forceps

BONE REDUCTION FORCEPS



Curved, with speed lock.

Catalog #	Description
GS47105	7" (18 cm)
GS47107	9-5/8" (25 cm)

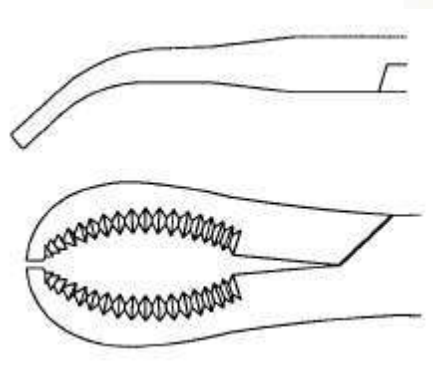

BONE REDUCTION FORCEPS



Catalog #	Description
GS47128	Small, curved, ratchet length 1-1/8" (28 mm), 5-1/2" (14 cm)

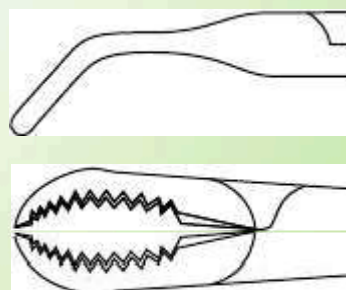

SR 47128 CU, Old

BONE HOLDING INSTRUMENTS

Bone Reduction Forceps

ORTHOPEDIC INSTRUMENTS

ANGLED PELVIC BONE REDUCTION FORCEPS

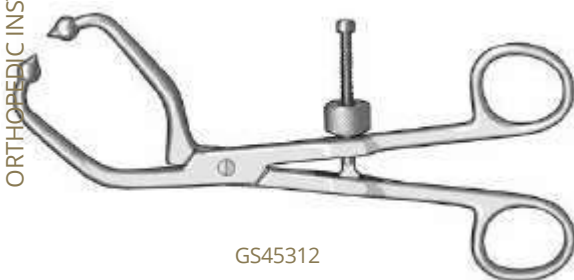

Short tips.

Catalog #	Description
GS45312	Short pointed-ball tips, 7-3/8" (19 cm)

ANGLED PELVIC BONE REDUCTION FORCEPS

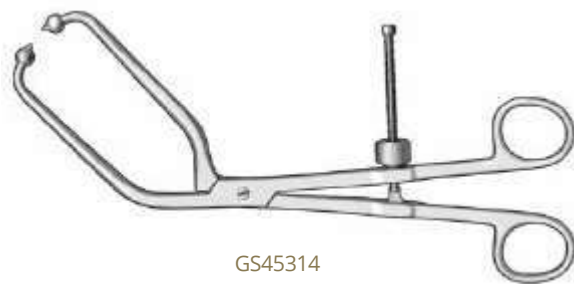

Long tips.

Catalog #	Description
GS45314	Long pointed-ball tips, 9-5/8" (25 cm)

ASYMETRIC PELVIC REDUCTION FORCEPS



Catalog #	Description
GS45310	Short pointed-ball tips, 16" (41 cm)

BONE HOLDING INSTRUMENTS

Bone Reduction Forceps

PELVIC REDUCTION FORCEPS



GS47100

Catalog #
GS47100

Description
With screws, 13-1/2" (35 cm)

PELVIC REDUCTION FORCEPS



GS47101

Catalog #
GS47101

Description
1 x 2 jaws, long pointed-ball tips, 16-1/8" (41 cm)

BONE HOLDING INSTRUMENTS

Bone Reduction Forceps

ORTHOPEDIC INSTRUMENTS

PELVIC REDUCTION FORCEPS



GS47102

Catalog #
GS47102Description
Angled tips, short pointed-ball tips, 10-1/8" (26 cm)

PELVIC REDUCTION FORCEPS

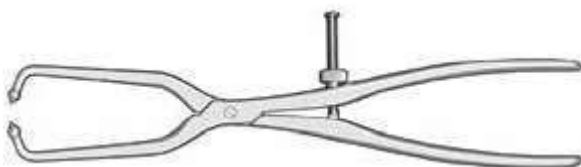

GS47103

Catalog #
GS47103Description
Pointed tips, long pointed-ball tips, 16-1/8" (41 cm)

BONE HOLDING INSTRUMENTS

Bone Clamps

BISHOP BONE CLAMP



GS47202

Catalog #	Description
GS47202	Adjustable jaw, 8-7/8" (22.5 cm)

LAMBERT-LOWMAN BONE CLAMPS



GS47167

2 x 2 jaws. Calibrated in inches to measure bone diameter.

Catalog #	Description
GS47167	7-1/4" (18.5 cm)
GS47168	8" (20.5 cm)



GS47167



GS47168

LOWMAN BONE CLAMPS



GS47154

1 x 2 jaws. Calibrated in inches to measure bone diameter.

Catalog #	Description
GS47140	4-3/4" (12 cm)
GS47154	5-5/8" (14.5 cm)
GS47156	6-3/4" (17 cm)



BONE HOLDING INSTRUMENTS

Bone Clamps

ORTHOPEDIC INSTRUMENTS

HOWMAN BONE CLAMPS

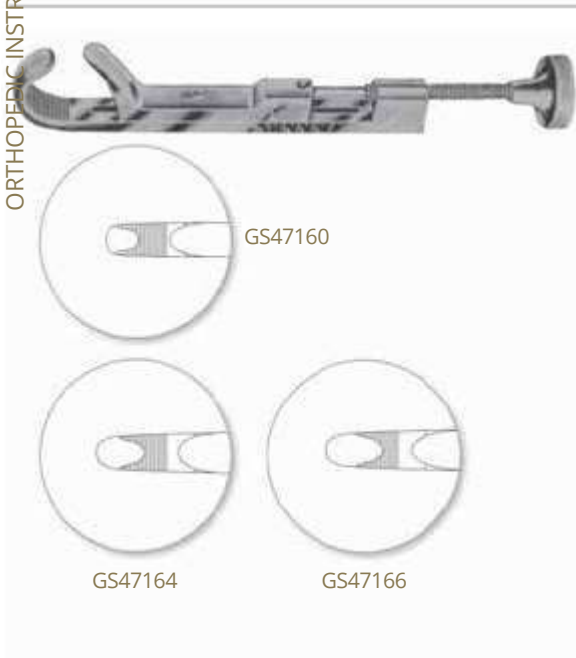

1 x 1 jaws. Calibrated in inches to measure bone diameter.

Catalog #	Description
GS47160	4-3/4" (12 cm)
GS47164	5-3/4" (14.5 cm)
GS47166	6-7/8" (17.5 cm)

ROSENBLOOM SESAMOID CLAMP



Catalog #	Description
GS69795	Slightly curved, 6-1/2" (16.5 cm)

BONE HOLDING INSTRUMENTS

Bone Clamps

VOGEN SESAMOID CLAMP



- Designed to grasp and hold a sesamoid while dissecting it free.
- The sesamoid is first exposed within the capsule, then the two-pronged tip is hooked beneath the sesamoid. The plunger is then seated in the bone to secure it for manipulation and dissection.

Catalog #	Description
GS69827	4" (10 cm) shaft

BONE HOOKS AND AWLS

Bone Hooks

ORTHOPEDIC INSTRUMENTS

SHARP HOOK



GS47880

To check fracture and remove ingrown tissue.

Catalog #	Description
GS47880	6" (15 cm)

BONE HOOKS



GS48343

GS48344

Sharp with grip handle, 9" (23 cm).

Catalog #	Description
GS48342	Small, 6 mm high x 10 mm deep
GS48343	Medium, 11 mm high x 18 mm deep
GS48344	Large, 12 mm high x 21 mm deep

VOLGSANN BONE HOOKS

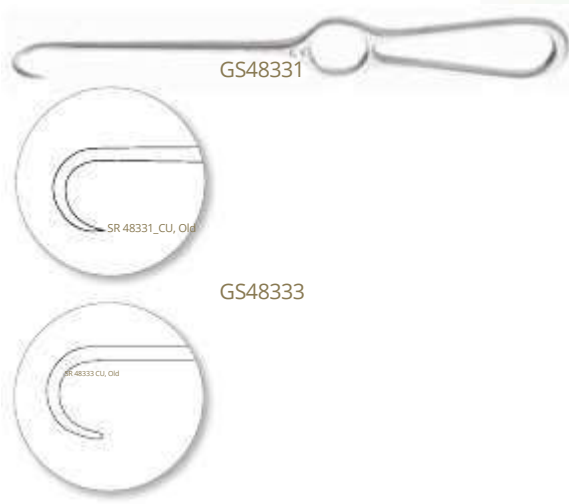

GS48331

SR 48331_CU, Old

GS48333

SR 48333_CU, Old

Catalog #	Description
GS48331	Sharp, 15 mm high x 20 mm deep, 9" (23 cm)
GS48335	Sharp, 15 mm high x 20 mm deep, 9-3/4" (25 cm)
GS48334	Sharp, 19 mm high x 27 mm deep, 8-5/8" (22 cm)
GS48333	Blunt, 15 mm high x 20 mm deep, 9" (23 cm)

BONE HOOKS AND AWLS

Bone Hooks

BONE HOOK



Large, for femurs. With T-handle.
 Description
 Catalog # GS48332
 Total length x 21 mm deep, 7-7/8" (20 cm)

Awls

BONE AWL



Catalog #	Description
GS48336	Square taper, 6-1/4" (16 cm)

KUNTSCHER DIAMOND POINTED AWL



Catalog #	Description
GS48303	With handle, 11-5/8" (29.5 cm)

BONE HOOKS AND AWLS

Awls

ORTHOPEDIC INSTRUMENTS

MERTHES BONE AWL



GS48337

Catalog #	Description
GS48337	8-1/4" (21 cm)

RUSH AWL AND REAMERS

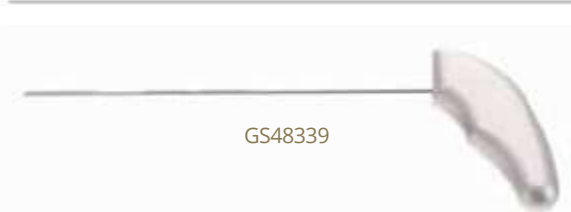

GS48339

For penetrating cortex of bone. Used as grooved director for insertion of pins.

Catalog #	Description
GS48338	0.1" (2.5 mm) diameter, working length 7-1/2" (19 cm), pointed, 9-7/8" (25 cm)
GS48339	0.1" (3 mm) diameter, working length 8-1/4" (21 cm), pointed, 10-5/8" (27 cm)
GS48340	0.2" (5 mm) diameter, working length 8-1/2" (21.5 cm), pointed, 10-7/8" (27.5 cm)
GS48341	0.25" (6 mm) diameter, working length 10-1/2" (26.5 cm), pointed, 12-3/4" (32.5 cm)

SHOULDER PENETRATING AWL



GS46916

Phenolic handle.

Catalog #	Description
GS46916	9-1/4"(23.5cm)

Autoclavable to 290°F (143°C)

BONE HOOKS AND AWLS

Awls

SHOULDER PERCUSSION AWLS

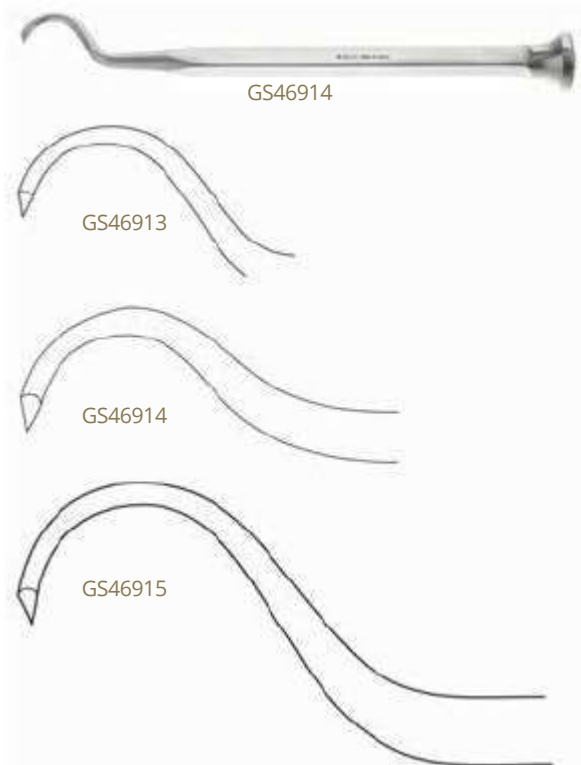

8-1/2" (21.5 cm).

Catalog #	Description
GS46913	Small
GS46914	Medium
GS46915	Large

BONE SAWS AND KNIVES

BONE SAWS AND KNIVES

GIGLI SAW BLADES



For cutting hard bone in difficult areas or situations.

Catalog #	Description
GS46612	9" (23 cm)
GS46613	12" (30.5 cm)
GS46609	16" (40.5 cm)
GS46614	20" (51 cm)
GS46615	30" (76 cm)
GS46616	Loop-style, 3-1/2" (9 cm) wide, one pair
GS46610	Loop-style with snap lock, 3-3/8" (8.5 cm) wide, one pair
GS46617	T-style, 2-1/2" wide, one pair

BONE SAWS AND KNIVES

ORTHOPEDIC INSTRUMENTS

MANEY GIGLI SAW GUIDE

Catalog #	Description
GS46620	Curved tip, straight shaft

CHARRIERE BONE SAWS



GS46683

Stainless steel frame, chrome blades.

Description	Catalog #
10-1/2" (26.5 cm) complete	GS46645
Chrome blade only for GS46645	GS46646
14" (35.5 cm) complete	GS46683
12 mm chrome blade only for GS46683	GS46684
14 mm chrome blade only for GS46683	GS46685

JOSEPH BONE SAWS



GS58096

7" (19 cm).

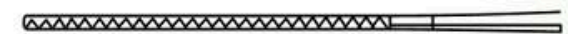

Description
Straight
Bayonet left
Bayonet right

Catalog #
GS58096
GS58097
GS58098



GS58097



GS58098

SR 58096 CU, Old

SR 58096 CU, Old

LANGENBECK METACARPAL SAW



GS46601

Description
9" (23 cm)

Catalog #
GS46601

GS58097
GS58096
GS58098

BONE SAWS AND KNIVES

LISTON AMPUTATING KNIVES



GS46598

Catalog #
GS46598
GS46600

Description
6-3/4" (17 cm) blade
8" (20.5 cm) blade

SATTERLEE BONE SAW



GS46643

Catalog #
GS46643

Description
Complete with ring handle, 11-1/2" (29 cm)

SATTERLEE SAW BLADES ONLY



GS46642

Catalog #
GS46642
GS46644

Description
Blade only for GS46643, 8-3/8" (21.5 cm)
Blade only for GS46643



GS46644

PERCY AMPUTATION SHIELD



GS46602

Catalog #
GS46602

Description
12" (30.5 cm)

BOUGIES & TRACHEOSTOMY TUBES

BOUGIES/DILATORS

Esophageal Bougies

MALONEY TAPERED TUNGSTEN-FILLED ESOPHAGEAL BOUGIES



507942

This tungsten-filled bougie provides a single style of dilator for treating cardiospasm, esophagitis, stenosis and other esophageal diseases. The small, flexible tip is easily introduced through the cricopharynx area, cardioesophageal junction or stenosis. Once the tip is through the involved area, the tapered end allows the single bougie to dilate this portion of the esophagus to its maximum limit. Overall length is approximately 29-1/2" (75 cm).

Catalog #	description	Catalog #	Description
507920	20 Fr.	507942	42 Fr.
507922	22 Fr.	507944	44 Fr.
507924	24 Fr.	507946	46 Fr.
507926	26 Fr.	507948	48 Fr.
507928	28 Fr.	507950	50 Fr.
507930	30 Fr.	507952	52 Fr.
507932	32 Fr.	507954	54 Fr.
507934	34 Fr.	507956	56 Fr.
507936	36 Fr.	507958	58 Fr.
507938	38 Fr.	507960	60 Fr.
507940	40 Fr.		

BOUGIE TRAY



508000

Stainless steel. Separately holds 12 individual bougies (Maloney or Hurst). Two tiers with upper tier have hinged handle, perforated trays and lid. Holding pins hold bougie cap to keep bougie straight and in corrugated channels.

Catalog #	Description
508000	31-5/8" x 11" (80.5 x 28 cm)

BOUGIES/DILATORS

Esophageal Dilators

JACKSON ESOPHAGEAL DILATORS



507820

The Jackson Esophageal Dilator has proved popular and effective among surgeons. Now available in a durable silicone material. This configuration is the safest of all forms of dilators because of the thin, flexible stem that enables accurate ocular guidance of the dilator into the lumen of the stricture. A small size (12 Fr.) is often useful to make sure of a lumen ahead at the cricopharyngeal and hiatal levels during esophagoscopy as well as in cases of stenosis. The steel stem also permits the use of the tiniest filiform sizes. Overall length ranges from 25" (63.5 cm) for the 8 - 12 Fr. to 26-1/2" (67.5 cm) for the 20 - 42 Fr.

Catalog	Description
507807	Dilator Set, includes one of each size listed,
507808	19 dilators, 8 Fr. - 42 Fr. 8Fr.
507809	9Fr.
507810	10 Fr.
507812	12 Fr.
507814	14 Fr.
507816	16 Fr.
507818	18 Fr.
507820	20 Fr.
507822	22 Fr.
507824	24 Fr.
507826	26 Fr.
507828	28 Fr.
507830	30 Fr.
507832	32 Fr.
507834	34 Fr.
507836	36 Fr.
507838	38 Fr.
507840	40 Fr.
507842	42 Fr.

TUCKER LUMEN FINDERS

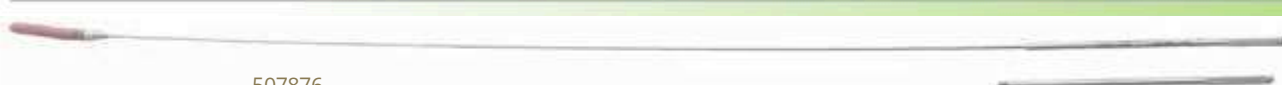

507876

Short, flexible, soft rubber tip affixed to 25-1/2" (65 cm) stem with removable handle extension. 30-3/4" (78 cm) overall length.

Catalog #	Description
507875	14 Fr.
507876	16 Fr.
507877	18 Fr.

BOUGIES/DILATORS

Laryngeal Dilators

JACKSON LARYNGEAL DILATORS



Rigid metallic dilators for direct laryngoscopic treatment of laryngeal stenosis. Eighteen graduated sizes for consecutive use, corresponding approximately to the French sizes listed below. Sizes 10-14 Fr. have a round end; sizes 16-44 Fr. have a triangular-shaped end. 11-3/4" (30 cm) length from tip to angle.

Catalog #	Description
507500	10 Fr.
507501	12 Fr.
507502	14 Fr.
507503	16 Fr.
507504	18 Fr.
507505	20 Fr.
507506	22 Fr.
507507	24 Fr.
507508	26 Fr.
507509	28 Fr.
507510	30 Fr.
507511	32 Fr.
507512	34 Fr.
507513	36 Fr.
507514	38 Fr.
507515	40 Fr.
507516	42 Fr.
507517	44 Fr.

JACKSON TRACHEOSTOMY TUBES

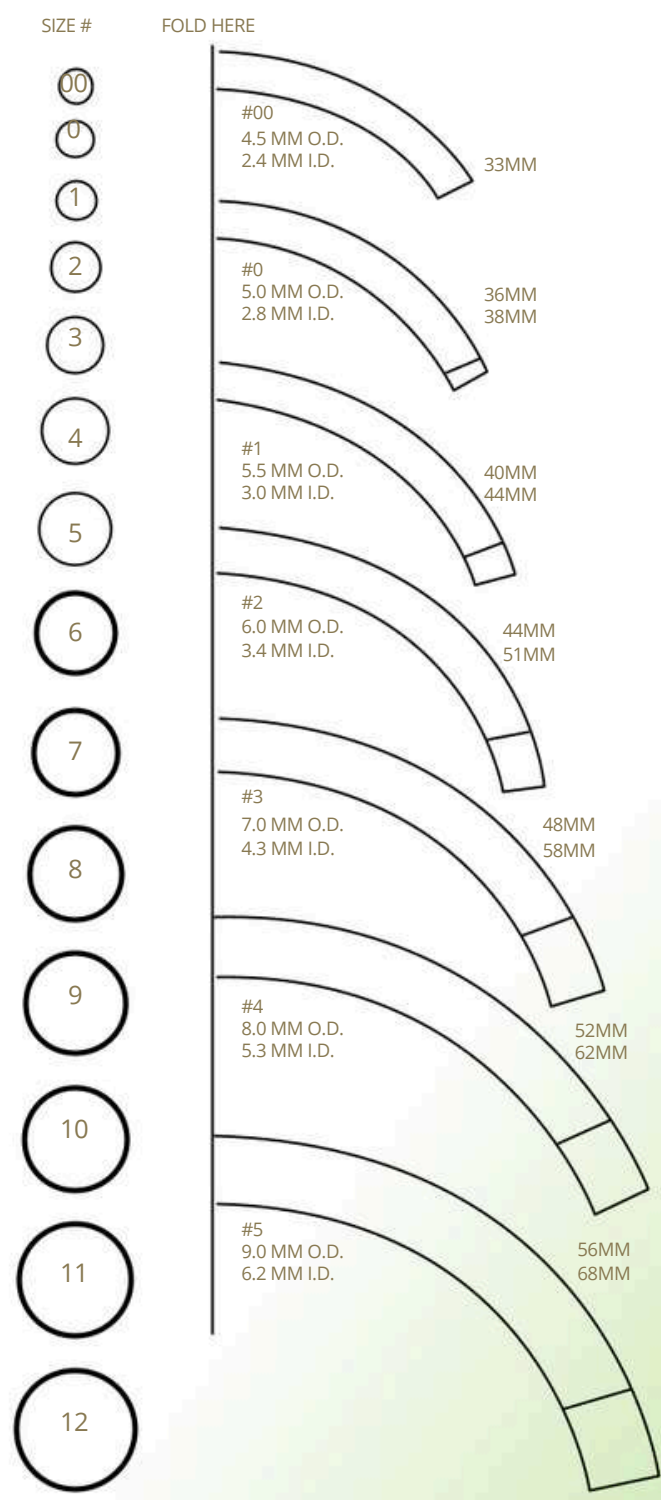

#6	10.0 MM O.D.	7.2 MM I.D.
#7	11.0 MM O.D.	8.3 MM I.D.
#8	12.0 MM O.D.	9.2 MM I.D.
#9	13.0 MM O.D.	9.9 MM I.D.
#10	14.0 MM O.D.	10.6 MM I.D.
#11	15.3 MM O.D.	12.3 MM I.D.
#12	16.3 MM O.D.	12.7 MM I.D.

Stainless steel. Sterling silver.

SIZE AND SHAPE SPECIFICATIONS

To measure a tube, fold page on line where indicated and lay the tube on the outline with plate over the page edge. Dimensions shown are tube diameter in mm and Fr. size, and the length in mm around the inside curve. The shorter of the length indicated (48 mm on #3) applies to Jackson Short Length Tubes. The longer size (58 mm on #3) applies to Jackson Regular Length Tubes. The shape diagrams are quite accurate and are shown to aid in ordering special length tubes as well as standard lengths.

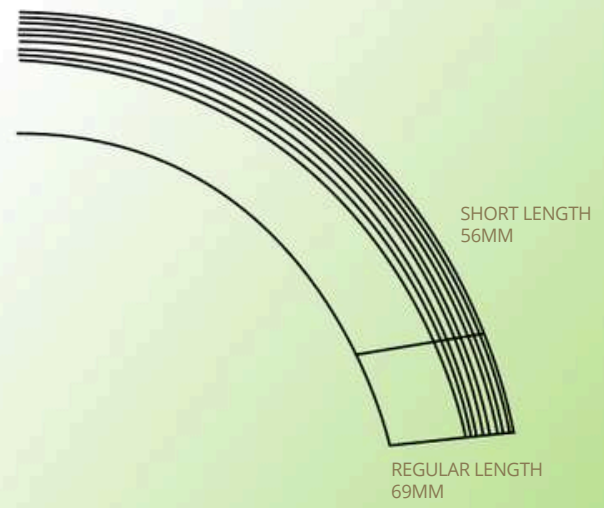

NOTE
 FIRST LINE ON LENGTH CURVE = SHORT
 FULL LENGTH CURVE = REGULAR
 16 MM PAST FULL LENGTH LINE = EXTRA-LONG

TRACHEOSTOMY TUBES

Jackson Improved Design

JACKSON IMPROVED TRACHEOSTOMY TUBES - REGULAR LENGTH



Stainless steel. The improved model with a rotating lock provides quick, easy removal of the inner tube. A set consists of an outer tube, inner tube and obturator.



518030

Catalog #	size	(MM) o.D.	(MM) i.D.	(MM) length
518010	e	5.5	3.0	44.0
518015	1	6.0	3.4	51.0
518020	2	7.0	4.3	58.0
518025	3	8.0	5.5	62.0
518029*	4	8.0	5.5	62.0
518030	4	9.0	6.2	68.0
518034*	5	9.0	6.2	68.0
518035	5	10.0	7.2	69.0
518039*	6	10.0	7.2	69.0
518040	6	11.0	8.1	69.0
518044*	7	11.0	8.1	69.0
518045	7	12.0	9.2	69.0
518049*	8	12.0	9.2	69.0
518050	8	13.0	9.9	69.0
518055	9	14.0	10.	69.0
	10		6	

* These Jackson Tubes are fenestrated to facilitate speech. The fenestration is located at a point measured from the neckplate equal to 1/3 of the length of the tube on both the inner and outer tubes.



* Fenestrated Jackson Tube

TRACHEOSTOMY TUBES

Jackson Improved Design

JACKSON EXTRA-LONG TRACHEOSTOMY TUBES WITH ROTATING LOCK



518904

Stainless steel. The Jackson Extra-Long Tracheostomy Tubes are 16 mm longer than standard Jackson tubes. They are made in sizes 5 through 9 only in stainless steel. Size and shape may be chosen using the Jackson Tracheostomy Tubes diagram located at the beginning of this section. The length of the outer arc is 16 mm longer than the regular length. A set consists of an outer tube, inner tube and obturator.

Catalog #	siz	(MM) o.D.	(MM) i.D.	(MM) length
518900	e	9.0	6.2	84.0
518902	5	10.0	7.2	85.0
518904	6	11.0	8.3	85.0
518906	7	12.0	9.2	85.0
518908	8	13.0	9.9	85.0
	9			

TRACHEOSTOMY TUBES

Jackson Improved Design

JACKSON IMPROVED TRACHEOSTOMY TUBES - SHORT LENGTH



518225

Stainless steel. These tubes follow the regular Jackson curve and supply the need for tubes of lengths between the regular Jackson and the short Luer Tube. A set consists of an outer tube, inner tube and obturator.

Catalog #	size	(MM) o.D.	(MM) i.D.	(MM) length
518215	3	7.0	4.3	48.0
518220	4	8.0	5.5	52.0
518225	5	9.0	6.2	56.0
518230	6	10.0	7.2	56.0
518235	7	11.0	8.1	56.0
518240	8	12.0	9.2	56.0
518245	9	13.0	9.9	56.0
518250	10	14.0	10.6	56.0

JACKSON IMPROVED TRACHEOSTOMY TUBES WITH 15 MM ADAPTER - REGULAR LENGTH



Stainless steel. For use with positive pressure and anesthesia units. Adapters are permanently attached and not available as parts. A set consists of an outer tube, inner tube and obturator.

Catalog #	size	(MM) o.D.	(MM) i.D.	(MM) length
518426	4	8.0	5.5	63.0
518431	5	9.0	6.2	69.0
518436	6	10.0	7.2	70.0
518441	7	11.0	8.1	70.0
518446	8	12.0	9.2	70.0
518456	10	14.0	10.6	70.0

TRACHEOSTOMY TUBES

Jackson Improved Design – Shikani Valve Compatible

JACKSON IMPROVED STYLE TRACHEA TUBES FOR USE WITH SHIKANI SPEAKING VALVE



Shikani French Speaking Valve shown attached to Jackson Trachea Tube.

Product codes with an “A” on the end are designed to accept the Shikani-French Speaking Valve. Complete tube consists of inner tube, outer tube and obturator (pictured: outer tube with inner tube insert, obturator). Valve sold separately.

Catalog#	size	(MM)o.D.	(MM)i.D.	(MM)length
518025A	4	8.0	5.5	62.0
518029A*	4	8.0	5.5	62.0
518030A	5	9.0	6.2	68.0
518034A*	5	9.0	6.2	68.0
518035A	6	10.0	7.2	69.0
518039A*	6	10.0	7.2	69.0
518040A	7	11.0	8.1	69.0

* These Jackson tubes are fenestrated to facilitate speech. The fenestration is located at a point measured from the neckplate equal to 1/3 of the length of the tube on both the inner and outer tubes.



* Fenestrated Jackson Tube

TRACHEOSTOMY TUBES

Jackson Improved Design – Shikani Valve Compatible

SHIKANI-FRENCH SPEAKING VALVE AND INNER TUBE COMBINATION



518027

Patients using standard Jackson Trachea Tubes can now realize the benefits provided by the Shikani-French Speaking Valve. By replacing the inner trachea tube with one of the tubes listed below, patients can attach the snap-on Shikani Valve. Each inner tube is provided with two speaking valves.

If You are Using this Standard Jackson Trachea Tube ...		non-Fenestrated Jackson Improved Inner Tube Only With 2 Shikani Valves				
518025	ORDER	518027	4	5.5	62.0	
518030	ORDER	518032	5	6.2	71.0	
518035	ORDER	518037	6	7.2	72.0	
518040	ORDER	518042	7	8.1	72.0	

SHIKANI-FRENCH TRACHEOSTOMY SPEAKING VALVE



518085

A lower airway resistance speaking valve, the Shikani-French Speaking Valve attaches to the standard 15 mm hubs found on plastic and metal tracheostomy tubes. Certain patients may benefit from this unique ball valve design which provides less resistance to airflow at very low flow rates when compared to the membrane valves used on other brands of tracheostomy speaking tubes. The Shikani-French Speaking Valve requires less effort to move air through the valve at low inspiration pressures. Competitive valves are normally in a closed position and require greater inspiratory pressures to initially open the valve and allow airflow. An additional advantage of the Shikani-French Speaking Valve is its low profile, which makes it easy to conceal under clothing.

Catalog #	Description
518085	Shikani-French Speaking Valve for use with Jackson Improved Stainless Steel Tracheostomy Tubes (package of 2)

TRACHEOSTOMY TUBES

Jackson Original Design

JACKSON ORIGINAL TRACHEOSTOMY TUBES - REGULAR LENGTH

Stainless steel. These tubes have the neck plate of the original Jackson design with a small swivel lock holding the inner tube in place. A set consists of an outer tube, inner tube and obturator.



Catalog #	size	(MM) o.D.	(MM) i.D.	(MM) length
518100	00	4.5	2.4	33.0
518115	2	6.0	3.4	51.0
518120	3	7.0	4.3	58.0
518125	4	8.0	5.5	62.0
518129*	4	8.0	5.5	62.0
518130	5	9.0	6.2	68.0
518134*	5	9.0	6.2	68.0
518135	6	10.0	7.2	69.0
518139*	6	10.0	7.2	69.0
518140	7	11.0	8.1	69.0
518144*	7	11.0	8.1	69.0
518145	8	12.0	9.2	69.0
518149*	8	12.0	9.2	69.0
518150	9	13.0	9.9	69.0
518155	10	14.0	10.6	69.0

* These Jackson tubes are fenestrated to facilitate speech. The fenestration is located at a point measured from the neckplate equal to 1/3 of the length of the tube on both the inner and outer tubes.

* Fenestrated Jackson Tube

JACKSON ORIGINAL TRACHEOSTOMY TUBES - SHORT LENGTH

These tubes follow the original Jackson curve and supply the need for tubes of lengths between regular Jackson and the short Luer tube. A set consists of an outer tube, inner tube and obturator.



Catalog #	size	(MM) o.D.	(MM) i.D.	(MM) length
518315	3	7.0	4.3	48.0
518320	4	8.0	5.5	52.0
518325	5	9.0	6.2	56.0
518330	6	10.0	7.2	56.0
518335	7	11.0	8.1	56.0
518340	8	12.0	9.2	56.0

TRACHEOSTOMY TUBES

Jackson Original Design

JACKSON ORIGINAL TRACHEOSTOMY TUBES WITH 15 MM ADAPTER - REGULAR LENGTH



Stainless steel. For use with positive pressure and anesthesia units. Adapters are permanently attached and not available as parts. A set consists of an outer tube, inner tube and obturator.

Catalog#	size	(MM)o.D.	(MM)i.D.	(MM)length
518521	3	7.0	4.3	58.0
518526	4	8.0	5.5	62.0
518531	5	9.0	6.2	68.0
518536	6	10.0	7.2	69.0
518541	7	11.0	8.1	69.0
518546	8	12.0	9.2	69.0
518556	10	14.0	10.6	69.0

JACKSON ORIGINAL TRACHEOSTOMY TUBES WITH 15 MM ADAPTER -SHORT LENGTH



Stainless steel. For use with positive pressure and anesthesia units. Adapters are permanently attached and not available as parts. A set consists of an outer tube, innertubeandobturator.

Catalog#	size	(MM)o.D.	(MM)i.D.	(MM)length
518720	4	8.0	5.5	52.0
518730	6	10.0	7.2	56.0

TRACHEOSTOMY TUBES

TuckerDesign

TUCKER TRACHEA TUBES AND VALVES



511734

Tucker Tracheostomy Tubes Sterling silver. Acutely curved to a full 90 degree arc.

The neckplate, with small swivel lock, is of a distinctive design for identification purposes. A set consists of an

outer tube, inner tube and obturator. Tucker-valved inner tubes (see below) are accessories.

Tucker Speaker Valve

The Tucker Valve is built into an inner tube and allows for normal speech without covering the tube with a finger. The valve opens on inhalation through the tube. On exhalation, the valve leaflet closes, forcing air up through the upper airway. Tucker-valved inner tubes are available for regular length Jackson and Tucker Tubes as a standard item in sizes 4 through 9 in Tucker Tubes, and 4 through 8 in Jackson Tubes. Other sizes and styles are made on special order. The Tucker Valve is for use with sterling silver tubes only. Tucker Valve Inner Tubes are not supplied as part of the regular trachea tube and must be ordered separately. An obturator is supplied with the inner and outer tube sets.



511735

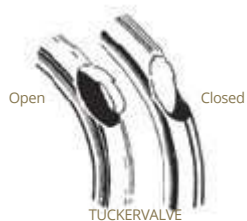

Catalog#	Description	(MM) o.D.	(MM) i.D.	(MM) length
511725	Size 4, inner and outer tubes, obturator	8.0	5.3	55.0
511729	Tucker valve inner tube to fit #4	-	5.3	58.0
511730	Tucker tube	9.0	6.1	60.0
511734	Size 5, inner and outer tubes, obturator	-	6.1	63.0
511735	Tucker valve inner tube to fit #5	-	6.1	63.0
511735	Size 6, inner and outer tubes, obturator	10.0	7.2	60.0
511739	Tucker valve inner tube to fit #6	-	7.2	63.0
511740	Size 7, inner and outer tubes, obturator	11.0	8.1	60.0
511744	Tucker Valve inner Tube to fit #7	-	8.1	63.0
511745	Size 8, inner and outer tubes, obturator	12.0	9.1	60.0
511749	Tucker Valve inner Tube to fit #8	-	9.1	63.0
511749	Tucker Tube	-	9.1	63.0

TRACHEOSTOMY TUBES

Mayo Design

MAYO CLINIC TUBE



The Mayo Clinic Tube has a Holinger-Style Neckplate on a Jackson Stainless Steel tube.

Catalog #	size	(MM) o.D.	(MM) i.D.	(MM) length
511930	5	9.0	6.2	56.0
511940	6	10.0	7.2	56.0
511945	6	10.0	7.2	69.0
511955	7	11.0	8.1	69.0

Holinger Design

HOLINGER TRACHEOSTOMY TUBE



Sterling silver. The tube is attached to the plate-shield at an acute downward angle of 65 degrees rather than the usual 90 degree tube-to-plate alignment. The dimensions of the neckplate are in proportion to the tube size. Corners are rounded; there are no rough projections. Funnel-shaped opening provides for easy insertion of aspirating catheters. A set consists of an outer tube, inner tube and obturator. Available in size 6. Additional sizes available by special order.

Catalog #	(MM) o.D.	(MM) i.D.	(MM) length
512205	10.0	7.1	63.0

TRACHEOSTOMY TUBES

Luer Design

LUER TRACHEOSTOMY TUBE



Sterling silver. This short model tube is more acutely curved than Jackson types and has the original style neckplate. A set consists of an outer tube, inner tube and obturator. All are 42 mm long. Available in size 6. Additional sizes available by special order.

Catalog #	size	(MM) o.D.	(MM) i.D.	(MM) length
511635	6	10.0	7.1	42.0



511635

TRACHEOSTOMY TUBES

Air-Lon Design

®

AIR-LON® TRACHEA TUBE INHALATION SETS



515116

Air-Lon® Tracheal Inhalation Cannula Set, nylon, includes an outer cannula, obturator and inner cannula with a permanently attached 15 mm male adapter; sizes 4, 6, 7 and 8.

Catalog #	size	(MM) o.D.		(MM) inner	(MM) oUter
			(MM) i.D.	length	length
515106	4	8.0	5.0	62.0	76.0
515116	6	10.0	8.0	72.0	89.0
515121	7	11.0	9.0	76.0	95.0
515126	8	12.0	10.0	81.0	102.0

AIR-LON® TRACHEA TUBES



515120

Air-Lon® Trachea Tube, nylon, 90 degree arc; sizes 4 through 8.

Catalog #	size	(MM) o.D.		(MM) inner	(MM) oUter
			(MM) i.D.	length	length
515105	4	8.0	5.0	62.0	76.0
515110	5	9.4	7.0	65.0	83.0
515115	6	10.0	8.0	72.0	89.0
515120	7	11.0	9.0	76.0	95.0
515125	8	12.0	10.0	81.0	102.0

TRACHEOSTOMY TUBES

Laryngectomy Style Tubes

HOLINGER LARYNGECTOMY TUBES



Sterling silver. The cannula is attached to the plate at an acute downward angle of approximately 65 degrees.

The shield is shaped carefully to be flat and with no projections to catch gauze. Rotating lock mechanism. A set consists of outer tube, inner tube and obturator.

Catalog #	size	(MM) o.D.	(MM) i.D.	(MM) length
516270	7	12.0	9.0	50.0
516275	8	13.6	10.0	50.0
516280	9	14.0	10.6	50.0
516285	10	14.3	11.2	50.0

JACKSON LARYNGECTOMY TUBES



Stainless steel. These tubes have the standard Jackson curve with an improved neckplate. The rotating lock provides a protrusion-free surface for ease in wiping. Flattened shape allows neckplate to be hidden more easily beneath clothing. A set consists of outer tube, inner tube and obturator.

Catalog #	size	(MM) o.D.	(MM) i.D.	(MM) length
519000	6	10.0	7.2	55.0
519005	7	12.0	9.1	55.0
519010	8	13.6	10.0	55.0
519015	9	14.0	10.7	5.0
519020	10	14.5	11.1	55.0
519025	11	15.4	12.3	55.0
519030	12	16.4	12.7	55.0

TRACHEOSTOMY TUBES

Laryngectomy Style Tubes

MARTIN LARYNGECTOMY TUBES - REGULAR AND EXTENSION



516390

Sterling silver. The Martin Cannula is short length and is attached to the neckplate shield at an acute downward angle. These tubes are available as a regular set consisting of outer tube, inner tube, and obturator. Martin Tubes are also available with the dressing extension cannula, a 2.5 mm extension projecting proximally to extend out past thick, bulky dressings. The Martin Extension set consists of outer tube, standard inner tube, special extension inner tube and obturator.

Regular Sets

CoMplete tUBe	size	(MM) o.D.	(MM) i.D.	(MM) length
516390	10	14.0	10.6	43.0
516400	12	16.3	12.7	43.0

Extension Set

CoMplete tUBe	size	(MM) o.D.	(MM) i.D.	(MM) length
516430	6	16.3	12.7	43.0

TRACHEOSTOMY TUBES

Trach Buttons

NORRIS TRACHEOSTOMY BUTTONS



Useful in preventing contracture of the tracheal stoma.
Machined of white PTFE.

Catalog #	(MM) i.D.	(MM) a	(MM) B
512780	8.3	19.0	11.0
512782	9.1	19.0	12.0
512784	10.3	19.0	13.0

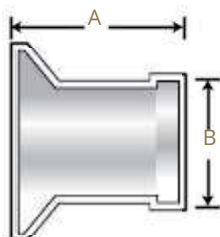

TRACHEOSTOMY TUBES

Tracheal Dilators

JACKSON-TROUSSEAU TRACHEAL DILATORS

2-blade design.

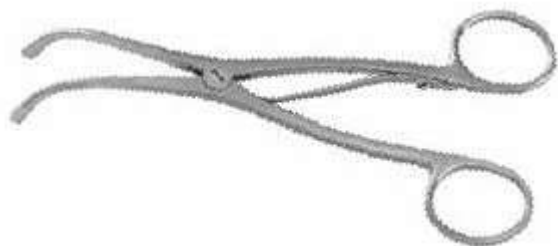

514376

Catalog #	Description
514375	Infant, tip width 4.0 mm, tip length 25.5 mm, 5-1/2" (14 cm)
514376	Child, tip width 4.4 mm, tip length 17.5 mm, 5-1/2" (14 cm)
514377	Adult, tip width 5.2 mm, tip length 25.5 mm, 5-1/2" (14 cm)

LABORDE TRACHEAL DILATOR

3-blade design.



514380

Catalog #	Description
514380	5-1/2" (14 cm)

TRACHEOSTOMY TUBES

Miscellaneous

NEWS TRACHEA RETRACTOR



Catalog #
070114

Description
Sharp, 10 mm hook, 5-7/8" (15 cm)

LUKENS THYMUS RETRACTOR



Catalog #
514412

Description
Blade 3/8" wide x 1/4" deep (9 x 6 mm),
Overall length 6-7/8" (17.5 cm)

JACKSON TRACHEAL TENACULUM



Catalog #
514413

Description
Hook depth 1/4" (0.5 cm), 5-1/4" (13.5 cm)

JACKSON TRACHEAL RETRACTOR, DOUBLE-ENDED



.Pattern, satin finish.

Catalog #
514414

Description
Double-pronged, 1" wide x 1/4" deep
(2.5 cm x 0.5 cm) blade, 6-7/8" (17.5 cm)

TRACHEOSTOMY TUBES

Miscellaneous

JACKSON TRACHEA RETRACTOR



Weck® Pattern, bright finish.

Catalog #	Description
070116	2 prongs, 7" (18 cm)

BERNAY FINGER RAKE TRACHEAL RETRACTORS



514433



514438

Catalog #	Description
514430	1 prong, sharp, 6-5/8" (17 cm)
514431	2 prongs, sharp, 6-5/8" (17 cm)
514433	3 prongs, sharp, 6-5/8" (17 cm)
514435	1 prong, blunt, 6-5/8" (17 cm)
514436	2 prongs, blunt, 6-5/8" (17 cm)
514437	3 prongs, blunt, 6-5/8" (17 cm)
514438	4 prongs, blunt, 6-5/8" (17 cm)

TRACHEOSTOMY TUBES

Cleaning Brushes

HOLMAN TRACHEA TUBE BRUSHES



508545

For loosening hardened secretions not freed by washing.

Catalog #	Description
508545	Set of three: small, medium, large
508546	Trachea tube brush, small 6.5 mm x 14.5 cm
508547	Trachea tube brush, medium 8 mm x 15 cm
508548	Trachea tube brush, large 9 mm x 20 cm

HOLMAN SCOPE BRUSHES - FOR BRONCHOSCOPES AND ESOPHAGOSCOPES

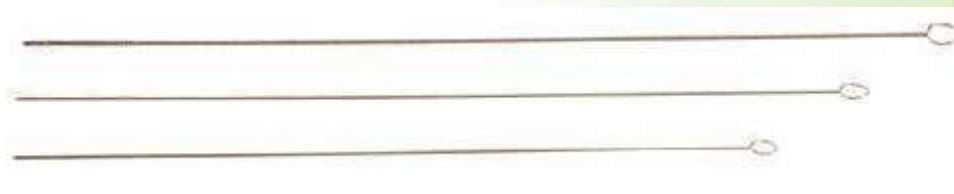

508540

For loosening hardened secretions not freed by washing.

Catalog #	Description
508540	Set of three: small, medium, large
508541	Brush for large scopes, 15 mm x 62 cm
508542	Brush for medium scopes, 11 mm x 56 cm
508543	Brush for small scopes, 9 mm x 49 cm
508544	Special extra small brush for infant scopes, 6mmx46cm

BRONCHOSCOPES

BRONCHOSCOPES



Bronchoscopes are designed in conjunction with Dr. Paul Holinger and Dr. C.L. Jackson for ease in examination and performance of surgical procedures in the lung and bronchi. These instruments use fiberoptics

to provide cool, constant illumination and nearly full lumen view. Each type of scope is designed with channels to ventilate the patient during the procedure.

. BRONCHOSCOPE AND LASER BRONCHOSCOPE PATIENT SIZE LISTING

Catalog #	proDUct naMe
NEONATE/INFANT BRONCHOSCOPES	
522575	Holinger
522576	Holinger
522550	. Improved Holinger
522552	. Improved Holinger
CHILD/PEDIATRIC BRONCHOSCOPES	
522554	. Improved Holinger
522556	. Improved Holinger
522576	Holinger
522577	Holinger
523578	Holinger

Catalog #	proDUct naMe
ADOLESCENT BRONCHOSCOPES	
522579	Holinger
522580	Holinger
522581	Holinger
522582	Holinger
522583	Holinger
ADOLESCENT LASER BRONCHOSCOPES	
523120P	.CO2
523130P	.CO2
523176	.YAG
522584	Holinger
522585	Holinger
522586	Holinger
522587	Holinger
ADULT LASER BRONCHOSCOPES	
523140P	.CO2
523150P	.CO2
523160P	.CO2

BRONCHOSCOPES

Holinger Design

HOLINGER VENTILATING FIBEROPTIC BRONCHOSCOPE

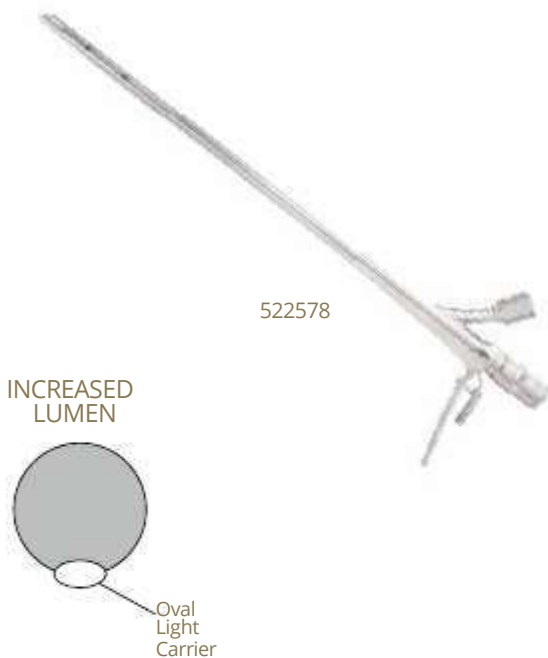

Designed by Dr. Paul Holinger, these fiberoptic bronchoscopes provide a nearly full view of the lumen with constant, cool illumination. Special features include:

- 15 mm sidearm for direct attachment of ventilation and anesthesia apparatus.
- Large fiber bundle for increased distal illumination.
- Oval fiber optic light carrier, which allows more viewing and instrumentation room in main tube.
- 15 mm diameter proximal end for attachment of accessories (window plug, Sanders Venturi, etc.).
- Smooth distal tip.
- Shortened proximal flare.
- Each Holinger Bronchoscope is supplied with one light carrier and one window plug (522595).
- Blue fiber optic cable sold separately (see pg. 467).

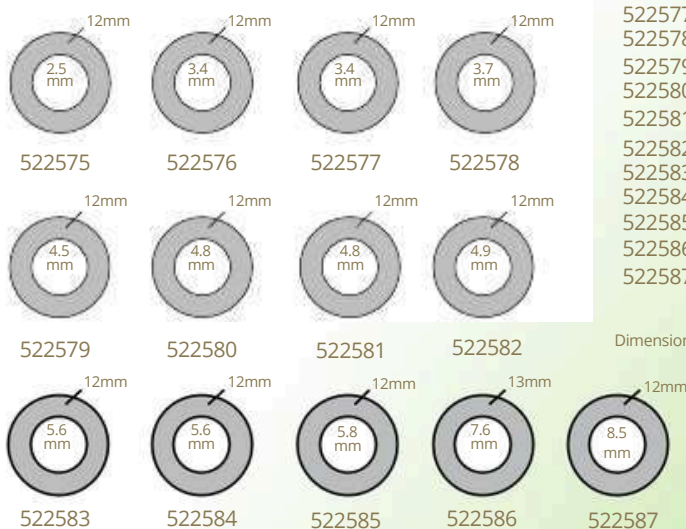

Catalog #	Scope size	overall length	Min i.D.	nominal proximal i.D.	Max o.D.	replace Carrier
522575	3x20	203mm	2.5mm	12.0mm	9.4mm	527500
522576	3.5 x 25	254mm	3.4mm	12.0mm	12.0 mm	527505
522577	3.5 x 30	305mm	3.4mm	12.0mm	12.0 mm	527510
522578	4x30	305mm	3.7mm	12.0mm	12.0 mm	527510
522579	5x30	305mm	4.5mm	12.0mm	12.5 mm	527510
522580	5x35	350mm	4.8mm	12.0mm	12.5 mm	527515
522581	5x40	400mm	4.8mm	12.0mm	12.5 mm	527520
522582	5x45	451mm	4.9mm	12.0mm	12.0 mm	527525
522583	6x35	350mm	5.6mm	12.0mm	12.0 mm	527555
522584	6x40	400mm	5.6mm	12.0mm	13.0 mm	527560
522585	7x40	400mm	5.8mm	12.0mm	15.3 mm	527560
522586	8x40	400mm	7.6mm	13.0mm	15.4 mm	527580
522587	9x40	400mm	8.5mm	12.0mm	16.4 mm	527580

Dimensions without window plug.

Drawings illustrate Nominal Proximal Internal Dimensions and Minimum Internal Diameter (I.D.), NOT TO SCALE.

BRONCHOSCOPES

Holinger Pediatric Design

IMPROVED HOLINGER VENTILATING FIBEROPTIC BRONCHOSCOPES



- 524022 Telescope 2.7 mm, 0°
- 524036 Telescope Guide 2.7 mm
- 522552 Improved Holinger
- 505670 Bronchoscope 3.5 x 20
Flexible 1 mm Alligator Forceps

Our most popular bronchoscope, the Holinger, has been modified for pediatric foreign body removal and features the following:

- Small distal tip. The original Holinger tip has been cut down to correspond with tube size, while still retaining smoothness.
- Built-in instrument channel for introduction of flexible forceps or disposable suction.
- Full lumen view. The oval fiberoptic light carrier has been raised slightly to provide a full lumen and give more room for instrumentation and a larger viewing area.
- 15 mm sidearm attachment allows direct attachment of ventilation and anesthesia apparatus.

Each Improved Holinger Bronchoscope is supplied with one light carrier, one window plug (522595) and instrument guide rubber cap. Blue fiber optic cable sold separately (see pg. 467).

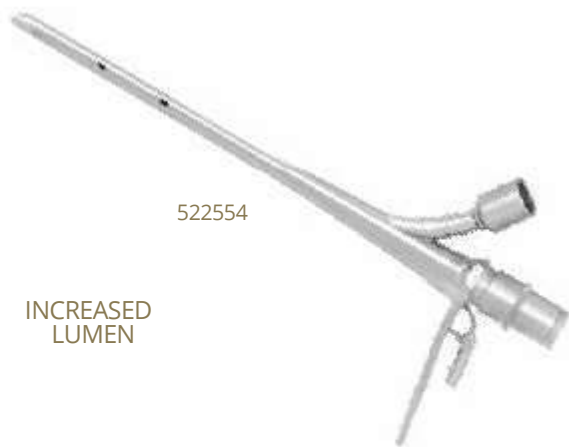

522554

INCREASED LUMEN

Catalog #	scope size	overall length	Min i.D.	nominal proximal i.D.	Max o.D.	replace Carrier
522550	3x20	203mm	2.9mm	12.0mm	9.0mm	527500
522552	3.5 x 20	203mm	3.5mm	12.0mm	12.0 mm	527500
522554	4x20	203mm	3.9mm	12.0mm	12.0 mm	527500
522556	4x25	254mm	3.9mm	12.0mm	11.0 mm	527505

Dimensions without window plug.

NOTE: The light carrier can be removed from the Improved Holinger Bronchoscope and forceps introduced through the light carrier channel with the 2.7 mm telescope in place (telescope may have to be partially withdrawn in 522550 and 522552 scopes).

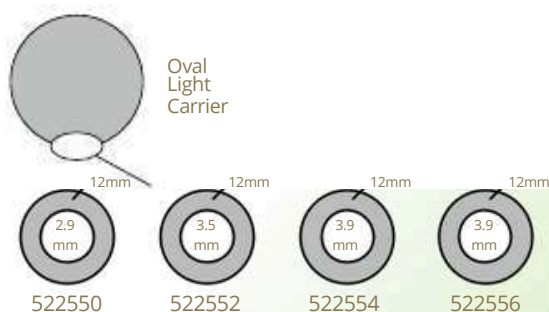

Drawings illustrate Nominal Proximal Internal Dimensions and Minimum Internal Diameter (I.D.), NOT TO SCALE.

BRONCHOSCOPES

Laser Bronchoscopes BRONCHOSCOPE SYSTEM

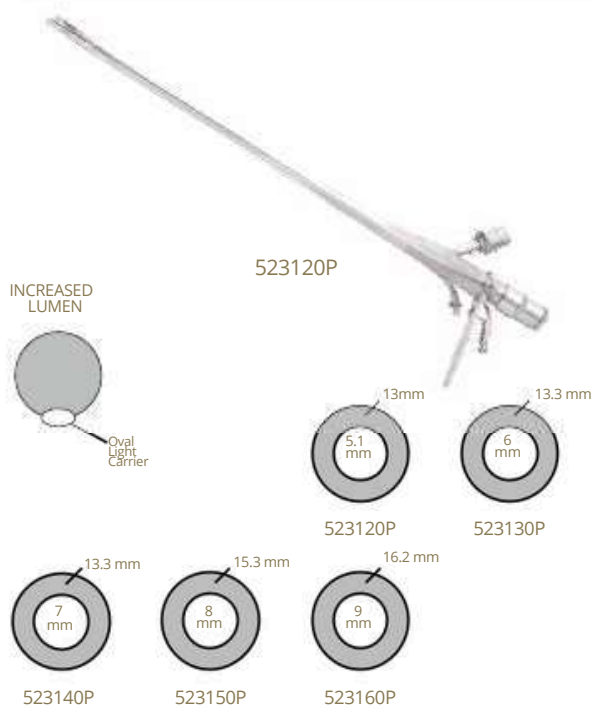

Drawings illustrate Nominal Proximal Internal Dimensions and Minimum Internal Diameter (I.D.), NOT TO SCALE.

- Holinger-type Bronchoscope with window plug.
- Standard 15mm anesthesia ventilating arm.
- Dedicated, distally-delivered YAG or suction channel.
- Dedicated, distally-opened smoke evacuation channel.
- Enlarged, oval fiberoptic, distal light carrier. One supplied with each scope.
- Five sizes of CO₂ bronchoscopes available.
- Can be used with CO₂ laser.
- Side ports can be used for flexible instrumentation.
- Blue fiberoptic cables sold separately (see pg. 467).

Catalog #	sScope size	overall length	Min i.D.	noMinal proximal i.D.	Max o.D.	replaCe Carrier
523120P	5.0x30	300mm	5.1mm	13.0mm	13.0mm	527550
523130P	6.0x35	350mm	6.0mm	13.3mm	13.3mm	523131
523140P	7.0x40	400mm	7.0mm	13.3mm	13.3mm	527580
523150P	8.0x40	400mm	8.0mm	15.3mm	15.3mm	527580
523160P	9.0x40	400mm	9.0mm	16.2mm	16.2mm	527580
524042	Replaceable rubber cap for Forceps/Suction Channel					

MOISTURE BARRIER FOR CO₂ COUPLER-MANIPULATOR



523210P

Catalog #	Description
523210P	To be used with the . CO ₂ Coupler-Manipulator 523200P

BRONCHOSCOPES

Bronchoscope Accessories

BRONCHOSCOPE ADAPTER



522590

Converts older Jackson and Holinger Bronchoscopes with 11 mm oxygen connector to standard 15 mm anesthesia and positive pressure connector.

Catalog #	Description
522590	Bronchoscope Ventilating Adapter, 3/4" (2 cm)

FLUVOG SLIDE ATTACHMENT FOR . BRONCHOSCOPES



502540

For use on bronchoscopes with the 15 mm proximal extension. Provides "closed system" bronchoscopes with the use of instrumentation.

Catalog #	Description
502540	Tapered fit for easy attachment or removal

BRONCHOSCOPE WINDOW PLUG REPLACEMENT LENS



522596

Catalog #	Description
522596	Replacement kit for Bronchoscope window plug, consists of lens and two Teflon seals

WINDOW PLUG



522595

Fits 15 mm proximal extension of Holinger and Jackson Bronchoscopes and Esophagoscopes. Provides a "closed system" for anesthesia in bronchoscopy or inflation during esophagoscopy.

Catalog #	Description
522595	Window plug, 1-1/8" (3 cm)

BRONCHOSCOPES

Cleaning Brushes

HOLMAN SCOPE BRUSHES

For loosening hardened secretions not freed by washing.

Catalog #	Description
508540	Set of three: small, medium, large
508541	Brush for large scopes, 15 mm x 62 cm
508542	Brush for medium scopes, 11 mm x 56 cm
508543	Brush for small scopes, 9 mm x 49 cm
508544	Special extra-small brush for infant scopes, 6mmx46cm

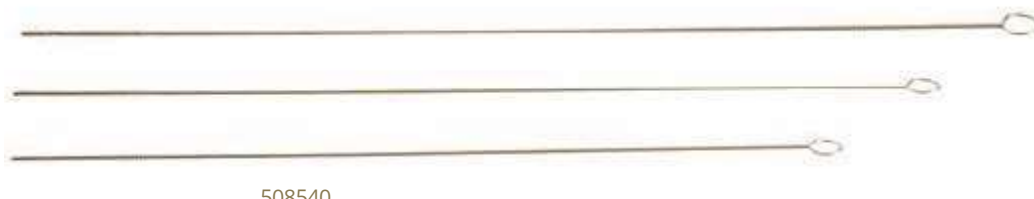

508540

CARTILAGE AND TENDON INSTRUMENTS

CARTILAGE AND TENDON INSTRUMENTS

Clamps and Forceps

ORTHOPEDIC INSTRUMENTS

MARTIN CARTILAGE CLAMPS



Deep teeth.

Catalog #	Description
GS46802	7-3/8" (18.5 cm)
GS46814	8-1/8" (20.5 cm)

WALTON CARTILAGE CLAMP



Catalog #	Description
GS46818	Slightly curved, 8-1/2" (21.5 cm)

CARTILAGE AND TENDON INSTRUMENTS

Clamps and Forceps

DINGMAN FORCEPS



Catalog #
GS46804

Description
Angular, 2 x 2 sharp teeth, serrated jaws,
7-1/2" (19 cm)

MENISCUS CLAMP



Catalog #
GS46750

Description
Curved shaft, 7-1/8" (18 cm)

CARTILAGE AND TENDON INSTRUMENTS

Clamps and Forceps

MENISCUS CLAMPS

ORTHOPEDIC INSTRUMENTS



Serrated, 5-3/8" (13.5 cm).

Catalog #	Description
GS46744	Straight
GS46746	Angled 20 degrees



PRESTON LIGAMENTUM FLAVUM FORCEPS (MENISCUS)



For grasping tags of the meniscus.

Catalog #	Description
GS46748	Serrated jaw with 1 x 2 tip, 7-1/4" (19 cm)

HOEN ALLIGATOR FORCEPS



For retrieving tendons or foreign bodies.

Catalog #	Description
GS55170	Serrated jaw with 1 x 2 tip, 5-7/8" (15 cm) shaft

CARTILAGE AND TENDON INSTRUMENTS

Clamps and Forceps

KLEINERT-KUTZ TENDON RETRIEVERS

Serrated with sharp teeth, 8" (20.5 cm).



Catalog #	Description
GS46735	Flexible shaft
GS46739	Rigid shaft

CARROLL TENDON RETRIEVER



Catalog #	Description
065325	Curved shaft, 6" (15 cm)

CARTILAGE AND TENDON INSTRUMENTS

Clamps and Forceps

ORTHOPEDIC INSTRUMENTS

STARR BRAND TENDON PULLING FORCEPS



Angular shaft.

Catalog #	Description
GS46736	6" (15 cm)
GS46737	7-1/2" (19 cm)
GS46738	9-1/2" (24 cm)

Cartilage Knives

DOWNING CARTILAGE KNIFE



Catalog #	Description
GS46772	Curved blade, concave edge. With guards, 10" (25.5 cm)

SMILLIE KNIVES

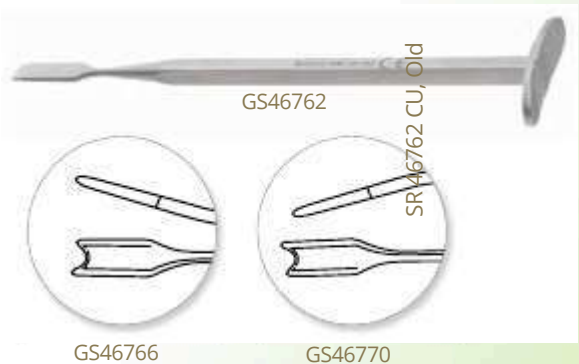

Also known as a meniscus knife. Useful for fasciotomies, 6-1/4" (16 cm).

Catalog #	Description
GS46762	Straight, chisel type
GS46766	Curved left
GS46770	Curved right

SR 46762 CU, Old

CARTILAGE AND TENDON INSTRUMENTS

Cartilage Scissors

MARTIN CARTILAGE SCISSORS



Catalog #
790320
GS46828

Description
Curved, two serrated blades, 8" (20.5 cm)
Two serrated blades, 8" (20.5 cm)

MUELLER CAPSULE SCISSORS



Catalog #
GS46821

Description
Angled, 9-1/2" (24 cm)

CARTILAGE AND TENDON INSTRUMENTS

Tendon Strippers

ORTHOPEDIC INSTRUMENTS

WUNNELL TENDON STRIPPERS



6" (15 cm).

GS46732

Catalog #	Description
GS46730	3mm
GS46731	4mm
GS46732	5mm



GS46730

GS46730



GS46731

-31



GS46732

-32



GS46733

-33



GS46734

-34

Note: gaps in circles are accurate.

Note: gaps in circles are accurate.

SR 46730 CU, Old

CHISELS AND GOUGES

CHISELS AND GOUGES

Chisels

ORTHOPEDIC INSTRUMENTS

ALEXANDER CHISELS

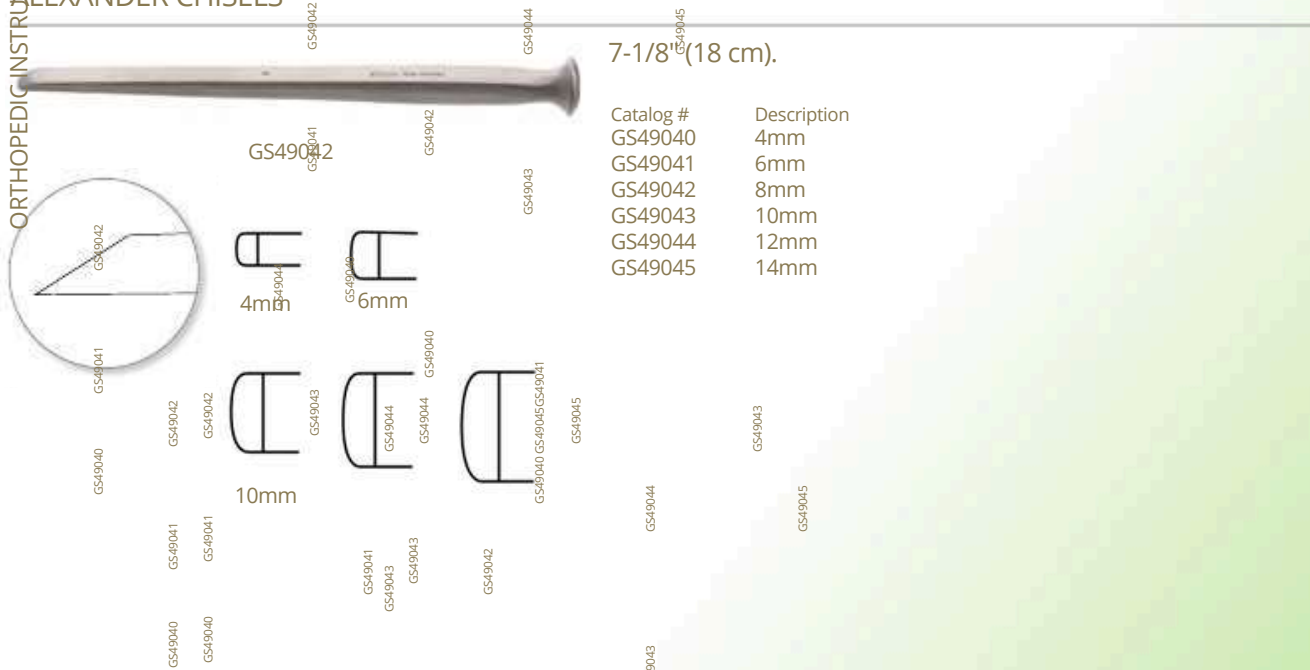

7-1/8" (18 cm).

Catalog #	Description
GS49040	4mm
GS49041	6mm
GS49042	8mm
GS49043	10mm
GS49044	12mm
GS49045	14mm

ARMY PATTERN CHISELS



SR 49040 CU, Old
7-1/8" (18 cm).

Catalog #	Description
GS46289	6mm
GS46290	12mm
GS46291	18mm

CHISELS AND GOUGES

Chisels

HIBBS CHISELS

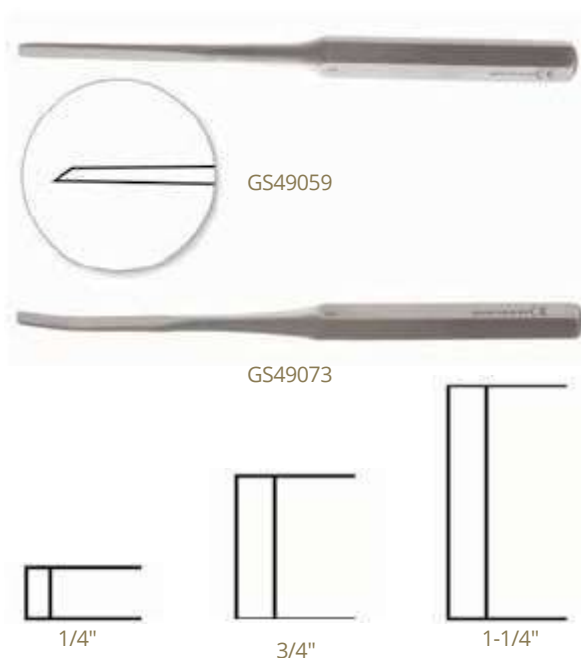

9" (23 cm).

Catalog #	tip	tip Width
GS49059	Straight	1/4"
GS49060	Straight	3/8"
GS49061	Straight	1/2"
GS49062	Straight	5/8"
GS49063	Straight	3/4"
GS49064	Straight	7/8"
GS49065	Straight	1"
GS49066	Straight	1-1/8"
GS49067	Straight	1-1/4"
GS49068	Straight	1-1/2"
GS49073	Curved	1/4"
GS49074	Curved	3/8"
GS49075	Curved	1/2"
GS49076	Curved	5/8"
GS49077	Curved	3/4"
GS49078	Curved	7/8"
GS49079	Curved	1"
GS49080	Curved	1-1/8"
GS49081	Curved	1-1/4"
GS49082	Curved	1-1/2"

HOKE CHISELS

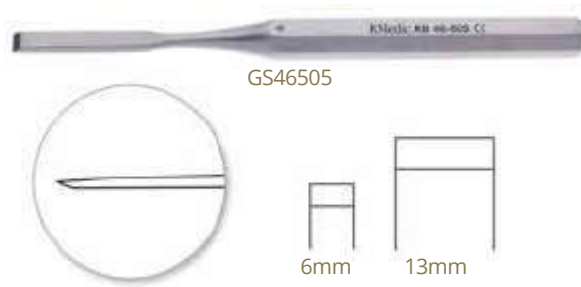

Straight, 5-1/4" (13.5 cm).

Catalog #	Description
GS46505	3/16" (4 mm)
GS46506	1/4" (6 mm)
GS46507	3/8" (10 mm)
GS46508	1/2" (13 mm)
GS46509	3/4" (19 mm)

CHISELS AND GOUGES

Chisels

ORTHOPEDIC INSTRUMENTS

LEXER CHISELS



GS49248

Phenolic handle, 8-5/8" (22 cm).

Catalog #	Description
GS49246	5mm
GS49248	7mm
GS49250	10mm
GS49252	15mm
GS49254	20mm
GS49256	25mm
GS49258	30mm

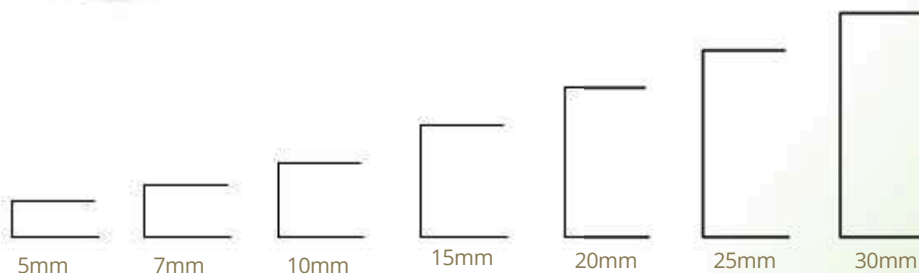

LEXER MINI CHISELS



GS49260

Phenolic handle, 7-1/8" (18 cm).

Catalog #	Description
GS49260	4mm
GS49262	6mm
GS49264	8mm
GS49266	10mm
GS49268	12mm



STILLE-TYPE CHISELS



GS49012

8-1/8" (20.5 cm).

Catalog #	Description
GS49010	10mm
GS49012	14mm
GS49014	18mm
GS49016	22mm

CHISELS AND GOUGES

Gouges

ALEXANDER GOUGES



7" (18 cm).

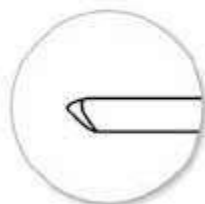

GS49052

Catalog #	Description
GS49050	4mm
GS49051	6mm
GS49052	8mm
GS49053	10mm
GS49054	12mm
GS49055	14mm



4mm



6mm



8mm



10mm



12mm



14mm

U.S. ARMY PATTERN GOUGES



7" (18 cm).

GS46292

Catalog #	Description
GS46292	6mm
GS46293	12mm
GS46294	14mm



6mm



12mm



14mm

CHISELS AND GOUGES

Gouges

ORTHOPEDIC INSTRUMENTS

STILLE-TYPE GOUGES



GS49018

8" (20.5 cm).

Catalog #	Description
GS49018	10mm
GS49020	14mm
GS49022	18mm
GS49024	22mm

SHOULDER PENETRATING GOUGE



GS46919

Catalog #	Description
GS46919	3 mm tip, 8-1/2" (21.5 cm)

SMITH PETERSON GOUGES

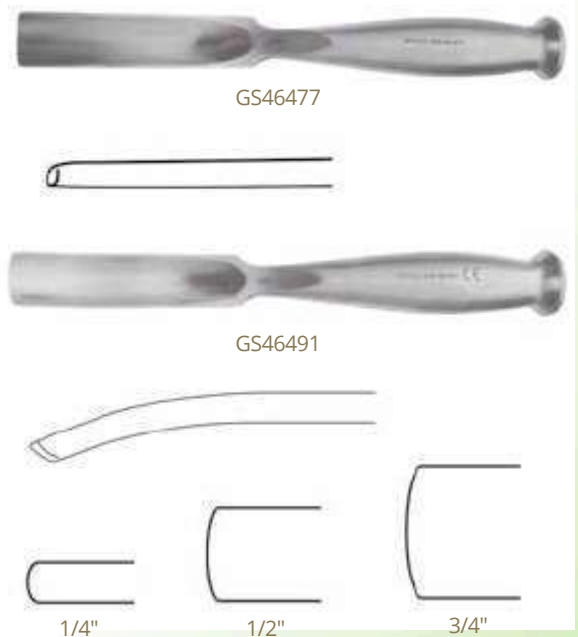

GS46477

GS46491

Catalog #	tip	tip width
GS46466	Straight	1/4"
GS46467	Straight	1/4"
GS46468	Straight	3/8"
GS46476	Straight	1/2"
GS46477	Straight	5/8"
GS46478	Straight	3/4" 1"
GS46479	Straight	1-1/4"
GS46487	Curved	1/4"
GS46488	Curved	3/8"
GS46489	Curved	1/2"
GS46490	Curved	5/8"
GS46491	Curved	3/4"
GS46493	Curved	1"
GS46495	Curved	1-1/4"

1/4"

1/2"

3/4"

CHISELS AND GOUGES



Gouges

HIBBS GOUGES



9" (23 cm).



GS46391

GS46407

1/4"



1/2"

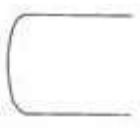

3/4"



1"



1-1/4"

Catalog #	tip	tip width
GS46387	Straight	1/4"
GS46388	Straight	3/8"
GS46389	Straight	1/2"
GS46390	Straight	5/8"
GS46391	Straight	3/4"
GS46392	Straight	7/8"
GS46393	Straight	1"
GS46394	Straight	1-1/8"
GS46395	Straight	1-1/4"
GS46401	Straight	1-1/2"
GS46402	Curved	1/4"
GS46403	Curved	3/8"
GS46404	Curved	1/2"
GS46405	Curved	5/8"
GS46407	Curved	3/4"
GS46408	Curved	7/8"
GS46409	Curved	1"
GS46410	Curved	1-1/8"
GS46411	Curved	1-1/4"
GS46412	Curved	1-1/2"

SWAN NECK GOUGE



GS49084

DIO UC48094RS

Catalog #	Description
GS49084	1" distal tip, 9" (23 cm)

SR 49084 CU, Old



CHISELS AND GOUGES

Gouges

ORTHOPEDIC INSTRUMENTS

ROBB-TYPE SPINAL GOUGES



GS49032

All stainless, with knurled handle, 5/32" (7 mm) distal tip, 11" (28 cm).



GS49030



GS49032



GS49034



GS49036

Catalog #	Description
GS49030	Straight
GS49032	Medium curve
GS49034	Strong curve
GS49036	Reverse curve

HIBBS ENDOSCOPIC GOUGE



GS55630

Straight tip, stainless steel handle, 18-1/2" (47 cm).



Catalog #	tip Width	tip length	shaft length	shaft Diameter	hanDle length
GS55630	0.28" (7 mm)	3-1/2"	10-3/4"	0.43"	4-1/4"

BONE TAMPS AND IMPACTORS

Bone Tamps

BONE TAMPERS



Cross-serrated tip, 6-1/4" (16 cm).

GS46896



Catalog #	Description
GS46893	2 mm diameter
GS46894	3mm
GS46895	4mm
GS46896	5mm
GS46897	6mm
GS46898	8mm
GS46899	10mm

BONE IMPACTOR



Designed to tap bone graft or bone parts into place with minimal trauma to the bone. The compactor head is nylon with a grid surface to prevent slippage.



GS69980

Catalog #	Description
GS69980	Anodized aluminum handle with replaceable nylon caps, head diameter 20 mm, 6-1/2" (16.5 cm)

BONE CHIP PACKERS



Stainless steel handle, 9-7/8" (25 cm).

GS49751



Catalog #	Description
GS49750	3mmx16mm
GS49751	2mmx9mm
GS49752	6mmx9mm
GS49753	6mmx19mm
GS49754	1/4" (5 mm)

BONE TAMPS AND IMPACTORS

Impactors

ORTHOPEDIC INSTRUMENTS

ENDOSCOPIC BONE TAMP

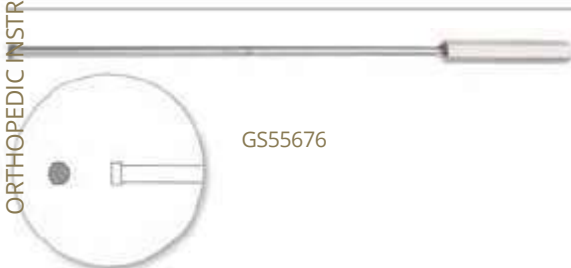

GS55676

Straight, stainless steel handle, 17" (43 cm).

Catalog #	tip Width	tip length	shaft length	shaft Diameter	handle length
GS55676	3/8" (10 mm)	0.16"	12.59"	0.280" (7.1 mm)	4-1/4"

LUMBAR AND CERVICAL IMPACTORS AND DRIVERS



GS55373

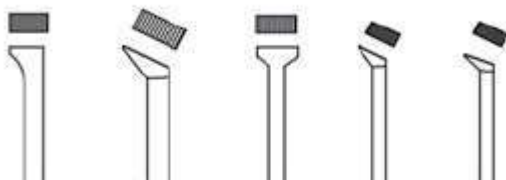

GS55370

GS55371

GS55372

GS55373

GS55374

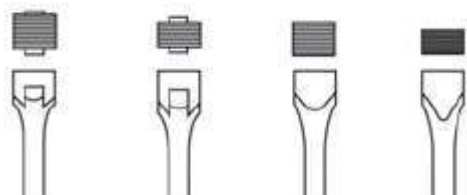

GS55375

GS55376

GS55377

GS55378

Catalog #	Description
GS55370	Impactor, standard offset, 6 mm x 12 mm, 8-1/2" (21.5 cm)
GS55371	Impactor, central canal, 7 mm x 16 mm, 8-1/2" (21.5 cm)
GS55372	Impactor, lateral narrow, 6 mm x 13 mm, 8-1/2" (21.5 cm)
GS55373	Impactor, micro offset, 4 mm x 9.5 mm, 7" (18 cm)
GS55374	Impactor, micro lateral, 4 mm x 10 mm, 7" (18 cm)
GS55375	Graft driver, lumbar, guarded, 10 mm x 13 mm, 8-1/2" (21.5 cm)
GS55376	Graft driver, anterior, guarded, 7 mm x 13 mm, 8-1/2" (21.5 cm)
GS55377	Graft driver, lumbar, unguarded, 10 mm x 13 mm, 8-1/2" (21.5 cm)
GS55378	Graft driver, anterior, unguarded, 7 mm x 13 mm, 8-1/2" (21.5 cm)

ESOPHAGOSCOPES

ESOPHAGOSCOPES

Esophagoscopes have been designed in conjunction with the innovators in esophageal surgery for examination, diagnostic procedures and removal of foreign bodies in the

esophagus. These fiberoptic scopes have been designed for ease of insertion. A variety of sizes and configurations are offered to meet the patient's specific needs.

. ESOPHAGOSCOPE PATIENT SIZE LISTING

Catalog # proDUCt naMe

NEONATE/INFANT ESOPHAGOSCOPES

523570 Holinger
523505 HolingerSpeculum

CHILD/PEDIATRIC ESOPHAGOSCOPES

523600P Jackson
523602 Jackson
523650P Jesberg
523652 Jesberg
523640 Pillsbury-Jesberg
523642 Pillsbury-Jesberg
523571 Holinger
523572 Holinger
523675 Forbes

ADOLESCENT ESOPHAGOSCOPES

523654 Jesberg
523644 Pillsbury-Jesberg
523573 Holinger
523574 Holinger
523575 Holinger

Catalog # proDUCt naMe

ADULT ESOPHAGOSCOPES

523602 Jackson
523604 Jackson
523608 Jackson
523610P Jackson
523612 Jackson
523614 Jackson
523656 Jesberg
523658 Jesberg
523660P Jesberg
523646 Pillsbury-Jesberg
523648 Pillsbury-Jesberg
523649 Pillsbury-Jesberg
523577 Holinger
523579 Holinger
523581 Holinger
523582 Holinger
523677 Forbes

ESOPHAGOSCOPES

Pillsbury-Jesberg Design

NEW PILLSBURY-JESBERG ESOPHAGOSCOPES



523648

The Pillsbury-Jesberg Esophagoscopes were designed with the light carrier fully incorporated into the textured handle. With this improved design, there is built-in protection for the light carrier during normal handling. The barrel and tip of the scope follow the familiar Jesberg design, facilitating gentle insertion while maintaining usual technique. Supplied with one light carrier. Blue fiber optic cable sold separately (see pg. 467).

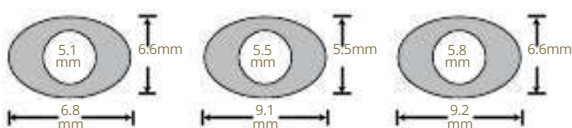

523640

523642

523644

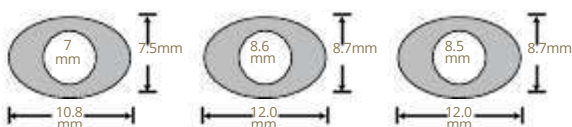

523646

523648

523649

Drawings illustrate Nominal Proximal Internal Dimensions and Minimum Internal Diameter (I.D.), NOT TO SCALE.

Catalog #	sScope size	overall length	Min i.D.	noMinal proximal DiMensions	Max o.D.	replaCe Carrier
523640	6x8x32	317 mm	5.1 mm	6.6x6.8 mm	12.0 mm	526640
523642	6.5 x 10 x 35	349 mm	5.5 mm	5.5x9.1 mm	15.2 mm	526642
523644	7x10x42	421 mm	5.8 mm	6.6x9.2 mm	15.3 mm	526644
523646	8x12x45	452 mm	7.0 mm	7.5x10.8 mm	15.9 mm	526646
523648	10x14x29	292 mm	8.6 mm	8.7x12.0 mm	19.5 mm	526648
523649	10x14x50	500 mm	8.5 mm	8.7x12.0 mm	19.2 mm	526649

Jesberg Design

JESBERG OVAL ESOPHAGOSCOPES



523650P

The oval tube used in the construction of this scope is thickened at its distal end to form a protective edge and finished to a smooth shape. Supplied with one light carrier. Blue fiber optic cable sold separately (see pg. 467).

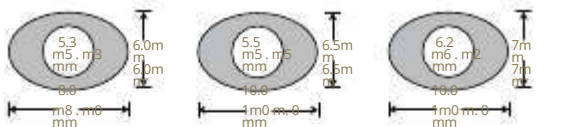

523650P

523652

523654

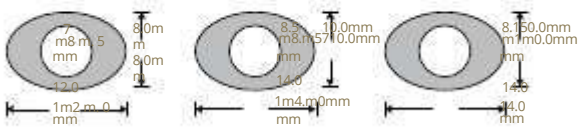

523656

523658

523660P

Drawings illustrate Nominal Proximal Internal Dimensions and Minimum Internal Diameter (I.D.), NOT TO SCALE.

Catalog #	sScope size	overall length	Min i.D.	noMinal proximal DiMensions	Max o.D.	replaCe Carrier
523650P	6x	320 mm	5.3 mm	6.0x8.0 mm	12.6 mm	526268
523652	8x32	349 mm	5.5 mm	6.5x10.0 mm	15.7 mm	526270
523654	6.5x10 x 35	421 mm	5.8 mm	7.0x10.0 mm	16.2 mm	526276
523656	7x	452 mm	7.0 mm	8.0x12.0 mm	15.4 mm	526278
523658	8x	291 mm	8.5 mm	10.0x14.0 mm	18.5 mm	526264
523660P	12 x 45	291 mm	8.5 mm	10.0x14.0 mm	18.5 mm	526264
523660P	14 x 29	504 mm	8.5 mm	10.0x14.0 mm	19.2 mm	526282
523660P	10x	504 mm	8.5 mm	10.0x14.0 mm	19.2 mm	526282
523660P	14 x 50	504 mm	8.5 mm	10.0x14.0 mm	19.2 mm	526282

ESOPHAGOSCOPES

Holinger Design

HOLINGER FIBEROPTIC ESOPHAGOSCOPES



Designed by Dr. Paul Holinger, these fiberoptic esophagoscopes provide a nearly full view of the lumen with 5.4mm constant cool illumination. Special features of

- Large fiber bundle for increased distal illumination.
- Aspiration channel on the exterior of the scope to permit maximum lumen.
- Oval fiber optic light carrier to allow more viewing area in instrumentation room in main tube.
- Smooth distal tip.
- 15 mm proximal end for attachment of accessories.
- Blue 12f.7ibmm optic cable sold separately (see pg. 467).

Holinger Fiberoptic Esophagoscopes are supplied with one 8.5mm light carrier and one window plug (522595).

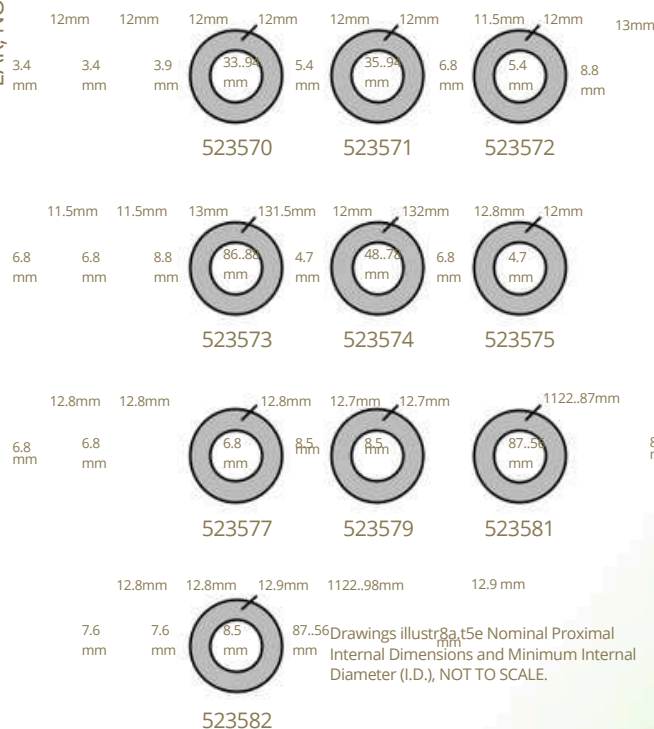

Drawings illustrate Nominal Proximal Internal Dimensions and Minimum Internal Diameter (I.D.), NOT TO SCALE.

Catalog #	sCope size	overall length	Min i.D.	noMinal proxiMal i.D.	Max o.D.	replaCe Carrier
523570	3.5x 30	300mm	3.4mm	12.0mm	14.5mm	527510 300mm
523571	4x30	300mm	3.9mm	12.0mm	15.0mm	527510
523572	6x30	300mm	5.4mm	12.0mm	15.6mm	527550
523573	7x30	300mm	6.8mm	11.5mm	16.0mm	527550
523574	9x30	300mm	8.8mm	13.0mm	20.0mm	527575 349mm
523575	5x35	451mm	4.7mm	12.0mm	15.0mm	527515
523577	7x45	451mm	6.8mm	12.8mm	14.6mm	527565
523579	9x53	530mm	8.5mm	12.7mm	21.0mm	527585
523581	8x45	451mm	7.6mm	12.8mm	19.0mm	527583
523582	9x45	451mm	8.5mm	12.9mm	20.0mm	527583

Dimensions are without window plug.

ESOPHAGOSCOPES

Jackson Design

JACKSON FIBER OPTIC OVAL ESOPHAGOSCOPES



In the oval model, the distal end is slightly flared to form a blunt, smooth edge without increasing the bulk of the tip unnecessarily. The light carrier is placed on the right side of the tube so that the cord is directed away from the hand of the operator. Supplied with one light carrier. Blue fiber optic cable sold separately (see pg. 467).

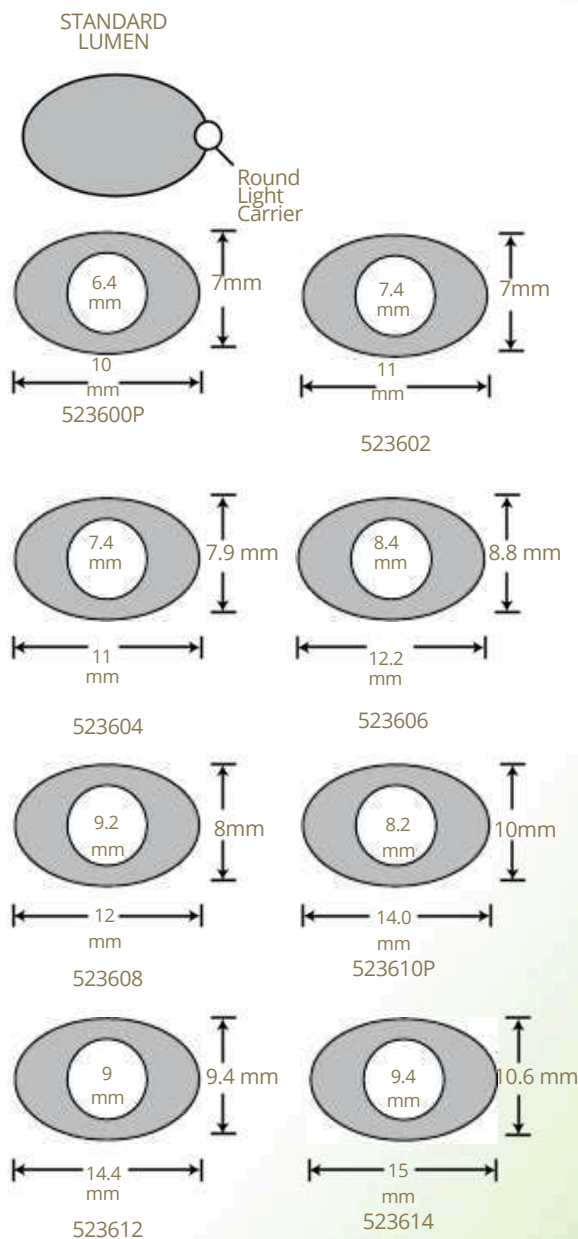

Catalog #	sCope size	overall length	Min i.D.	noMinal proximal DiMensions	Max o.D.	replaCe Carrier
523600P	7x	251	6.4	7.0 x	14.2	526262
	10 x 25	mm	mm	10.0 mm	mm	
523602	8x	502	7.4	7.0 x	15.5	526284
	12 x 50	mm	mm	11.0 mm	mm	
523604	9x	251	7.4	7.9 x	16.6	526262
	13 x 25	mm	mm	11.0 mm	mm	
523606	10 x	302	8.4	8.8 x	18.0	526266
	14 x 30	mm	mm	12.2 mm	mm	
523608	10 x	401	9.2	8.0 x	17.8	526274
	14 x 40	mm	mm	12.0 mm	mm	
523610P	10 x	502	8.2	10.0 x	17.5	526284
	14 x 50	mm	mm	14.0 mm	mm	
523612	12 x	502	9.0	9.4 x	18.8	526284
	16 x 50	mm	mm	14.4 mm	mm	
523614	12 x	350	9.4	10.6 x	20.7	526272
	18 x 35	mm	mm	15.0 mm	mm	

Drawings illustrate Nominal Proximal Internal Dimensions and Minimum Internal Diameter (I.D.), NOT TO SCALE.

ESOPHAGOSCOPES

Specula

FORBES ESOPHAGEAL SPECULA



523675

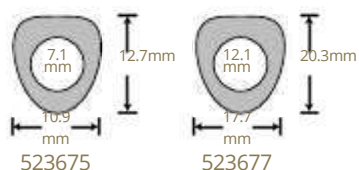

523675

523677

These specula are used for the retrieval of foreign objects lodged in the cervical esophagus. The lumen of these instruments is slightly off the round and the tube tapers gradually to the distal end. The length of the bevel of the tip varies according to the size of the instrument. Particularly useful in the removal of coins. Supplied with one light carrier. Blue fiber optic cable sold separately (see pg. 467).

Catalog #	sCope size	overall length	Min i.D.	noMinal proxiMal DiMensions	Max o.D.	replaCe Carrier
523675	Child	161 mm	7.1 mm	10.9 x 12.7 mm	14.4 mm	526020
523677	Adult	222 mm	12.1 mm	17.7 x 20.3 mm	23.0 mm	526046

HOLINGER INFANT ESOPHAGEAL SPECULUM



523505

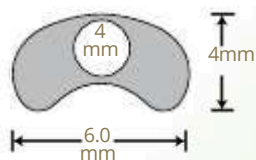

523505

The Holinger Infant Esophageal Speculum was designed for esophageal foreign body problems in small children. The length is adequate to reach foreign objects lodged in the cervical esophagus without the disadvantage of excess length. Supplied with one light carrier. Blue fiber optic cable sold separately (see pg. 467).

Catalog #	sCope size	overall length	Min i.D.	noMinal proxiMal DiMensions	Max o.D.	replaCe Carrier
523505	6x20	200 mm	4.0 mm	4.0 x 6.0 mm	10.0 mm	526218

INSTRUMENTATION FOR BRONCHOSCOPES AND ESOPHAGOSCOPES

The . Bronchial and Esophageal Instruments have been designed to meet the needs that may arise during the endoscopic surgical procedure. Biopsy forceps, grasping forceps, retrieval forceps, aspirating tubes and other related instruments have been designed specifically in length and diameter to be used with the appropriately sized . Scope.

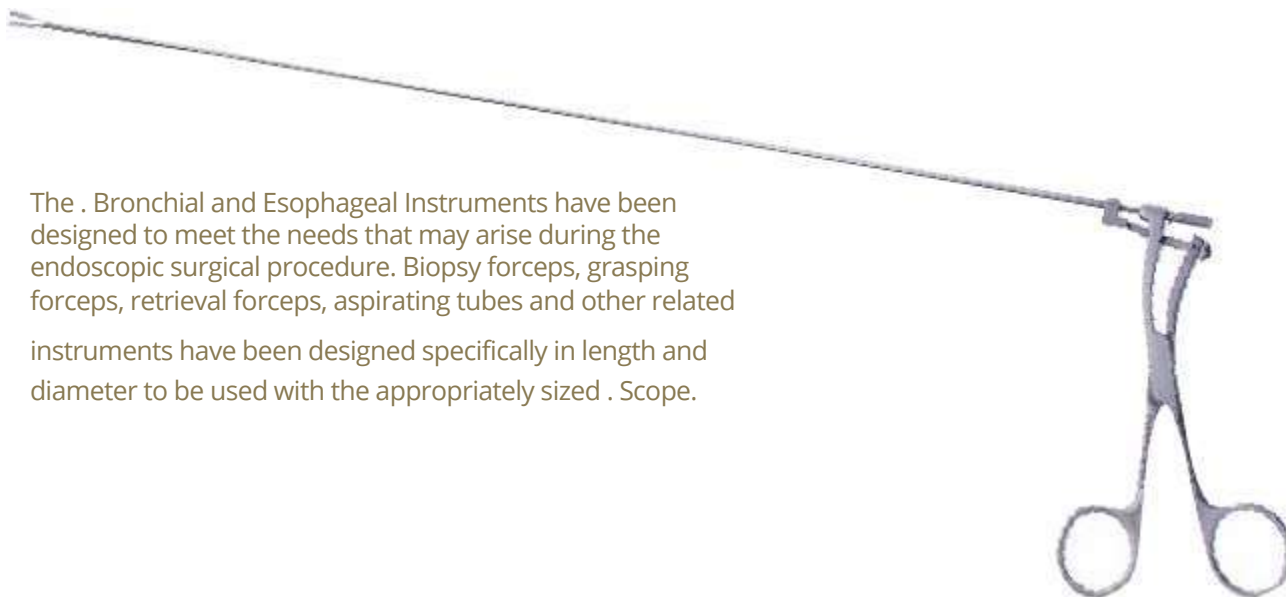

Biopsy Cup Forceps

EXTRA-LIGHTWEIGHT CONSTRUCTION FORCEPS



Very light shafts with small cup biting jaws, straight or slightly angled.

Catalog #	CUp DiaMeter	shape	Working length	For Use thrU sCopes
505160	2mm	Straight	35cm	4.0 mm or larger
505162	2mm	Straight	40cm	4.0 mm or larger
505166	2mm	Angular	35cm	4.0 mm or larger
505168	2mm	Angular	40cm	4.0 mm or larger

INSTRUMENTATION FOR BRONCHOSCOPES AND ESOPHAGOSCOPES

Biopsy Cup Forceps

HOLINGER CUP BITING SPECIMEN FORCEPS

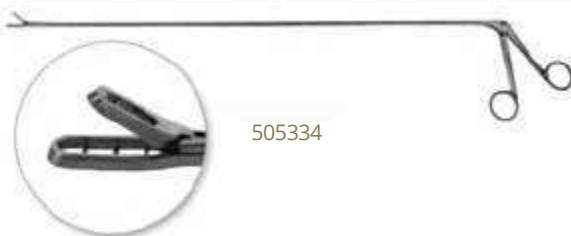

505334

Cutting jaws with rounded tip and basket designed to prevent crushing of specimen. Cutting edges extend into box of instrument to permit clean, complete removal of specimen.

Catalog # 505334	Cup DiaMeter 5mm	shape Straight	Working length 60cm	For Use thru sCopes 7.0 mm or larger
---------------------	------------------------	-------------------	---------------------------	-----------------------------------------

JACKSON SQUARE PUNCH SPECIMEN FORCEPS

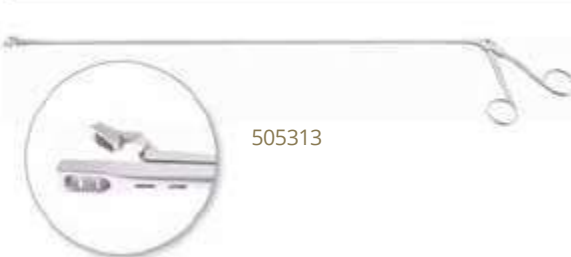

505313

Basket built into lower blade to hold excised tissue.

Catalog # 505313	Cup DiaMeter 5mm	shape Straight	Working length 45cm	For Use thru sCopes 6.0 mm or larger
---------------------	------------------------	-------------------	---------------------------	-----------------------------------------

INSTRUMENTATION FOR BRONCHOSCOPES AND ESOPHAGOSCOPES

Biopsy Cup Forceps

SAM ROBERTS CUP BIOPSY FORCEPS - MOST POPULAR

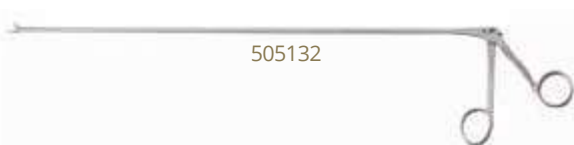

Roberts Forceps have jaws specially shaped and angled for use through bronchoscopes and esophagoscopes of definite sizes.



505113

505130

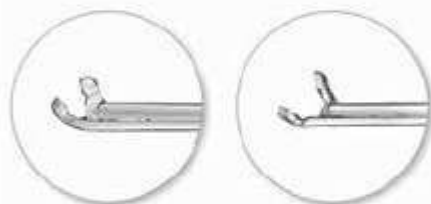

505123

505146



505148

Catalog #	Cup DiaMeter	shape	Working length	For Use thrU stD. BronCh	For Use thrU esophagosCopes
505113	2 mm	Straight	50 cm	4.5 mm	3.5 mm
505130	4 mm	Straight	40 cm	7.0 mm	7.0 mm
505132	4 mm	Straight	50 cm	7.0 mm	7.0 mm
505134	4 mm	Straight	60 cm	7.0 mm	7.0 mm
505136	6 mm	Straight	40 cm	9.0 mm	9.0 mm
505138	6 mm	Straight	50 cm	9.0 mm	9.0 mm
505140	6 mm	Straight	60 cm	9.0 mm	9.0 mm
505123	2 mm	Angular	50 cm	4.5 mm	3.5 mm
505142	4 mm	Angular	40 cm	8.0 mm	8.0 mm
505144	4 mm	Angular	50 cm	8.0 mm	8.0 mm
505146	4 mm	Angular	60 cm	8.0 mm	8.0 mm
505148	6 mm	Angular	40 cm	10.0 mm	10.0 mm
505150	6 mm	Angular	50 cm	10.0 mm	10.0 mm
505152	6 mm	Angular	60 cm	10.0 mm	10.0 mm

INSTRUMENTATION FOR BRONCHOSCOPES AND ESOPHAGOSCOPES

Grasping Forceps

JACKSON ALLIGATOR GRASPING FORCEPS - DOUBLE-ACTION



Double articulating jaws are finely serrated and grooved. For use through bronchoscopes or esophagoscopes.

Catalog #	JaW Width x length	Working length	For Use thru sCopes
505414	2.5 x 14 mm	50cm	5.0 mm or larger
505415	2.5 x 14 mm	60cm	5.0 mm or larger

JACKSON ALLIGATOR GRASPING FORCEPS - LIGHT CONSTRUCTION



Finely serrated tapered jaws. For use through bronchoscopes or esophagoscopes.

Catalog #	JaW Width x length	Working length	For Use thru sCopes
505420	1.5 x 17 mm	30cm	5.0 mm or larger
505422	1.5 x 17 mm	40cm	5.0 mm or larger

JACKSON ALLIGATOR GRASPING FORCEPS - EXTRA DELICATE



For use through infant laryngoscopes and 3.5 mm bronchoscopes.

Catalog #	JaW Width x length	Working length
505432	2.3 x 12 mm	30cm
505433	2.3 x 12 mm	35cm

JACKSON ALLIGATOR GRASPING FORCEPS - STANDARD



For use through bronchoscopes or esophagoscopes.

Catalog #	JaW Width x length	Working length	For Use thru sCopes
505400	4x23mm	28cm	6.0 mm or larger
505402	4x23mm	35cm	6.0 mm or larger
505403	4x23mm	40cm	6.0 mm or larger
505404	4x23mm	50cm	6.0 mm or larger
505406	4x23mm	60cm	6.0 mm or larger

INSTRUMENTATION FOR BRONCHOSCOPES AND ESOPHAGOSCOPES

Grasping Forceps

JACKSON ROTATION FORCEPS



Serrated jaws terminate in sharp teeth. Standard forceps are sturdily constructed with large, strong teeth for use through bronchoscopes and esophagoscopes. Delicate forceps feature light construction with small, sharp teeth. Stainless Steel.

Catalog #	Description	Jaw Width x length	Working length	For Use thru Scopes
505462	Delicate light	2.4 x 10 mm	30cm	3.5 mm or larger
505463	Delicate light	2.4 x 10 mm	35cm	3.5 mm or larger
505450	Standard	4x20mm	28cm	3.5 mm or larger
505455	Standard	4x20mm	50cm	7.0 mm or larger
505456	Standard	4x20mm	60cm	7.0 mm or larger

CLERF-ARROWSMITH SAFETY PIN CLOSING FORCEPS

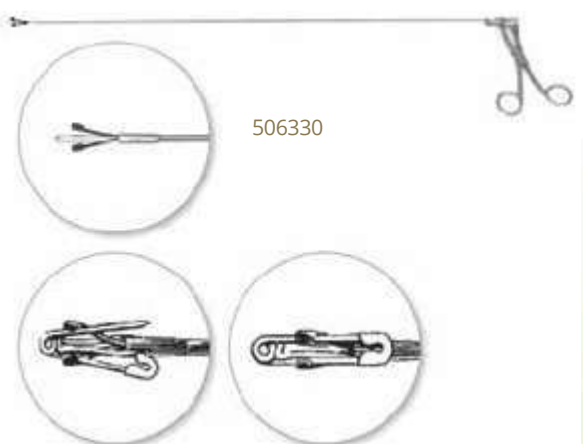

A notched brace pushes the loop of the pin away from the jaws which simultaneously grasps the limbs of the pin. This action results in approximation of the point and keeper.

Catalog #	Working length	For Use thru Scopes	Construction Weight
506330	45cm	5.0 mm or larger	7/8" - 1-1/2"
506331	50cm	5.0 mm or larger	7/8" - 1-1/2"

GORDON BEAD GRASPING FORCEPS

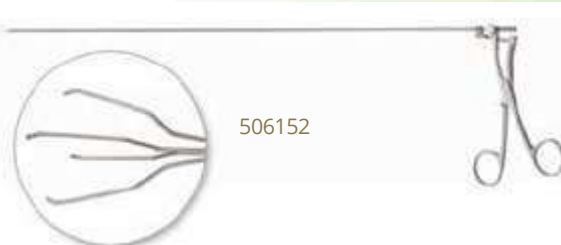

The four-bladed grasping unit is designed to completely surround a slippery, hard-surfaced, smooth object such as an oval bead or ball-bearing.

Catalog #	Working length	For Use thru Scopes	Construction Weight
506150	45cm	5.0 mm or larger	Small
506152	50cm	6.0 mm or larger	Large

INSTRUMENTATION FOR BRONCHOSCOPES AND ESOPHAGOSCOPES

Grasping Forceps

JACKSON DOUBLE PRONG GRASPING FORCEPS



506251



Powerful, fenestrated, deeply serrated blades with distal points are especially valuable in grasping teeth and similar difficult objects.

Catalog #	Working length	For Use thru sCopes	Construction Weight
506251	45cm	5.0 mm or larger	Medium
506252	50cm	5.0 mm or larger	Medium

JACKSON DULL-POINTED RING ROTATION FORCEPS



506232



Catalog #	Working length	For Use thru sCopes	Construction Weight
506220	35cm	3.5 mm or larger	Extra-Small
506232	60cm	mm or larger	Large

JACKSON FENESTRATED MEAT GRASPING FORCEPS



506075



Large, deeply serrated blades.

Catalog #	(MM) length	For Use thru sCopes	Construction Weight
506075	50cm	7.0 mm or larger	Large
506076	60cm	7.0 mm or larger	Large

JACKSON FENESTRATED PEANUT GRASPING FORCEPS



506070



Jaws considerably lighter and smaller than meat grasping forceps.

Catalog #	Working length	For Use thru sCopes	Construction Weight
506060	35cm	3.5 mm or larger	Extra-Small
506063	35cm	4.0 mm or larger	Small
506070	60cm	5.0 mm or larger	Medium

INSTRUMENTATION FOR BRONCHOSCOPES AND ESOPHAGOSCOPES

Grasping Forceps

JACKSON FORWARD GRASPING CUP FORCEPS



These cannulated forceps are constructed entirely of stainless steel. The jaws are carefully shaped and set to provide a secure grip on the object to be removed. They are strong and durable and will sustain any degree of traction it is safe to exert. Serrated, cupped jaws in various sizes.

Catalog #	Working length	For Use thru sCopes	ConstrUCtion Weight
506000	35cm	3.0 mm or larger	Extra-Small
506003	35cm	4.0 mm or larger	Small
506004	40cm	4.0 mm or larger	Small
506008	40cm	4.0 mm or larger	Medium
506016	50cm	5.0 mm or larger	Large
506017	60cm	5.0 mm or larger	Large

JACKSON FORCEPS PARTS KIT



Contains various sizes of screws and pivot pins for Jackson cannulated-style forceps.

Catalog #	Description
508590	12 parts total

JESBERG FENESTRATED GRASPING FORCEPS

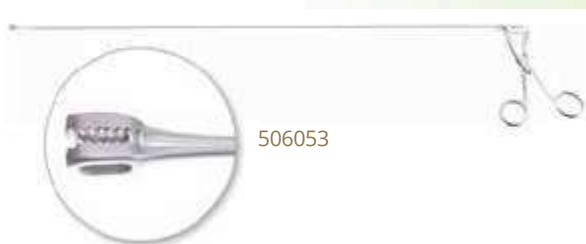

A multi-purpose forceps with fenestrated blades shaped to encircle an odd-shaped or globular object. Valuable as a forward grasping forceps for pebbles, beads, peanuts, meat, head presented tacks and nails. Light construction weight.

Catalog #	Working length	For Use thru sCopes	ConstrUCtion Weight
506053	50cm	4.0 mm or larger	Light

INSTRUMENTATION FOR BRONCHOSCOPES AND ESOPHAGOSCOPES

Grasping Forceps

TUCKER BEAD GRASPING FORCEPS

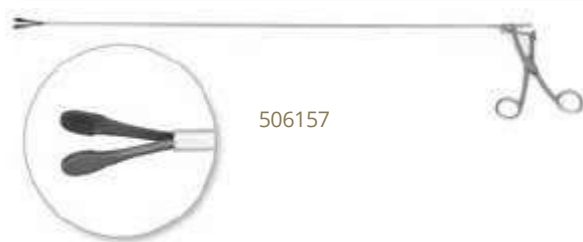

506157

Forceps have stiff, expanding springs and jaws designed to grasp over and beyond the greatest circumference of the bead. Blades are concave and back-serrated at the tip for secure grasp.

Catalog #	Working length	For Use thru Scopes	Construction Weight
506155	40cm	4.0 mm or larger	5.0 Small
506157	50cm	mm or larger	Medium

KAHLER GRASPING FORCEPS



505515

Jaws contain a series of teeth that provide a very secure grip on most foreign bodies.

Catalog #	Jaw Width x length	Working length	For Use thru Scopes
505515	4x13mm	60cm	6.0 mm or larger

INSTRUMENTATION FOR BRONCHOSCOPES AND ESOPHAGOSCOPES

Grasping Forceps

. DELICATE CENTER-ACTION BRONCHOSCOPIC FORCEPS

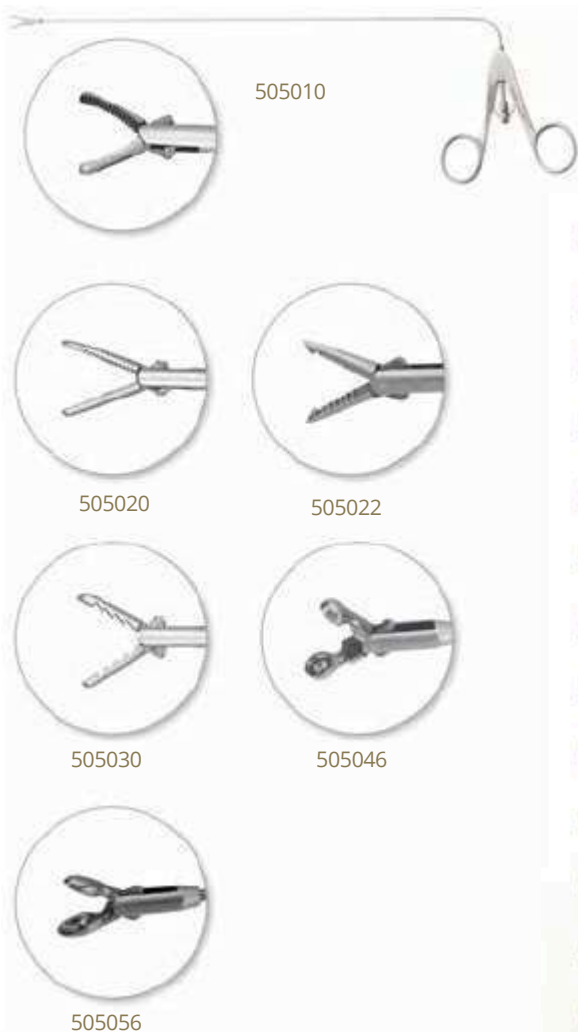

The slender stem allows for greater visibility. Center-action handle and double-action jaws eliminate tendency of distal end to pull away from object and rise. Stem does not bend under pressure from handles. Stainless steel construction.

Catalog #	Description	Working length	For Use thru Scopes
505005	Fenestrated, cupped grasping	38 cm	3.5 mm or larger
505010	Fenestrated, cupped grasping	38 cm	4.0 mm or larger
505014	Fenestrated, cupped grasping	50 cm	4.0 mm or larger
505016	Alligator grasping	38 cm	4.0 mm or larger
505018	Alligator grasping	45 cm	4.0 mm or larger
505020	Alligator grasping	50 cm	4.0 mm or larger
505022	Rotation, 1 x 2 teeth	38 cm	4.0 mm or larger
505028	Kahler grasping	38 cm	4.0 mm or larger
505030	Kahler grasping	45 cm	4.0 mm or larger
505032	Kahler grasping	50 cm	4.0 mm or larger
505046	Circular cup biopsy forceps	38 cm	5.0 mm or larger
505048	Circular cup biopsy forceps	45 cm	5.0 mm or larger
505050	Circular cup biopsy forceps	50 cm	5.0 mm or larger
505056	Oval cup biopsy forceps	50 cm	5.0 mm or larger

INSTRUMENTATION FOR BRONCHOSCOPES AND ESOPHAGOSCOPES

Forceps for Pediatric and Laser Scopes

PEDIATRIC BRONCHOSCOPIC INSTRUMENTS



These miniature grasping and biopsy forceps and scissors with 2 mm stems have been designed to pass through the smaller pediatric bronchoscopes. The stems are slightly angled at the handle, affording unobstructed vision. Straight forward, 35 cm working length, will pass through a 3 mm or larger scope, 5 degree bend at handle.

Catalog #	Description	shape	Working length	For Use thru sCopes
505650	Grasping forceps	Straight forward	36 cm	3.0 mm or larger
505654	Biopsy forceps	Straight cup	36 cm	3.5 mm or larger
505662	Biopsy forceps	Oval cup	37 cm	3.5 mm or larger

. FLEXIBLE ENDOSCOPIC FORCEPS



The . Flexible Forceps were designed for use with . Laser and Standard Bronchoscopes. They easily pass through the instrument/fiber channel for the purpose of biopsy, foreign body retrieval and removal of char from laser ablation. These forceps are available in 1 mm and 2 mm sizes.

Catalog #	overall length	Description	For Use thru sCopes
505670	36.5 cm	1 mm alligator grasping	3.5 x 20 4.0 x 25
505674	36.5 cm	1 mm oval cup biopsy	3.5 x 20 4.0 x 25
505680	40 cm	1.5 mm alligator grasping, flexible	5.0 x 30 6.0 x 35
505682	40 cm	2 mm fenestrated grasping, flexible	5.0 x 30 6.0 x 35
505686	50 cm	2 mm alligator grasping, flexible	7.0 x 40 8.0 x 40 9.0 x 40
505690	50 cm	2 mm circular cup biopsy	7.0 x 40 8.0 x 40 9.0 x 40

INSTRUMENTATION FOR BRONCHOSCOPES AND ESOPHAGOSCOPES

Suction Tubes

HOLINGER ASPIRATING TUBES

Holinger Tubes have an open distal tip as well as two opposing side openings. This allows for complete, rapid aspiration without clogging. These tubes are available in a standard model without thumb-valve and the thumb-valve control model.

Standard Model



Catalog #	Working length	For Use thru sCopes	tUBe DiaMeter
507050	45cm	5.0 mm or larger	4 mm (12 Fr.)
507051	50cm	5.0 mm or larger	4 mm (12 Fr.)
507052	60cm	5.0 mm or larger	4 mm (12 Fr.)
507055	25cm	4.0 mm or larger	3 mm (9 Fr.)
507057	35cm	4.0 mm or larger	3 mm (9 Fr.)

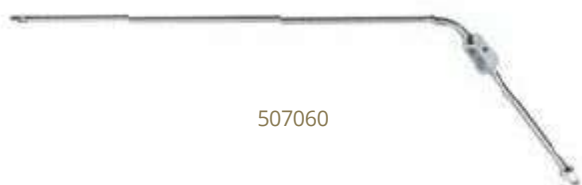

Thumb Valve Control Model

Catalog #	Working length	tUBe DiaMeter
507060	20cm	3 mm (9 Fr.)
507065	35cm	4 mm (12 Fr.)

For use through infant laryngoscopes for tracheal aspiration.

JACKSON "VELVET-EYE" ASPIRATING TUBES

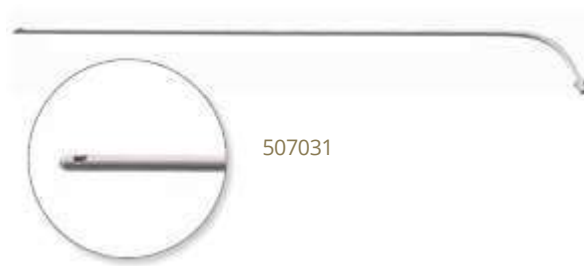

These tubes have a smooth, oval-shaped opening on each side of the distal tip and a closed, blunt end.

Catalog #	Working length	For Use thru sCopes	tUBe DiaMeter
507030	20cm	5.0 mm or larger	4 mm (12 Fr.)
507031	35cm	5.0 mm or larger	4 mm (12 Fr.)
507032	40cm	5.0 mm or larger	4 mm (12 Fr.)
507033	45cm	5.0 mm or larger	4 mm (12 Fr.)
507034	50cm	5.0 mm or larger	4 mm (12 Fr.)
507035	60cm	5.0 mm or larger	4 mm (12 Fr.)
507040	35cm	4.0 mm or larger	3 mm (9 Fr.)
507041	40cm	4.0 mm or larger	4 mm (12 Fr.)

INSTRUMENTATION FOR BRONCHOSCOPES AND ESOPHAGOSCOPES

Suction Tubes

JACKSON OPEN END ASPIRATING TUBE

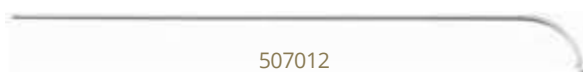

507012

. Aspirating Tubes, except in special designs, are constructed of stainless steel. They are measured in working length from distal tip to beginning of proximal curve or angle. Aspirating tubes should be 5 cm or 10 cm longer than the instruments through which they are used.

Catalog#	Working length	For Use thru Scopes	tUBE Dia Meter
507010	20cm	5.0 mm or larger	4mm(12Fr.)
507011	35cm	5.0 mm or larger	4mm(12Fr.)
507012	40cm	5.0 mm or larger	4mm(12Fr.)
507013	45cm	5.0 mm or larger	4mm(12Fr.)
507014	50cm	5.0 mm or larger	4mm(12Fr.)
507015	60cm	5.0 mm or larger	4mm(12Fr.)
507020	35cm	3.0 mm or larger	2.0mm(6Fr.)
507023	35cm	3.5 mm or larger	2.6mm(8Fr.)
507027	35cm	4.0 mm or larger	3.0mm(9Fr.)
507028	40cm	4.0 mm or larger	3.0mm(9Fr.)

FULLY INSULATED SUCTION TUBE



507048

Catalog#	Description
507048	With thumb-valve, 12 Fr. tip, working length 19-5/8" (50 cm). Supplied w/10 ft. Bovie cord and plug (507046)

BOVIE CORD FOR SUCTION TUBE



507046

Catalog#	Description
507046	Replacement Bovie cord and plug for 507048, 10 ft.

INSTRUMENTATION FOR BRONCHOSCOPES AND ESOPHAGOSCOPES

Coagulation Suction Tubes

COAGULATION SUCTION TUBES



809600

Disposable foot control coagulation suction tubes, sterile, 10 per box.

Catalog #	Description
809600	11 French, with stylet, 6" (15 cm)
809610	11 French, with stylet, 8" (20.5 cm)

EXTENDED LENGTHOPEN

EXTENDED LENGTH/OPEN BARIATRIC

Knife Handles/Suction Tubes

KNIFE HANDLES



175055

Catalog #	Description
175055	#3, 16" (40.5 cm)
175056	#3, 18" (45.5 cm)

YANKAUER SUCTION TUBES

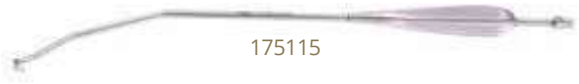

175115

Catalog #	Description
175114	12" (30.5 cm)
175115	14" (35.5 cm)
175116	16" (40.5 cm)
175117	18" (45.5 cm)

POOLE SUCTION TUBES



175086

Catalog #	Description
175083	30 Fr. tip, 12" (30.5 cm)
175084	30 Fr. tip, 16" (40.5 cm)
175085	30 Fr. tip, 18" (45.5 cm)
175086	14" (35.5 cm)

Forceps and Clamps

THUMB TISSUE FORCEPS



175109

Catalog #	Description
175109	1 x 2 teeth, 16" (40.5 cm)
175110	1 x 2 teeth, 18" (45.5 cm)

POTTS SMITH FORCEPS



175087

Catalog #	Description
175087	14" (35.5 cm)
175088	1 x 2 teeth, 14" (35.5 cm)

EXTENDED LENGTH/OPEN BARIATRIC

Forceps and Clamps

RUSSIAN TISSUE FORCEPS



175105

Catalog #	Description
175104	12" (30.5 cm)
175105	14" (35.5 cm)
175106	16" (40.5 cm)

DEBAKEY® TISSUE FORCEPS



175030P

Catalog #	Description
175026	12" (30.5 cm), TC
175027	14" (35.5 cm), 2 mm
175028	16" (40.5 cm), 2 mm
175029	18" (45.5 cm), 2 mm
175030P	14" (35.5 cm), 3 mm
175031	16" (40.5 cm), 3 mm
175032	18" (45.5 cm), 2.5 mm

GERALD DRESSING FORCEPS



175037

Catalog #	Description
175037	12" (30.5 cm)

SINGLEY DRESSING FORCEPS



175107

Catalog #	Description
175107	Serrated, 16" (40.5 cm)
175108	Serrated, 18" (45.5 cm)

FOERSTER SPONGE FORCEPS



175036

Catalog #	Description
175033	Straight, 12" (30.5 cm)
175034	Straight, 14" (35.5 cm)
175035	Straight, 16" (40.5 cm)
175036	Straight, 18" (45.5 cm)

EXTENDED LENGTH/OPEN BARIATRIC

Forceps and Clamps

ALLIS TISSUE FORCEPS



175001

Catalog #	Description
175000	12" (30.5 cm)
175001	14" (35.5 cm)
175002	16" (40.5 cm)
175003	18" (45.5 cm)
175004	X-action, 18" (45.5 cm)

BABCOCK TISSUE FORCEPS

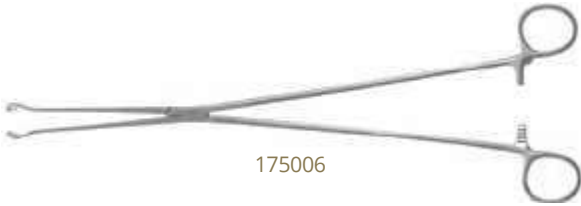

175006

Catalog #	Description
175005	12" (30.5 cm)
175006	14" (35.5 cm)
175007	16" (40.5 cm)
175008	18" (45.5 cm)
175009	X-action, 18" (45.5 cm)

BRIDGE X-ACTION FORCEPS



175010P

Catalog #	Description
175010P	Curved, 18" (45.5 cm)

CARMALT FORCEPS



175011

Catalog #	Description
175011	Curved, 12" (30.5 cm)

CLARK ARTERY FORCEPS

Catalog #	Description
175012	Curved, 16" (40.5 cm)
175013	Curved, 18" (45.5 cm)

EXTENDED LENGTH/OPEN BARIATRIC

Forceps and Clamps

COLLIER ANDERSON CLAMPS



175017

Catalog #	Description
175016	10" (25.5 cm)
175017	11" (28 cm)
175018	14" (35.5 cm)
175019	16" (40.5 cm)

KANTROWITZ RIGHT ANGLE FORCEPS



175054

Catalog #	Description
175053	12" (30.5 cm)
175054	14" (35.5 cm)

MIXTER RIGHT ANGLE FORCEPS



175073

Catalog #	Description
175073	16" (40.5 cm)
175074	18" (45.5 cm)

MIXTER RIGHT ANGLE FORCEPS



175093

Catalog #	Description
175093	14" (35.5 cm)
175094	18" (45.5 cm)

EXTENDED LENGTH/OPEN BARIATRIC

Forceps and Clamps

RIGHT ANGLE CLAMP



Catalog #
175092

Description
16" (40.5 cm)

175092

RIGHT ANGLE X-ACTION FORCEPS



Catalog #
175095

Description
18" (45.5 cm)

175095

KOCKER X-ACTION FORCEPS



Catalog #
175057

Description
Straight, serrated, 1 x 2 teeth, 18" (45.5 cm)

175057

TONSIL CLAMP



Catalog #
175111

Description
14" (35.5 cm)

175111

TONSIL FORCEPS

Catalog #
175112

Description
Straight, serrated, 16" (40.5 cm)

EXTENDED LENGTH/OPEN BARIATRIC

Forceps and Clamps

ZENKER FORCEPS

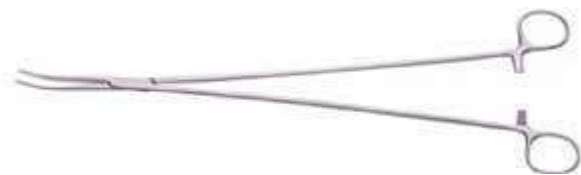

175113

Catalog #
175113

Description
Straight, 14" (35.5 cm)

ROCHESTER OCHSNER FORCEPS



175101

Catalog #
175096
175100
175101

Description
Straight, serrated, 1 x 2 teeth, 18" (45.5 cm)
Straight, 14" (35.5 cm)
Straight, serrated, 1 x 2 teeth, 16" (40.5 cm)

ROCHESTER PEAN FORCEPS

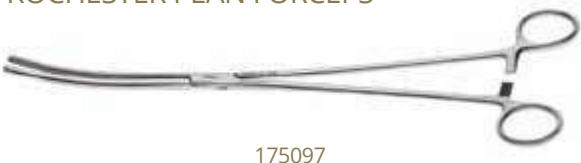

175097

Catalog #
175097
175098

Description
Curved, 14" (35.5 cm)
Curved, 18" (45.5 cm)

ROCHESTER PEAN HEMOSTATIC FORCEPS

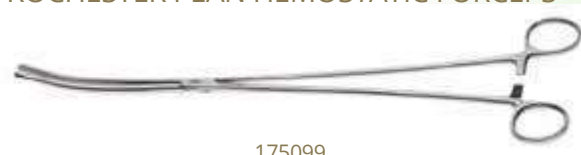

175099

Catalog #
175099

Description
16" (40.5 cm)

CLARK HYSTERECTOMY CLAMPS

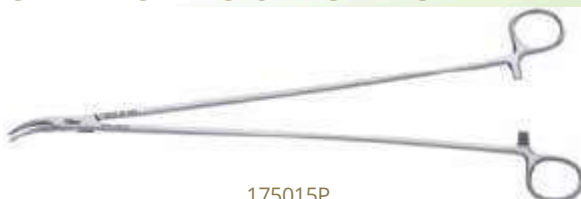

175015P

Catalog #
175014
175015P

Description
12" (30.5 cm)
14" (35.5 cm)

EXTENDED LENGTH/OPEN BARIATRIC

Forceps and Clamps

HEANEY BALLENTINE CLAMPS



Catalog #	Description
175038	Curved, 12" (30.5 cm)
175039	Straight, 12" (30.5 cm)

MASTERTON HYSTERECTOMY FORCEPS



Catalog #	Description
175059	Curved, 10" (25.5 cm)
175060	Straight, 10" (25.5 cm)

ROGERS HYSTERECTOMY FORCEPS



Catalog #	Description
175102	Curved, 10" (25.5 cm)
175103	Straight, 10" (25.5 cm)

EXTENDED LENGTH/OPEN BARIATRIC

Forceps and Clamps

Z-HYSTERECTOMY FORCEPS

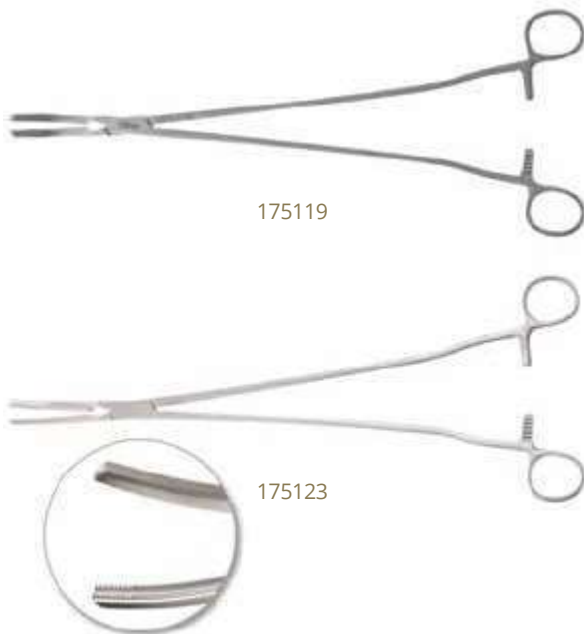

Catalog #	Description
175118	Angled, 12" (30.5 cm)
175119	Angled, 14" (35.5 cm)
175120	Straight, 12" (30.5 cm)
175121	Straight, 14" (35.5 cm)
175122	Slight curved, 12" (30.5 cm)
175123	Slight curved, 14" (35.5 cm)
175124	Full curved, 12" (30.5 cm)
175125	Full curved, 14" (35.5 cm)

Scissors

COOLEY SCISSORS



Catalog #	Description
175020P	Curved, 12" (30.5 cm)

EXTENDED LENGTH/OPEN BARIATRIC Scissors

HYSTERECTOMY SCISSORS



Catalog #	Description
175042	Curved, 10-1/2" (26.5 cm), TC
175043	Curved, 12" (30.5 cm), TC
175045	Medium curved, 10-1/2" (26.5 cm), TC
175046	Medium curved, 12" (30.5 cm), TC
175048	Acutely curved, 10-1/2" (26.5 cm), TC
175049	Acutely curved, 12" (30.5 cm), TC

175046

JORGENSON SCISSORS



Catalog #	Description
175052	Acutely curved, 14" (35.5 cm)

175052

MAYO HARRINGTON SUPER-CUT SCISSORS



Catalog #	Description
175061	Medium curved, 12" (30.5 cm)

175061

MAYO SCISSORS



Catalog #	Description
175067	Medium curved, 14" (35.5 cm), TC
175068	Medium straight, 14" (35.5 cm), TC

175067

EXTENDED LENGTH/OPEN BARIATRIC

Scissors

METZENBAUM SCISSORS



Catalog #	Description
175069	Curved, 12" (30.5 cm), TC
175070	Curved, 14" (35.5 cm), TC
175072	Curved, 16" (40.5 cm), TC
175071	Curved, 18" (45.5 cm), TC

NELSON METZENBAUM SCISSORS



Catalog #	Description
175075	Curved, 16" (40.5 cm)
175076	Curved, 18" (45.5 cm)

NELSON METZENBAUM SUPER-CUT SCISSORS



Catalog #	Description
175077	Supercut, curved, 11-3/4" (30 cm)

POTTS TENOTOMY SCISSORS



Catalog #	Description
175089	Curved, 10" (25.5 cm)
175090	Curved, 12" (30.5 cm)
175091	Curved, 14" (35.5 cm)

EXTENDED LENGTH/OPEN BARIATRIC Needle Holders

CRILE WOOD NEEDLE HOLDERS

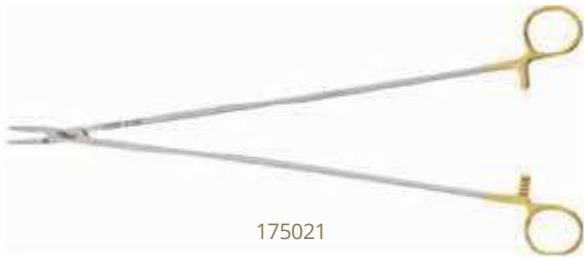

175021

Catalog #	Description
175021	14" (35.5 cm), TC
175022	16" (40.5 cm), TC

HEANEY NEEDLE HOLDERS



175041

Catalog #	Description
175040P	12" (30.5 cm), TC
175041	14" (35.5 cm), TC

MASSON NEEDLE HOLDER



175058

Catalog #	Description
175058	16" (40.5 cm), TC

EXTENDED LENGTH/OPEN BARIATRIC Needle Holders

MAYO HEGAR NEEDLE HOLDERS



Catalog #	Description
175062	12" (30.5 cm), TC
175066	14" (35.5 cm), TC
175063	18" (45.5 cm), TC

MAYO MASSON NEEDLE HOLDER



Catalog #	Description
175065	18" (45.5 cm), TC

EXTENDED LENGTH/OPEN BARIATRIC Needle Holders

NOLAN NEEDLE HOLDERS

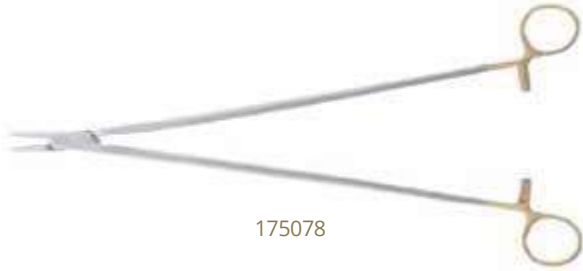

Catalog #	Description
175078	14" (35.5 cm), TC
175079	16" (40.5 cm)
175080	Curved, 16" (40.5 cm), TC
175081	16" (40.5 cm), TC
175082	18" (45.5 cm)

Retractors

CUSHING VEIN RETRACTORS



Catalog #	Description
175023	12-1/2" (32 cm)
175024	14" (35.5 cm)
175025P	16" (40.5 cm)

FLOOR GRADE INSTRUMENTS

FLOOR GRADE INSTRUMENTS

Forceps

IN-EX ADSON DRESSING FORCEPS



101149

Catalog #
101149

Description
Serrated, 4-3/4" (12 cm), 12 per box

IN-EX ADSON TISSUE FORCEPS



101150

Catalog #
101150

Description
1 x 2 teeth, 4-3/4" (12 cm), 12 per box

IN-EX THUMB FORCEPS



101148

Catalog #
101147
101148

Description
Serrated, 5-1/2" (14 cm), 12 per box
1 x 2, 5-1/2" (14 cm), 12 per box

FLOOR GRADE INSTRUMENTS

Forceps

IN-EX BACKHAUS TOWEL CLAMPS



101023

Catalog #	Description
101022	3-1/2" (9 cm), 12 per box
101023	5-1/4" (13.5 cm), 12 per box

IN-EX EDNA TOWEL CLAMP



101028

Catalog #	Description
101028	5-3/8" (13.5 cm), 12 per box

IN-EX HOFF TOWEL CLAMP



101024

Catalog #	Description
101024	Non-perforating, 5-3/4" (14.5 cm), 12 per box

FLOOR GRADE INSTRUMENTS

Forceps

IN-EX SPONGE FORCEPS



101151

Catalog #
101152
101151

Description
Ballenger, serrated, 7-1/4" (18.5 cm), 12 per box
Foerster, serrated, 9-3/4" (25 cm), 12 per box

IN-EX HALSTED MOSQUITO FORCEPS



101010

Catalog #
101010
101011

Description
Straight, 5" (12.5 cm), 12 per box
Curved, 5" (12.5 cm), 12 per box

IN-EX CRILE FORCEPS



101016

Catalog #
101016
101017

Description
Straight, 5-1/2" (14 cm), 12 per box
Curved, 5-1/2" (14 cm), 12 per box

FLOOR GRADE INSTRUMENTS

Forceps

IN-EX KELLY FORCEPS



Catalog #	Description
101012	Straight, 5-1/2" (14 cm), 12 per box
101013	Curved, 5-1/2" (14 cm), 12 per box

IN-EX ROCHESTER-PEAN FORCEPS



Catalog #	Description
101014	Straight, 6-1/2" (16.5 cm), 12 per box
101015	Curved, 6-1/2" (16.5 cm), 12 per box

IN-EX ALLIS TISSUE FORCEPS



Catalog #	Description
101027	4 x 5 teeth, 6-1/4" (16 cm), 12 per box

FLOOR GRADE INSTRUMENTS

Forceps

IN-EX BOZEMAN UTERINE DRESSING FORCEPS



101033

Catalog #	Description
101033	Straight, 10" (25.5 cm)
101034	Curved, 10-3/8" (26.5 cm)

Needle Holders

IN-EX BAUMGARTNER NEEDLE HOLDER



101032

Catalog #	Description
101032	12.5 x 2.7 mm jaw, 5-1/2" (14 cm), 12 per box

IN-EX WEBSTER NEEDLE HOLDER



101031

Catalog #	Description
101031	15.5 x 1.7 mm smooth jaw, 5" (12.5 cm), 12 per box

FLOOR GRADE INSTRUMENTS

Needle Holders

IN-EX MAYO HEGAR NEEDLE HOLDERS



Catalog #	Description
101130	20 x 2.8 mm jaw, 6-1/2" (16.5 cm), 12 per box
101131	24 x 3 mm jaw, 8" (20.5 cm), 12 per box

Scissors

IN-EX LISTER BANDAGE SCISSORS



Catalog #	Description
101142	5-3/4" (14.5 cm), 12 per box
101143	7-1/4" (18.5 cm), 12 per box

IN-EX LITTAUER SUTURE SCISSORS



Catalog #	Description
101146	5-1/2" (14 cm), 12 per box

FLOOR GRADE INSTRUMENTS

Scissors

IN-EX WIRE SCISSORS



101039

Catalog #
101039

Description
4-3/4" (12 cm), 12 per box

IN-EX IRIS SCISSORS



101145

Sharp/Sharp.

Catalog #
101144
101145

Description
Straight, 4-1/2" (11.5 cm), 12 per box
Curved, 4-1/2" (11.5 cm), 12 per box

IN-EX OPERATING SCISSORS

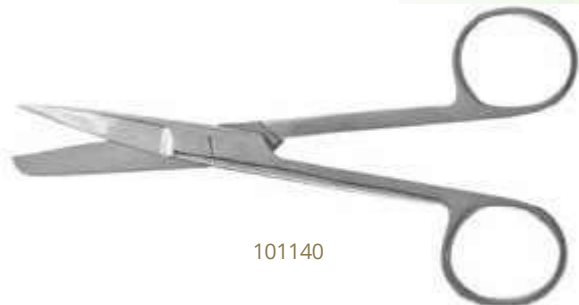

101140

Catalog #
101140
101141

Description
Straight, Sharp/Blunt, 5-1/2" (14 cm), 12 per box
Straight, Sharp/Sharp, 5-1/2" (14 cm), 12 per box

FLOOR GRADE INSTRUMENTS

Scissors

IN-EX MAYO SCISSORS



101035



101036



101038

Catalog #
101035
101036
101037
101038

Description

Straight, 5-1/2" (14 cm), 12 per box
Curved, 5-1/2" (14 cm), 12 per box
Straight, 6-3/4" (17 cm), 12 per box
Curved, 6-3/4" (17 cm), 12 per box

MALLETS

MALLETS

Light and Medium Weight Mallets

NARROW TIP MALLET



GS49764

Useful for hand surgery and in areas where access is limited.

Catalog #	Weight	head Weight	head Diameter	overall length
GS49764	7oz (198 g)	3oz (85 g)	18 x 18 mm (square contact surface) 7 mm (round contact surface)	8" (20.5 cm)

Autoclavable to 290°F (143°C)

SOLID COPPER HEAD MALLET

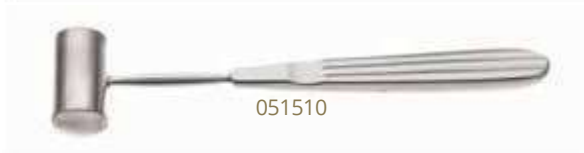

051510

Catalog #	Weight	head Diameter	overall length
051510	4 oz (113 g)	3/4" (20 mm)	6-1/2" (16.5 cm)

MINI MALLET



GS49765

Solid stainless steel.

Catalog #	Weight	head Weight	head Diameter	overall length
GS49765	4 oz (113 g)	3 oz (85 g)	20mm	7" (18 cm)

MALLETS

Light and Medium Weight Mallets

ORTHOPEDIC INSTRUMENTS

BUCAE BONE MALLETS



Solid stainless steel handles.

Catalog #	Weight	head	head Weight	head Diameter	overall length
GS49761	7oz (198 g)	Stainless steel	3oz (85 g)	19mm	7-1/2" (19 cm)
GS46660	9oz (260 g)	Brass	5oz (142 g)	25mm	8" (20.5 cm)

MALLET #49



Lead filled and faced.

Catalog #	Weight	head Weight	head Diameter	overall length
GS46656	7 oz (198 g)	5 oz (142 g)	22mm	7-3/4" (19.5 cm)

Lead filled mallets should only be used to strike flat surfaces. Do not use to hit sharp objects as doing so can lead to flake off.

MALLET



Lightweight. Includes two replaceable nylon caps, anodized aluminum handle.

Catalog #	Weight	head Weight	head Diameter	overall length
GS46662	7 oz (198 g)	4 oz (113 g)	25mm	7-1/2" (19 cm)

Autoclavable to 250°F (121°C)

MALLET CAPS



Catalog #	Description
GS46662P	Pair of nylon caps for GS46662, 1" (2.5 cm)

MALLETS

Light and Medium Weight Mallets

NYLON HEAD MALLETS



Catalog #	Weight	head Diameter	overall length
051520	8 oz (227 g)	1" (25 mm)	7-1/2" (19 cm)
051525	11 oz (312 g)	1-1/4" (32 mm)	7-5/8" (19.5 cm)



NYLON HEAD MALLET FACES



Catalog #	Description
051521	Extra 1" nylon face for 051520
051526	Extra 1-1/2" nylon face for 051525

COLLIN MALLETT



Solid stainless steel.

Catalog #	Weight	head Weight	head Diameter	overall length
GS49760	7 oz (198 g)	5 oz (142 g)	30mm	8" (20.5 cm)

MALLETS

Light and Medium Weight Mallets

ORTHOPEDIC INSTRUMENTS

WELCH MALLETT



441420

Catalog #	Weight	overall length
441420	7.7 oz (218 g)	7-7/8" (20 cm)

MEAD MALLETT



GS46657

Includes replaceable nylon caps.

Catalog #	Weight	head Weight	head Diameter	overall length
GS46657	11 oz (315 g)	6 oz (170 g)	20mm	7-1/2" (19 cm)

Autoclavable to 250°F (121°C)

GERZOG BONE MALLETT



GS46661

Lead filled and faced.

Catalog#	Weight	head Weight	head Diameter	overall length
GS46661	10oz(285g)	7oz(200g)	25mm	7-1/2" (19 cm)

Lead filled mallets should only be used to strike flat surfaces. Do not use to hit sharp objects as doing so can lead to flake off.

MALLETS

Light and Medium Weight Mallets

BERGMAN MALLETS



Aluminum alloy handle.

Catalog #	Weight	head Weight	head Diameter	overall length
GS49766	15 oz (425 g)	9 oz (255 g)	30mm	8-7/8" (22.5 cm)
GS49767	1lb1oz(482g)	11 oz (312 g)	45mm	9-1/2" (24 cm)

COMBINATION MALLETS



With one nylon cap and one solid stainless side.

Catalog #	Weight	head Weight	head Diameter	overall length
GS46686	9 oz (260 g)	5 oz (142 g)	25mm	7-1/2" (19 cm)
GS46687	12 oz (340 g)	8 oz (227 g)	32mm	7-1/2" (19 cm)

COMBINATION Mallet CAPS



GS46687P

With one nylon cap and one solid stainless side.

Catalog #	Description
GS46686P	Nylon cap for GS46686, 1" (2.5 cm)
GS46687P	Nylon cap for GS46687, 1-1/4" (3.2 cm)

MALLETS

Light and Medium Weight Mallets

ORTHOPEDIC INSTRUMENTS

LOWARD-STYLE MALLETS



GS55400

Solid stainless steel.

Catalog #	Weight	heaD Weight	heaD Diameter	Ball peen Diameter	overall length
GS55400	8 oz (227 g)	4 oz (113 g)	20.5 mm	17.5 mm	7-1/2" (19 cm)
GS55401	16 oz (454 g)	8 oz (227 g)	25 mm	22 mm	9" (23 cm)

ORTHOPEDIC MALLETS



GS49763

Solid stainless steel.

Catalog #	hanDle length	Weight	heaD Weight	heaD Diameter	overall length
GS49763	Short	1lb2oz (510 g)	8oz (227 g)	30.5 mm	7" (18 cm)
GS46666	Normal	2lbs (900 g)	1lb (455 g)	32mm	10-3/4" (27.5 cm)



GS46666

MALLETS

Heavyweight Mallets

KIRK MALLET



Brass filled with stainless steel face.

head Diameter

Catalog #	Weight	head Weight	head Diameter	overall length
GS46658	1lb7oz (650 g)	1lb4oz (570 g)	38mm	8" (20.5 cm)

Head is brass filled and should only be used to strike flat surfaces.

HEATH MALLET



Heavyweight, solid stainless steel.

Catalog #	Weight	head Weight	head Diameter	overall length
GS46663	2lbs (907 g)	1lb4oz (570 g)	40mm	7-1/2" (19 cm)

ORTHOPEDIC MALLETS



Solid stainless steel.

Catalog #	handle length	Weight	head Weight	head Diameter	overall length
GS49762	Short	2lbs (900 g)	1lb5oz (595 g)	38mm	7-1/2" (19 cm)
GS46667	Normal	3lbs (1360 g)	2 lbs (900 g)	50mm	11" (28 cm)

MALLETS

Heavyweight Mallets

ORTHOPEDIC INSTRUMENTS

PHENOLIC HANDLE MALLETS



GS46688

Grooved phenolic handle for comfortable and safe grip.

GS46688	1 lb 11 oz (765 g)	1 lb (455 g)	32mm	11" (28 cm)
GS46689	2 lbs 9 oz (1162 g)	2 lbs (900 g)	45mm	11" (28 cm)

REPERCUSSION FREE MALLET



GS46690

Also known as a dead blow mallet. One nylon cap and one stainless steel side. Grooved phenolic handle for comfortable grip.

Catalog #	Weight	head Weight	head diameter	overall length
GS46690	1lb5oz (600 g)	10 oz (285 g)	30mm	11" (28 cm)

Autoclavable to 250°F (121°C)

REPERCUSSION FREE MALLET CAP



GS46690P

Catalog #	Description
GS46690P	Cap only for GS46690

MEDIASTINOSCOPY

MEDIASTINOSCOPY

Mediastinoscopes

CARLENS MEDIASTINOSCOPES



522301

The Carlens Mediastinoscopes come in short, long and extra-long lengths. The short model is suitable for inspection of the mediastinum above the bifurcation, while the long and extra-long models are designed for the region of the carina. Supplied with one light carrier.

Catalog #	scope size	overall length	Min. i.D.	nominal proximal Dimensions	Max o.D.	replace Carrier
522300P	Short	116 mm	10.8 mm	16.0 mm	18.4 mm	526350
522301	Long	162 mm	11.0 mm	18.0 mm	22.3 mm	526351
522302	Extra-Long	191 mm	11.9 mm	19.0 mm	22.3 mm	526352



Drawings illustrate Nominal Proximal Internal Dimensions and Minimum Internal Diameter (I.D.), NOT TO SCALE

IMPROVED TUCKER MEDIASTINOSCOPE



522311

The Improved Tucker Mediastinoscope has the highest light output of any mediastinoscope and is suited for use in conjunction with the operating microscope. Scope is supplied with an extra-large diameter fiber optic light carrier and integral 6 ft. long, autoclaveable connecting cable.

Catalog #	scope size	overall length	Min. i.D.	nominal proximal Dimensions	Max o.D.	replace Carrier
522306	Short	147 mm	12.8 mm	24.1 x 14.2 mm	23.3 mm	527853
522311	Long	180 mm	12.3 mm	27.0 x 15.0 mm	23.2 mm	527850

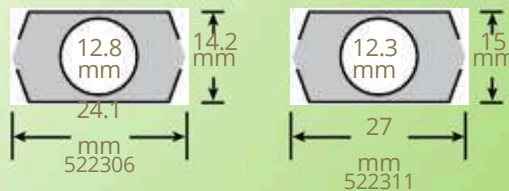

Drawings illustrate Nominal Proximal Internal Dimensions and Minimum Internal Diameter (I.D.), NOT TO SCALE

MEDIASTINOSCOPY

Instrumentation

ASPIRATING NEEDLE

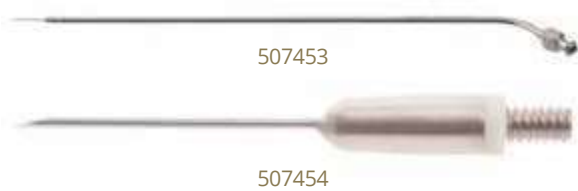

507453

507454

Catalog #

507453

507454

Description

Reinforced angled shaft, with protective cover, distal needle 23 Ga., working length 8-1/4" (21 cm)

Spare distal needle tip for aspirating needle

INSULATED SUCTION CAUTERY TUBE



507045

Fully insulated with thumb-valve for controlled suction.

Catalog #

507045

Description

Supplied with 10 ft (305 cm) Bovie Cord and plug (507046)

BOVIE CORD FOR SUCTION TUBE



507046

For insulated suction.

Catalog #

507046

Description

10 ft (305 cm)

MEDIASTINOSCOPY

Instrumentation

BOVIE PENCIL HANDLE



351970

With connecting cord.

Catalog#	Description
351970	5-1/8" (13 cm)

JACKSON ALLIGATOR GRASPING FORCEPS



505400

Catalog#	Description
505400	Standard, deeply serrated and grooved jaws, 4 mm wide by 23 mm long, working length 11-1/8" (28 cm)
505420	Small, finely serrated jaws taper from 3 mm to 1.55 mm width, 17 mm long, working length 11-3/4" (30 cm)

JACKSON CUP FORCEPS - STANDARD, MEDIUM LIGHTWEIGHT



505100

Jackson Forceps come in standard and extra-lightweight construction that provides durability and strength. The jaw size, shape and angle are specially calculated for use through Jackson scopes.

Catalog#	Description
505100	Straight, 4 mm diameter jaw, working length 28 cm
505104	Angled, 4 mm diameter jaw, working length 28 cm

MEDIASTINOSCOPY

Instrumentation

JACKSON CUP FORCEPS - EXTRA LIGHTWEIGHT



Jackson Forceps come in standard and extra-lightweight construction that provides durability and strength. The jaw size, shape and angle are specially calculated for use through Jackson scopes.

Catalog #	Description
505110	Straight, 2 mm diameter jaw, working length 20 cm
505112	Straight, 2 mm diameter jaw, working length 28 cm
505114	Angled, 2 mm diameter jaw, working length 20 cm
505116	Angled, 2 mm diameter jaw, working length 28 cm

PATTERSON ELONGATED CUP BITING FORCEPS

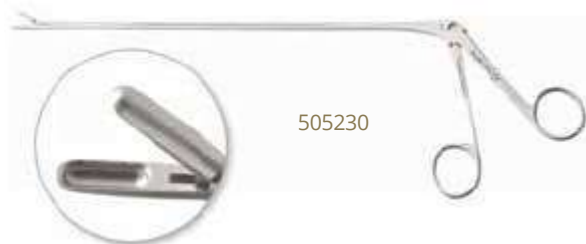

Catalog #	Description
505230	Regular, 4 mm jaw width, 11-1/8" (28 cm)

MEDIASTINAL BLUNT-TIPPED DISSECTING FORCEPS



Catalog #	Description
506748	Serrated, 16 mm tip, working length 7-1/2" (19 cm), 12" (31 cm)

MEDIASTINOSCOPY

Instrumentation

NORRIS SPONGE HOLDING FORCEPS



Bayonet-shaped, cross action forceps designed for use in mediastinoscopy. Straight distal portion of jaw is 16 cm long.

Catalog #
506747

Description
Straight, serrated, 3.6 mm tip, 13-1/8" (34 cm)

Scope Holders

TOBEY LARYNGOSCOPE HOLDER



The laryngoscope/mediastinoscope holder with a quick attach/release mechanism that provides a secure hold of your laryngoscope. With the blue thumb tab mechanism on the Tobey Laryngoscope Holder, there is no more twisting or turning necessary to lock the laryngoscope into the holder. The Tobey Laryngoscope Holder also allows for fine-tune adjusting using the size adjustment knob for different laryngoscope handles.

Catalog #
502248

Description
Overall width, 9" (23 cm)

MEDIASTINOSCOPY

Clips and Appliers

ALLIGATOR APPLYING FORCEPS AND LIGATING CLIPS

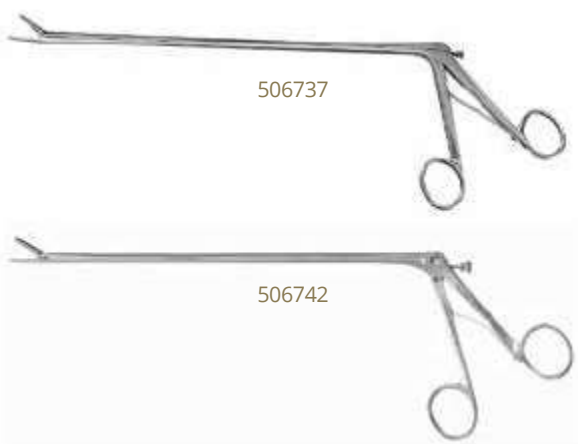

Drew and Scoville forceps for use with McKenzie "V" clips and Duane "U" clips. Jaw opening is controlled by screw mechanism in handle. Stainless steel. Length 9-3/4" (25 cm). McKenzie and Duane clips are non-magnetic and made of Sterling Silver.

Catalog #	Description
506737	Drew Forceps, serrated jaws
506742	Scoville Forceps, slotted jaws
506743	McKenzie "V" clips, smooth, vial of 100
506744	McKenzie "V" clips, serrated, vial of 100
506746	Duane "U" clips, smooth, vial of 100
506749	Clip holding magazine, single row, weighted, manual loading for Duane and McKenzie clips



506743



506744

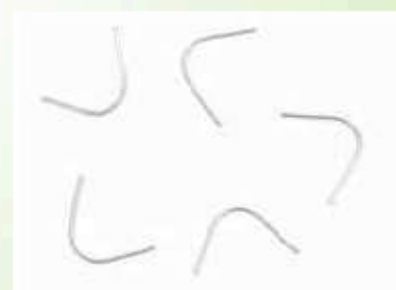

506746



506749

MICRO CLIPS AND APPLIERS

MICRO CLIPS AND APPLIERS

Temporary Vessel Clips

KLEINERT-KUTZ MICRO VESSEL CLIPS



065105

Catalog #
065100
065105

Description
Straight blade, 1 x 3 mm, 0.34" (8.5 mm)
Straight blade, 1 x 5 mm, 0.40" (10 mm)

KLEINERT-KUTZ MICRO VESSEL CLIPS



065145

Catalog #
065125
065145

Description
Angled blade, 1 x 5 mm
Curved blade, 1 x 6 mm

TEMPORARY OCCLUSION CLIPS



065108

Catalog #
065108
065109

Description
7 x 2 mm blade
12 x 2 mm blade

MICRO CLIPS AND APPLIERS

Temporary Vessel Clips

MINI WECK® MICRO VESSEL APPROXIMATOR



065166

Catalog #	Description
065166	5 x 1 mm blades, 7/16" (11 mm) bar

LOUISVILLE MICRO VESSEL APPROXIMATOR WITH CLIPS



065172

With suture staying frame.

Catalog #	Description
065172	1.5 x 8 mm blades, 1/2" (12.5 mm) bar
065173	1 x 5 mm blades, 7/16" (11 mm) bar

MICRO CLIPS AND APPLIERS

Temporary Vessel Clips

WECK® MICRO VESSEL APPROXIMATORS



065170

Catalog #	Description
065165	1.5 x 7.5 mm blades, 1/2" (12.5 mm) bar
065170	1.5 x 7.5 mm blades, 3/4" (19 mm) bar

ULNAR RADIAL APPROXIMATOR



065190

Catalog #	Description
065190	12 x 12 mm blades, 1" (25.5 mm) bar

MICRO CLIPS AND APPLIERS

Temporary Vessel Clips

BRACHIAL LARGE VESSEL APPROXIMATORS



065195

Catalog #	Description
065195	14 mm uniform blades, 1" (25.5 mm) bar
065196	14 mm tapered blades, 1" (25.5 mm) bar

BRACHIAL LARGE VESSEL CLIPS



065110

Catalog #	Description
065110	24 mm straight blade
065111	24 mm tapered blade

VAN BEEK NERVE APPROXIMATORS



065151

Catalog #	Description
065151	For median ulna nerves, 15 mm blade, 1" (25.5 mm) bar, 28 Ga. needles
065152	10 mm blade, 5/8" (16 mm) bar

VASOVASOSTOMY APPROXIMATOR



065181

Catalog #	Description
065181	12 mm blades with serrated 2 mm cups, 3/4" (19 mm) bar

MICRO CLIPS AND APPLIERS

Temporary Vessel Clips

APPROXIMATION CLAMP



GS44030

Catalog #
GS44030

Description
Without suture holding frame, 1/2" (12.5 mm)

MICRO CLAMP APPLICATOR



GS44028

For Approximation Clamp GS44030.

Catalog #
GS44028

Description
5-1/2" (14 cm)

KLEINERT-KUTZ MICRO CLIP APPLYING FORCEPS



065155

Catalog #
065155

Description
2-1/2" (6.5 cm)

RIZZUTI ANGLED MICRO CLIP APPLYING FORCEPS



065175

Applier opens approximator simultaneously or individually.

Catalog #
065175

Description
5-1/2" (14 cm)

MICRO CLIPS AND APPLIERS

Temporary Vessel Clips

MICHEL SKIN CLIPS



151228

Catalog #
151228

Description
18 mm, nickel silver, package of 100

MICHEL CLIP APPLYING FORCEPS



GS42254

Catalog #
GS42254

Description
5" (12.5 cm)

RICHTER HEATH CLIP FORCEPS



151240

Removing forceps.

Catalog #
151240

Description
5-1/2" (14 cm)

MICHEL CLIP FORCEPS



151210

Applying and removing forceps.

Catalog #
151210

Description
4-3/4" (12 cm)

MICRO CLIPS AND APPLIERS

Temporary Vessel Clips

WACHENFELDT CLIP APPLYING AND REMOVING FORCEPS



GS42256

Catalog #
GS42256
GS42258

Description
5" (12.5 cm)
Cross-action, 5" (12.5 cm)



GS42258

MICRO CLIP TRAY



065199

Catalog #
065199

Description
1-3/4" x 2-3/4" x 1/2" (4.5 x 7 x 1.5 cm)

NEEDLE HOLDERS

NEEDLE HOLDERS

General Needle Holders

BAUMGARTNER NEEDLE HOLDER



Catalog #
152710

Description
11.7 x 2.2 mm jaw, 5-1/4" (13.5 cm), TC

BAUMGARTNER BULLDOG® NEEDLE HOLDER



Catalog #
510181

Description
1.6 mm jaw, 5" (12.5 cm), TC

NEEDLE HOLDERS

General Needle Holders

BROWN NEEDLE HOLDER



055200

Catalog #
055200

Description
Regular, convex jaw with fine oblique serrations,
15 x 2.7 mm, 5" (12.5 cm), stainless steel jaw

CONVERSE NEEDLE HOLDER



443100

Catalog #
443100

Description
Large rings, 14 x 2.3 mm jaw, 5" (12.5 cm),
stainless steel jaw

DERF NEEDLE HOLDERS



055135

Weck® Pattern, bright finish.

Catalog #
055135

Description
10.2 x 2.4 mm jaw, 4-3/4" (12 cm), TC

NEEDLE HOLDERS

General Needle Holders

DERF NEEDLE HOLDERS



Catalog #
152798

. Pattern, satin finish.
Description
7.5 x 1.7 mm jaw, 4-1/2" (11.5 cm), TC

DERF NEEDLE HOLDER STANDARD – STAINLESS STEEL JAW



Catalog #
443120

Description
9.5 x 2 mm jaw, 5" (12.5 cm)

NEEDLE HOLDERS

General Needle Holders

GILLIES NEEDLE HOLDER SCISSORS



Large offset thumb ring.

Catalog #	Description
152496	2.2 mm jaw, 6-1/4" (16 cm), TC

HALSEY NEEDLE HOLDERS



Pattern, satin finish. Stainless steel jaw.

Catalog #	Description
GS41064	Smooth, 2.5 mm jaw, 5" (12.5 cm)
GS41066	Serrated, 2.2 mm jaw, 5-1/4" (13.5 cm)

NEEDLE HOLDERS

General Needle Holders

HALSEY NEEDLE HOLDERS



152802

Catalog #	Description
152802	Smooth, 11.5 x 1.8 mm jaw, 5-1/4" (13.5 cm), TC
152800	Serrated, 11 x 2.2 mm jaw, 5-1/4" (13.5 cm), TC

. Pattern, satin finish.

JOHNSON BULLDOG® NEEDLE HOLDER



510311

Catalog #	Description
510311	9.7 x 2.5 mm, Bulldog®aw, 4-3/4" (12 cm), TC

JOHNSON NEEDLE HOLDER



510312

Catalog #	Description
510312	12 x 2 mm jaw, 4-3/4" (12 cm), TC

NEEDLE HOLDERS

General Needle Holders

NEIVERT NEEDLE HOLDER



Off-set ring handle.

Catalog #	Description
152805	16 x 2 mm jaw, 5-1/4" (13.5 cm), TC

PAR NEEDLE HOLDERS



Catalog #	Description
510335	13 x 2 mm jaw, 5" (12.5 cm), TC
510395	11 x 1.8 mm jaw, 5-1/2" (14 cm), TC

NEEDLE HOLDERS

General Needle Holders

WEBSTER NEEDLE HOLDERS



Catalog #
152808

. Pattern, satin finish.

Description

10.2 x 1.8 mm smooth jaw, 4-1/2" (11.5 cm), TC

WEBSTER NEEDLE HOLDERS



Weck® Pattern, bright finish.

Catalog #
510325

Description

Delicate, smooth, 13 x 2.2 mm jaw,
4-3/4" (12 cm), TC

NEEDLE HOLDERS

General Needle Holders

WEBSTER BULLDOG® NEEDLE HOLDER



510321

Weck® Pattern, bright finish.

Catalog#
510321

Description
Delicate, smooth, 13.5 x 2 mm Bulldog® jaw,
4-3/4" (12 cm), TC

WEBSTER NEEDLE HOLDERS



152448

Catalog#
152448

Description
16 x 2.2 mm smooth stainless steel jaw, 5" (12.5 cm)

NEEDLE HOLDERS

General Needle Holders

WEBSTER NEEDLE HOLDERS



GS41068

Catalog #	Description
GS41068	Smooth, stainless steel jaw, 5" (12.5 cm)

OLSEN-HEGAR NEEDLE HOLDER AND SCISSORS



510440

510441

Weck® Pattern, bright finish.

Catalog #	Description
510440	11 x 3.2 mm jaw, 5-3/4" (14.5 cm), TC
510441	15 x 3.1 mm jaw, 6" (15 cm), stainless steel jaw
510445	11.5 x 3.2 mm jaw, 7" (18 cm), TC

NEEDLE HOLDERS

General Needle Holders

OLSEN-HEGAR NEEDLE HOLDERS



Combination needle holder and suture scissors.
Pattern, satin finish.

Catalog #	Description
GS41424	Delicate, 4-3/4" (12 cm)
GS41428	5" (12.5 cm)
GS41440	Delicate, 4-1/2" (11.5 cm), TC
GS41452	6-1/2" (16.5 cm), TC

RYDER FRENCH EYE NEEDLE HOLDERS



. Pattern, satin finish.

Catalog #	Description
152760	20 x 2 mm jaw, 6" (15 cm), TC
152762	20.5 x 2 mm jaw, 7-1/4" (18.5 cm), TC
152764	20 x 2 mm jaw, 8" (20.5 cm), TC

NEEDLE HOLDERS

General Needle Holders

RYDER BULLDOG® NEEDLE HOLDERS



511132

Weck® Pattern, bright finish. French eye with fine serrations and delicate, tapered, Bulldog® Jaw.

Catalog #	Description
511115	9.5 x 2 mm jaw, 5" (12.5 cm), TC
511130	12 x 2 mm jaw, 6" (15 cm), TC
511132	13 x 1.7 mm jaw, 7" (18 cm), TC
511134	13 x 2 mm jaw, 7-3/4" (19.5 cm), TC
511138	12.5 x 1.8 mm jaw, 10" (25.5 cm), TC

RYDER NEEDLE HOLDERS

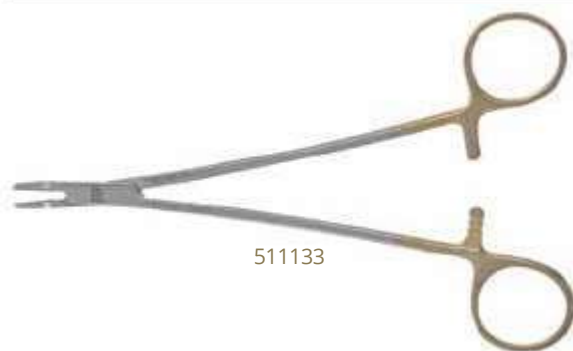

511133

Weck® Pattern, bright finish. French eye with fine serrations and delicate, tapered jaw.

Catalog #	Description
511131	12.5 x 2 mm jaw, 6-1/4" (16 cm), TC
511133	13 x 2.2 mm jaw, 7" (18 cm), TC
511135	12.5 x 1.7 mm jaw, 8" (20.5 cm), TC
511139	12 x 2 mm jaw, 10" (25.5 cm), TC

RYDER EXTRA-FINE TECHNIQUE® NEEDLE HOLDERS



354994

. Pattern, satin finish. Sculptured 1 mm wide jaws designed for the finest vascular, plastic and nerve suture needles. Lightweight throughout (average weight 1 oz).

Catalog #	Description
354990	11.5 x 1.3 mm jaw, 5-1/4" (13.5 cm), TC
354992	12.5 x 1.2 mm jaw, 6" (15 cm), TC
354994	14.3 x 1.2 mm jaw, 7" (18 cm), TC
354996	14.5 x 1.2 mm jaw, 8" (20.5 cm), TC
354998	15 x 1.3 mm jaw, 9" (23 cm), TC

NEEDLE HOLDERS

General Needle Holders

CRILE WOOD NEEDLE HOLDERS



Catalog #	Description
152771	Left-handed, 7" (18 cm), TC
152780	6" (15 cm), TC
152781	Smooth, 6" (15 cm), TC
152782	7" (18 cm), TC
152784	8" (20.5 cm), TC
152786	9" (23 cm), TC
152790	Curved, 7" (18 cm), TC
152792	Curved, 9-1/4" (23.5 cm), TC

. Pattern, satin finish.

CRILE WOOD NEEDLE HOLDERS



Weck® Pattern, bright finish. Delicate, tapered tip.

Catalog #	Description
510400	6" (15 cm), TC
510405	7" (18 cm), TC
510410	8" (20.5 cm), TC
510415	9" (23 cm), TC
510420	10-1/4" (26 cm), TC
510430	12-1/4" (31 cm), TC

NEEDLE HOLDERS

General Needle Holders

CRILE MURRAY BULLDOG® NEEDLE HOLDERS



510241

Weck® Pattern, bright finish. Long, slender Bulldog® Jaw.

Catalog #	Description
510241	15.4 x 1.8 mm jaw, 6-1/4" (16 cm), TC
510251	15.5 x 2.4 mm jaw, 7" (18 cm), TC

CRILE WOOD BULLDOG® NEEDLE HOLDERS



510211

Weck® Pattern, bright finish. Bulldog® Jaw.

Catalog #	Description
510201	Light, 6-1/4" (16 cm), TC
510211	Heavy, 6-1/4" (16 cm), TC

NEEDLE HOLDERS

General Needle Holders

HEGAR BAUMGARTNER NEEDLE HOLDERS



Serrated stainless steel jaw.

Catalog #	Description
GS41162	Serrated, 5" (12.5 cm)
GS41164	Serrated, 5-3/4" (14.5 cm)

MAYO HEGAR NEEDLE HOLDERS



. Pattern, satin finish.

Catalog #	Description
152720	14.5 x 3 mm jaw, 6-1/2" (16.5 cm), TC
152402	23 x 2.8 mm jaw, 7-1/4" (18.5 cm), TC
152722	16.5 x 3.3 mm jaw, 7-1/2" (19 cm), TC
152724	17 x 2.8 mm jaw, 8" (20.5 cm), TC
152406	17 x 2.8 mm jaw, 9-1/4" (23.5 cm), TC
152772	Left-handed, 13 x 2.4 mm jaw, 6-1/4" (16 cm), TC

NEEDLE HOLDERS

General Needle Holders

MAYO HEGAR NEEDLE HOLDERS



Weck® Pattern, bright finish, narrow.

Catalog #	Description
510100	14.6 x 2.6 mm jaw, 6" (15 cm), TC
510110	16.2 x 2.8 mm jaw, 7" (18 cm), TC
510120	15.7 x 3 mm jaw, 8" (20.5 cm), TC
510130	16.4 x 3.2 mm jaw, 9" (23 cm), TC
510140	16.3 x 3.5 mm jaw, 11-3/4" (30 cm), TC

MAYO HEGAR NEEDLE HOLDERS

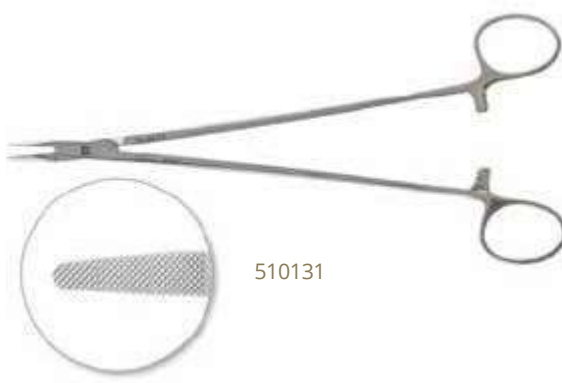

Weck® Pattern, bright finish, Bulldog® Jaw, narrow.

Catalog #	Description
510101	15.5 x 3 mm jaw, 6" (15 cm), TC
510111	16 x 2.8 mm jaw, 7" (18 cm), TC
510121	19 x 2.7 mm jaw, 8" (20.5 cm), TC
510131	20 x 3 mm jaw, 9" (23 cm), TC

NEEDLE HOLDERS

General Needle Holders

MAYO HEGAR NEEDLE HOLDERS



Serrated, stainless steel jaw.

Catalog #	Description
GS41270	5-1/2" (14 cm)
GS41272	6" (15 cm)
GS41278	7" (18 cm)
GS41284	8" (20.5 cm)
GS41286	10-1/2" (26.5 cm)
GS41300	5" (12.5 cm), TC

MAYO HEGAR BROAD BULLDOG® NEEDLE HOLDERS



Weck® Pattern, bright finish, Bulldog® Jaw, broad.

Catalog #	Description
510151	12 x 4 mm jaw, 7" (18 cm), TC
510161	17 x 3.5 mm jaw, 8" (20.5 cm), TC

MASSON BULLDOG® NEEDLE HOLDERS



Catalog #	Description
511101	Heavy, 18.5 x 3 mm jaw, 10-1/4" (26 cm), TC
511102	Light, 18.5 x 3.2 mm jaw, 10-1/4" (26 cm), TC

NEEDLE HOLDERS

General Needle Holders

MASSON NEEDLE HOLDERS

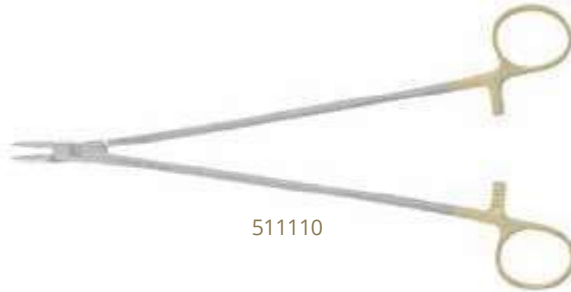

511110

Catalog #	Description
511110	15.5 x 2.4 mm jaw, 7" (18 cm), TC
511112	16 x 3.2 mm jaw, 11-3/4" (30 cm), TC

HEANEY BULLDOG® NEEDLE HOLDER



511251

Catalog #	Description
511251	19.3 x 3.2 mm curved Bulldog® Jaw, 8" (20.5 cm), TC

HEANEY NEEDLE HOLDERS



511250

Catalog #	Description
511250	20.5 x 2.6 mm curved jaw with cross serrations, 8" (20.5 cm), TC

NEEDLE HOLDERS

General Needle Holders

HEANEY NEEDLE HOLDERS



Catalog #
511252

Description
3.2 mm curved jaw, 8" (20.5 cm), serrated
stainless steel jaw

HEANEY NEEDLE HOLDERS



Catalog #
152837

Description
25.6 x 2.5 mm curved jaw, 10-1/2" (26.5 cm), TC

MCALLISTER BULLDOG® NEEDLE HOLDER

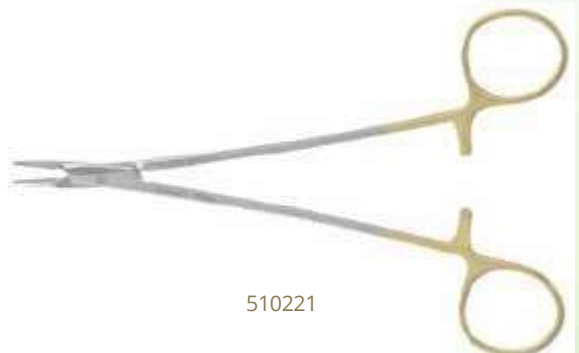

Catalog #
510221

Description
Long, delicate, 14.5 x 1.8 mm, Bulldog® Jaw,
7" (18 cm), TC

NEEDLE HOLDERS

General Needle Holders

SAROT NEEDLE HOLDERS

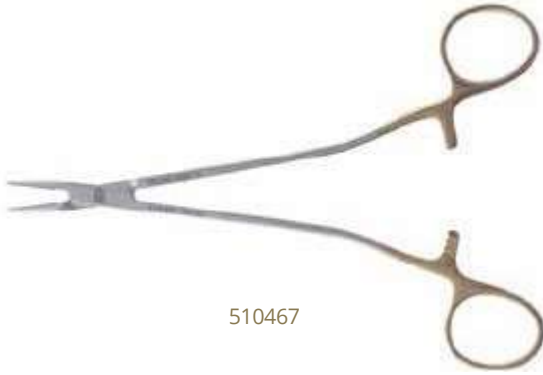

510467

Weck® Pattern, bright finish. Parallel shanks with offset finger rings.

Catalog #	Description
510467	16.5 x 1.8 mm jaw, 7" (18 cm), TC
510469	17 x 1.8 mm jaw, 9" (23 cm), TC

SAROT NEEDLE HOLDER



152796

Catalog #	Description
152796	19.5 x 1.8 mm jaw, 10-1/4" (26 cm), TC

NEEDLE HOLDERS

General Needle Holders

STRATTE NEEDLE HOLDERS



Catalog #
152855
343027

Description
22 x 2.7 mm jaw, 8" (20.5 cm), TC
Reverse curved, 9" (23 cm), TC

CVT-Type Needle Holders

BAILEY CARDIAC TECHNIQUE® NEEDLE HOLDER



Very light construction throughout with fine tapered tips. Jaws are lightly scored for use with smallest size needles and sutures. Tungsten Carbide.

Catalog #
354931

Description
17 x 2 mm jaw, 7" (18 cm), TC

NEEDLE HOLDERS

CVT-Type Needle Holders

DEBAKEY® TECHNIQUE® NEEDLE HOLDERS



Carefully designed with light, short Tungsten Carbide jaws. Constructed in weight proportional to total length. May be purchased individually or as matched set of four.

Catalog#	Description
354900	No. 1. Length, 18.2 x 2 mm jaw, 7" (18 cm), TC
354902	No. 2. Length, 21.5 x 1.8 mm jaw, 9-1/4" (23.5 cm), TC
354904	No. 3. Length, 21.5 x 2.3 mm jaw, 10-1/2" (26.5 cm), TC
354906	No. 4. Length, 19 x 2.6 mm jaw, 11-3/4" (30 cm), TC
354908	Matched set of four, TC

FINOCHIETTO NEEDLE HOLDER



Catalog#	Description
152842	25.5 x 2.5 mm jaw, 10-1/2" (26.5 cm), TC

NEEDLE HOLDERS

CVT-Type Needle Holders

GERBODE TECHNIQUE® NEEDLE HOLDER



Medium-light construction. A strong full-sized needle holder with jaws tapered to 2 mm width for holding fine needles.

Catalog #	Description
343000	16.5 x 2 mm jaw, 10-1/2" (26.5 cm), TC

HOWELL CORONARY TECHNIQUE® NEEDLE HOLDER

Catalog #
354920



Description
14 x 1.6 mm jaw, 7-1/4" (18.5 cm), TC

HOWELL VALVE TECHNIQUE® NEEDLE HOLDER



Catalog #	Description
354928	19 x 2 mm jaw, 8" (20.5 cm), TC

NEEDLE HOLDERS

CVT-Type Needle Holders

JAMISON TECHNIQUE® NEEDLE HOLDER



354941

Long, slender needle holder. Jaws are lightly serrated.

Catalog #	Description
354941	19.8 x 1.8 mm jaw, 9" (23 cm), TC

JULIAN NEEDLE HOLDER



510250

Catalog #	Description
510250	Straight, 21 x 2 mm jaw, 8" (20.5 cm), TC

. EXTRA-LIGHT TECHNIQUE® NEEDLE HOLDERS



354982

Thinner shanks and box-locks than . Thin Needle Holders for reduced weight and more "feel."

Catalog #	Description
354981	17 x 1.8 mm jaw, 6" (15 cm), TC
354982	17.5 x 1.6 mm jaw, 7" (18 cm), TC

NEEDLE HOLDERS

CVT-Type Needle Holders

. INTRACARDIAC TECHNIQUE® NEEDLE HOLDERS



Catalog #	Description
354985	17 x 1.8 mm jaw, 7" (18 cm), TC
354986	11.5 x 1.6 mm jaw, 8" (20.5 cm), TC
354987	20.5 x 2 mm jaw, 9-1/4" (23.5 cm), TC
354988	20.5 x 2 mm jaw, 10-1/4" (26 cm), TC

. THIN VASCULAR AND CORONARY TECHNIQUE® NEEDLE HOLDERS

Delicately proportioned, slender needle holders.



Catalog #	Description
354961	16 x 1.7 mm jaw, 7" (18 cm), TC
354960	16 x 1.8 mm jaw, 6" (15 cm), TC
354962	20 x 1.8 mm jaw, 8-1/4" (21 cm), TC
354958	20.5 x 1.8 mm jaw, 9" (23 cm), TC
354959	20.5 x 2.2 mm jaw, 10-1/4" (26 cm), TC

NEEDLE HOLDERS

CVT-Type Needle Holders

W.M. LEMMON TECHNIQUE® NEEDLE HOLDERS



354916

Catalog #
354915
354916
354917

Description
Delicate, 15.5 x 2.3 mm jaw, 5-3/4" (14.5 cm), TC
14.5 x 1.5 mm jaw, 6-3/4" (17 cm), TC
15.5 x 2.3 mm jaw, 7-1/2" (19 cm), TC

WANGENSTEEN NEEDLE HOLDER



152850

Catalog #
152850

Description
29.4 x 2.3 mm jaw, 10-3/4" (27.5 cm), TC

NEEDLE HOLDERS

Castro-Type Micro Needle Holders

MICRO VASCULAR ROUND HANDLE NEEDLE HOLDERS

	Catalog #	Description
	357654	Straight, without lock, 1.1 mm smooth jaw, 7-3/8" (18.5 cm)
	357655	Curved, without lock, smooth, 7-3/8" (18.5 cm)
	357656	Straight, with lock, 1.2 mm smooth jaw, 7-1/2" (19 cm)
	357657	Curved, with lock, 0.6 mm smooth jaw, 7-3/8" (18.5 cm)
	357667	Straight, with lock, 7-3/8" (18.5 cm), TC
	357672	Straight, with lock, 0.6 mm smooth jaw, 8-1/8" (20.5 cm)
	357675	Straight, with lock, 0.6 mm smooth jaw, 9" (23 cm)
	357676	Curved, with lock, 0.6 mm smooth jaw, 9" (23 cm)
	357677	Straight, with lock, 8" (20.5 cm), TC
	357677	Curved, with lock, 1 mm jaw, 8" (20.5 cm), TC

BARRAQUER MICRO NEEDLE HOLDERS

	Catalog #	Description
	GS44167	Straight, smooth, 5-1/2" (14 cm)
	GS44163	Curved, smooth, 5-1/2" (14 cm)
	GS44169	Straight, smooth, 7" (18 cm)
	GS44165	Curved, smooth, 7" (18 cm)
	GS44168	Straight, smooth, 5-1/2" (14 cm), TC
	GS44164	Curved, smooth, 5-1/2" (14 cm), TC
	GS44157	Straight, serrated, 5-1/2" (14 cm), TC
	GS44155	Curved, serrated, 5-1/2" (14 cm), TC
	GS44170	Straight, smooth, 7" (18 cm), TC
	GS44166	Curved, smooth, 7" (18 cm), TC
	GS44158	Straight, serrated, 7" (18 cm), TC
	GS44156	Curved, serrated, 7" (18 cm), TC

With lock, round handle.

NEEDLE HOLDERS

Castro-Type Micro Needle Holders

CASTROVIEJO NEEDLE HOLDERS



152818

Catalog #	Description
152818	Straight, 11 x 1.4 mm jaw, 6" (15 cm), TC
152819	Curved, 12 x 1.4 mm jaw, 5-3/4" (14.5 cm), TC

MICRO SURGERY NEEDLE HOLDERS



152825

Flat handle, smooth jaws.

Catalog #	Description
152825	Straight, 12.5 x 1.4 mm jaw, 6" (15 cm), TC
152827	Curved, 13 x 1.4 mm jaw, 6" (15 cm), TC

CASTROVIEJO MICRO NEEDLE HOLDERS



GS44204

With lock.

Catalog #	Description
GS44201	Straight, serrated, 5-1/2" (14 cm)
GS44200	Curved, serrated, 5-1/2" (14 cm)
GS44204	Straight, smooth, 7" (18 cm)
GS44202	Curved, smooth, 7" (18 cm)
GS44205	Straight, serrated, 7" (18 cm)
GS44203	Curved, serrated, 7" (18 cm)
GS44208	Straight, serrated, 5-1/2" (14 cm), TC
GS44215	Straight, smooth, 7" (18 cm), TC
GS44214	Curved, smooth, 7" (18 cm), TC
GS44207	Curved, serrated, 7" (18 cm), TC

NEEDLE HOLDERS

Castro-Type Micro Needle Holders

CASTROVIEJO MICRO NEEDLE HOLDERS



GS44219

Without lock.

Catalog #	Description
GS44218	Curved, serrated, 5-1/2" (14 cm)
GS44219	Straight, serrated, 5-1/2" (14 cm)
GS44220	Curved, smooth, 7" (18 cm)
GS44221	Curved, serrated, 7" (18 cm)
GS44222	Straight, smooth, 7" (18 cm)
GS44223	Straight, serrated, 7" (18 cm)

CASTROVIEJO MICRO NEEDLE HOLDERS TC



GS44210

Without lock.

Catalog #	Description
GS44210	Curved, serrated, 5-1/2" (14 cm), TC
GS44211	Curved, serrated, 7" (18 cm), TC
GS44212	Straight, serrated, 5-1/2" (14 cm), TC
GS44213	Straight, serrated, 7" (18 cm), TC
GS44216	Curved, smooth, 7" (18 cm), TC
GS44217	Straight, smooth, 7" (18 cm), TC

CASTROVIEJO MICRO NEEDLE HOLDERS



355559DG

Fine, straight, with round handle and lock. 1 mm Diama-Grip jaws.

Catalog #	Description
355558DG	9" (23 cm)
355559DG	10" (25.5 cm)
355560DG	12" (30.5 cm)

NEEDLE HOLDERS

Castro-Type Micro Needle Holders

CASTROVIEJO MICRO NEEDLE HOLDERS



357676DG

Round handle with Diama-Grip jaws.

Catalog #	Description
357656DG	Straight, with lock, 1.2 mm, 7" (18 cm)
357676DG	Straight, with lock, 1.2 mm, 8" (20.5 cm)
357677DG	Curved without lock, 1 mm, 8" (20.5 cm)

CASTROVIEJO NEEDLE HOLDERS



354964DG

Straight, with flat handle and lock. Diama-Grip jaws.

Catalog #	Description
354964DG	1.8 mm, 7-1/4" (18.5 cm)
354965DG	8" (20.5 cm)

CASTROVIEJO TECHNIQUE® NEEDLE HOLDERS



354964

Catalog #	Description
354964	Straight, 13 x 1.4 mm jaw, 7-1/4" (18.5 cm), TC
354965	Straight, 13 x 1.4 mm jaw, 8" (20.5 cm), TC

NEEDLE HOLDERS

Castro-Type Micro Needle Holders

MICRO SURGERY TECHNIQUE® NEEDLE HOLDERS



354967

Flat handle, smooth jaws.

Catalog #
354966
354967

Description
Straight, 13 x 1.4 mm jaw, 7" (18 cm), TC
Straight, 13 x 1.4 mm jaw, 8" (20.5 cm), TC

SPENCER CORONARY TECHNIQUE® NEEDLE HOLDER



354969

Catalog #
354969

Description
Straight, smooth, 12 x 1.2 mm jaw, 0.9 mm tip,
7" (18 cm), TC

GIANNINI TECHNIQUE® NEEDLE HOLDER



354971

Catalog #
354971

Description
Straight, 17.5 x 1.8 mm jaw, 10-1/4" (26 cm), TC

JACOBSON MICRO NEEDLE HOLDER



357603DG

Catalog #
357603DG

Description
Straight with flat handle, lock, 18 x 1.3 mm
Diam-Grip jaw, 8-1/2" (21.5 cm)

NEEDLE HOLDERS

Castro-Type Micro Needle Holders

JACOBSON MICRO NEEDLE HOLDERS



Catalog #	Description
358001	Straight, round handle, with lock, 11 x 0.8 mm Diamagrip jaw, 9" (23 cm)
358002	Straight, round handle, with lock, 1.8 mm Diamagrip jaw, 9" (23 cm)
358003	Straight, round handle, with lock, 16 x 0.9 mm Diamagrip jaw, 8-1/4" (21 cm)

JACOBSON MICRO-SURGICAL NEEDLE HOLDERS



Castroviejo-type lock can be removed if not required.
Stainless steel jaws.

Catalog #	Description
357601	Straight, flat handle, with lock, 13 x 1.3 mm smooth jaw, 7" (18 cm)
357603	Straight, flat handle, with lock, 13.5 x 1.2 mm smooth jaw, 8-1/2" (21.5 cm)

BARRAQUER MICRO NEEDLE HOLDERS



Without lock, round handle.

Catalog #	Description
GS44175	Straight, smooth, 5-1/2" (14 cm)
GS44171	Curved, smooth, 5-1/2" (14 cm)
GS44177	Straight, smooth, 7" (18 cm)
GS44173	Curved, smooth, 7" (18 cm)
GS44176	Straight, smooth, 5-1/2" (14 cm), TC
GS44172	Curved, smooth, 5-1/2" (14 cm), TC
GS44161	Straight, serrated, 5-1/2" (14 cm), TC
GS44159	Curved, serrated, 5-1/2" (14 cm), TC
GS44178	Straight, smooth, 7" (18 cm), TC
GS44174	Curved, smooth, 7" (18 cm), TC
GS44162	Straight, serrated, 7" (18 cm), TC
GS44160	Curved, serrated, 7" (18 cm), TC

NEEDLE HOLDERS

Castro-Type Micro Needle Holders

BARRAQUER DELICATE NEEDLE HOLDERS

With lock, round handle.



Catalog #	Description
GS44133	Straight, smooth, 5-1/2" (14 cm)
GS44129	Curved, smooth, 5-1/2" (14 cm)
GS44135	Straight, smooth, 7" (18 cm)
GS44131	Curved, smooth, 7" (18 cm)
GS44134	Straight, smooth, 5-1/2" (14 cm), TC
GS44130	Curved, smooth, 5-1/2" (14 cm), TC
GS44123	Straight, serrated, 5-1/2" (14 cm), TC
GS44121	Curved, serrated, 5-1/2" (14 cm), TC
GS44136	Straight, smooth, 7" (18 cm), TC
GS44132	Curved, smooth, 7" (18 cm), TC
GS44124	Straight, serrated, 7" (18 cm), TC
GS44122	Curved, serrated, 7" (18 cm), TC

BARRAQUER DELICATE NEEDLE HOLDERS

Without lock, round handle.



Catalog #	Description
GS44151	Straight, smooth, 5-1/2" (14 cm)
GS44137	Curved, smooth, 5-1/2" (14 cm)
GS44153	Straight, smooth, 7" (18 cm)
GS44139	Curved, smooth, 7" (18 cm)
GS44152	Straight, smooth, 5-1/2" (14 cm), TC
GS44138	Curved, smooth, 5-1/2" (14 cm), TC
GS44127	Straight, serrated, 5-1/2" (14 cm), TC
GS44125	Curved, serrated, 5-1/2" (14 cm), TC
GS44154	Straight, smooth, 7" (18 cm), TC
GS44150	Curved, smooth, 7" (18 cm), TC
GS44128	Straight, serrated, 7" (18 cm), TC
GS44126	Curved, serrated, 7" (18 cm), TC

NEEDLE HOLDERS

Wire Twisters

BAUMGARTEN WIRE TWISTER



Catalog#
142521

Description

Heavy square, 17.5 x 5 mm jaw, 8-1/8" (20.5 cm), TC

RUBIO TECHNIQUE® WIRE TWISTER



Catalog#
351349

Description

12 x 4.5 mm jaw, 5" (12.5 cm), TC

NEEDLE HOLDERS

Wire Twisters

BERRY STERNAL TECHNIQUE® NEEDLE HOLDER



A large, heavy-duty needle holder with 6 mm wide jaws designed to securely hold the large needles used to close sternotomies. LIFE-LOK® Box-Lock.

Catalog #	Description
343030	28 x 6 mm jaw, 7-3/4" (19.5 cm), TC

WIRE FORCEPS



Catalog #	Description
351348	5-3/8" (13.5 cm)

NEEDLE HOLDERS

SutureTags

GREGORY TECHNIQUE® SUTURE "STAY" CLAMPS



Smooth jaw hemostats for tagging sutures. May be used with or without rubber shodding.

Catalog #	Description
351830	Straight, 3-7/8" (10 cm), TC
351831	Curved, 3-7/8" (10 cm), TC

OSTEOTOMES

OSTEOTOMES

Lambotte

ORTHOPEDIC INSTRUMENTS

MINI-LAMBOTTE OSTEOTOMES, STRAIGHT 5"

Straight, without calibration lines, 5" (12.5 cm).



GS46342

Catalog #	Description
GS46336	1/8" (4 mm)
GS46338	1/4" (6 mm)
GS46340	5/16" (8 mm)
GS46342	3/8" (10 mm)
GS46344	1/2" (12 mm)
GS46343	9/16" (14 mm)
GS46345	5/8" (15 mm)
GS46346	11/16" (18 mm)
GS46347	3/4" (19 mm)
GS46335	13/16" (20 mm)



4mm



6mm



8mm



10mm



12mm



15mm

LAMBOTTE-STYLE OSTEOTOMES



051086

Pattern, flat thin blade, 5" (12.5 cm).

Catalog #	Description
051082	2mm
051084	4mm
051086	6mm
051088	8mm
051090	10mm
051092	12mm
051095	15mm

OSTEOTOMES

Lambotte

LAMBOTTE OSTEOTOMES, STRAIGHT 7"

Straight, with calibration lines, 7" (18 cm).



GS46348

Catalog #	Description
GS46348	1/8" (4 mm)
GS46349	3/16" (5 mm)
GS46350	1/4" (6 mm)
GS46358	5/16" (8 mm)
GS46351	3/8" (10 mm)
GS46352	1/2" (12 mm)
GS46353	5/8" (16 mm)
GS46354	3/4" (19 mm)
GS46355	7/8" (22 mm)
GS46356	1" (25 mm)



4mm

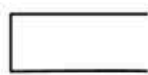

8mm



12mm



25mm

LONG BEVEL OSTEOTOMES

The unusually long bevel allows the cut bone to bend gradually as it is cut. Calibration lines, 7" (18 cm).



GS69940

Catalog #	Description
GS69940	Straight, 10 mm
GS69946	Straight, 20 mm
GS69950	Straight, 25 mm
GS69970	Curved, 5 mm
GS69975	Curved, 10 mm



GS69970



10mm



20mm

OSTEOTOMES

Lambotte

ORTHOPEDIC INSTRUMENTS

LAMBOTTE OSTEOTOMES, STRAIGHT 9"



GS46310

Straight, without calibration lines, 9" (23 cm).

Catalog #	Description
GS46304	1/4" (6 mm)
GS46306	1/2" (13 mm)
GS46310	3/4" (19 mm)
GS46314	1" (25 mm)
GS46318	1-1/4" (32 mm)
GS46322	1-1/2" (38 mm)



6mm

12mm

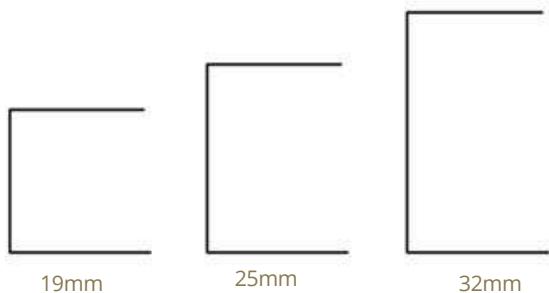

19mm

25mm

32mm

LAMBOTTE OSTEOTOMES, CURVED 9"



GS46330

Curved, without calibration lines, 9" (23 cm).

Catalog #	Description
GS46328	1/4" (6 mm)
GS46329	1/2" (12 mm)
GS46330	3/4" (19 mm)
GS46331	1" (25 mm)
GS46332	1-1/4" (32 mm)
GS46333	1-1/2" (38 mm)

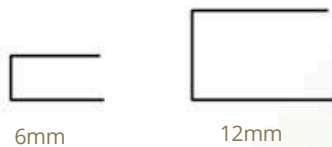

6mm

12mm

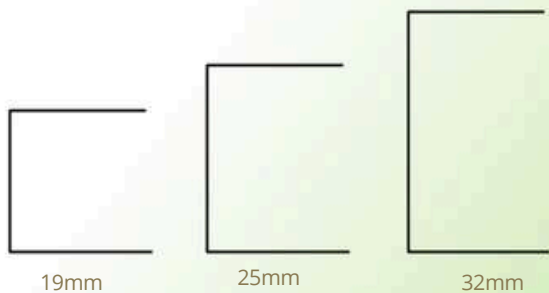

19mm

25mm

32mm

OSTEOTOMES

Specialty

OSTEOTOMES



051104

Flat thin blade, 6" (15 cm).

Catalog #	Description
051102	2mm
051103	3mm
051104	4mm
051105	5mm
051106	6mm
051107	7mm
051110	10mm

MINI OSTEOTOMES



441208

Curved, 5" (12.5 cm).

Catalog #	Description
441207	4mm
441208	6mm

Hoke

HOKE OSTEOTOMES



GS46499

5-1/4" (13.5 cm).

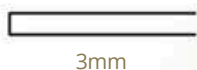
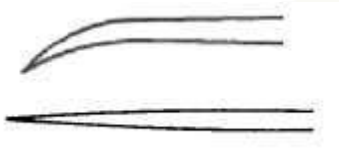

3mm

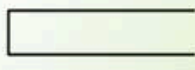

6mm

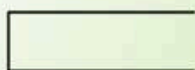

8mm

Catalog #	tip	tip Width
GS46497	Straight	1/8" (3 mm)
GS46498	Straight	3/16" (4 mm)
GS46499	Straight	1/4" (6 mm)
GS46500	Straight	5/16" (8 mm)
GS46501	Straight	3/8" (10 mm)
GS46502	Straight	1/2" (13 mm)
GS46503	Straight	5/8" (16 mm)
GS46504	Straight	3/4" (19 mm)
GS46700	Curved	1/8" (3 mm)
GS46701	Curved	3/16" (4 mm)
GS46702	Curved	1/4" (6 mm)
GS46703	Curved	5/16" (8 mm)
GS46704	Curved	3/8" (10 mm)
GS46706	Curved	1/2" (13 mm)
GS46708	Curved	5/8" (16 mm)
GS46709	Curved	3/4" (19 mm)

OSTEOTOMES

Sheehan

ORTHOPEDIC INSTRUMENTS

SHEEHAN OSTEOTOMES



Straight, 6-1/4" (16 cm).

GS46274

Catalog #	Description
GS46268	2mm
GS46270	4mm
GS46272	6mm
GS46274	8mm
GS46276	10mm
GS46278	12mm
GS46280	15mm



4mm



8mm



12mm

Silver

SILVER OSTEOTOMES



GS58100

Single guard, 7" (18 cm).

Catalog #	Description
GS58100	Straight
GS58102	Guard, right
GS58104	Guard, left

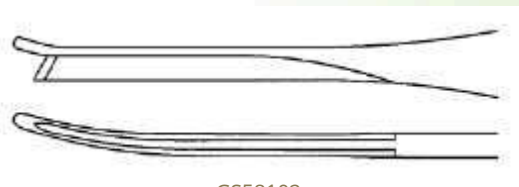

GS58102

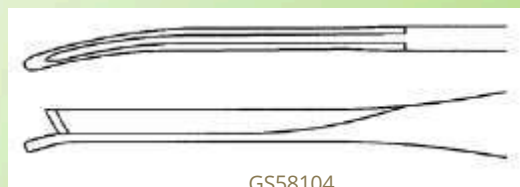

GS58104

OSTEOTOMES

U.S. Army

U.S. ARMY PATTERN OSTEOTOMES



GS46286

7" (18 cm).

Catalog #	Description
GS46284	6mm
GS46286	12mm
GS46288	18mm

Stille

STILLE OSTEOTOMES

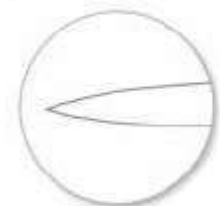

GS49002

Straight, 8" (20.5 cm).

Catalog #	Description
GS49002	10mm
GS49004	14mm
GS49006	18mm
GS49008	22mm

OSTEOTOMES

Hibbs

ORTHOPEDIC INSTRUMENTS

HIBBS OSTEOTOMES



GS46363

GS46379

9" (23 cm).

Catalog #	tip	tip Width
GS46359	Straight	1/4"
GS46360	Straight	3/8"
GS46361	Straight	1/2"
GS46362	Straight	5/8"
GS46363	Straight	3/4"
GS46364	Straight	7/8"
GS46365	Straight	1"
GS46366	Straight	1-1/8"
GS46367	Straight	1-1/4"
GS46368	Straight	1-1/2"
GS46373	Curved	1/4"
GS46376	Curved	3/8"
GS46377	Curved	1/2"
GS46378	Curved	5/8"
GS46379	Curved	3/4"
GS46380	Curved	7/8"
GS46381	Curved	1"
GS46382	Curved	1-1/8"
GS46383	Curved	1-1/4"
GS46384	Curved	1-1/2"

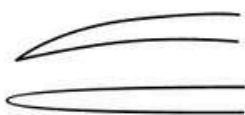

1"



1-1/4"

HIBBS ENDOSCOPIC OSTEOTOME



Straight tip, 18-1/2" (47 cm).

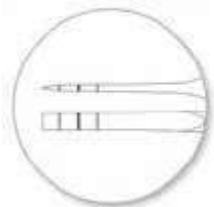

GS55642

Catalog #	tip Width	tip length	shaft length	shaft Diameter	hanDle length
GS55642	3/8" (10 mm)	3-1/2"	10-3/4"	0.43" (11 mm)	4-1/4"

OSTEOTOMES

Interchangeable Osteotome, Chisel and Gouge Set

ORTHOPEDIC INSTRUMENTS

INTERCHANGEABLE OSTEOTOME, CHISEL AND GOUGE SET



Catalog #	Description
GS49630	Complete set with handle, key and all blades
GS49632	Phenolic handpiece only, 7-3/8" (18.5 cm)
GS49634	Key only
GS49668	Osteotome blade, 5 mm
GS49672	Osteotome blade, 10 mm
GS49676	Osteotome blade, 16 mm
GS49680	Osteotome blade, 25 mm
GS49652	Chisel blade, 5 mm
GS49656	Chisel blade, 10 mm
GS49660	Chisel blade, 16 mm
GS49664	Chisel blade, 25 mm
GS49640	Gouge blade, 1" wide, 50 mm radius
GS49644	Gouge blade, 1" wide, 60 mm radius
GS49648	Gouge blade, 1" wide, 70 mm radius



GS49630

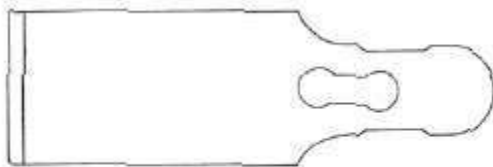

GS49664

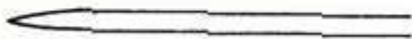
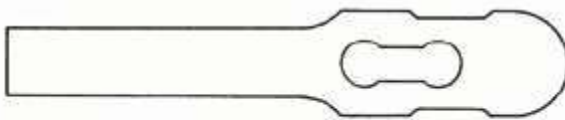

GS49672

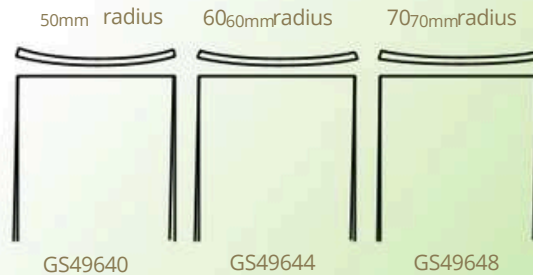

GS49640

GS49644

GS49648

Blades should be discarded after use.
Phenolic handle is autoclavable to 290° F (143° C).

SR 49640 CU, Old

RECTAL

RECTAL

Forceps and Clamps

BARRON HEMORRHOIDAL ALLIGATOR SEIZING FORCEPS



Catalog #
202970

Description
5 x 6 teeth, 11-3/4" (30 cm)

BUIE PILE CLAMP

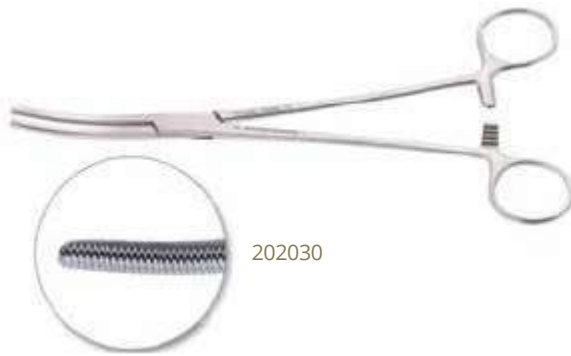

Angiotribe jaws.

Catalog #
202030

Description
Curved, serrated, 5/8" (16 mm) tip length,
8-7/8" (22.5 cm)

RECTAL

Forceps and Clamps

MCGIVNEY FORCEPS



GS63503

Catalog #
GS63503

Description
Angled shanks, 7-1/2" (19 cm)

PRATT "T" FORCEPS



477115

Concave, T-shaped jaws, with serrations.

Catalog #
477115

Description
6" (15 cm)

RECTAL BIOPSY FORCEPS



203142

Catalog #
203142

Description
Oval, basket punch type, 13.5 x 4 mm jaw,
14-1/2" (37 cm)

RECTAL

Forceps and Clamps

ROTATING RECTAL BIOPSY FORCEPS



204004

Positive, universal handle. Curved upper jaw and serrated lower jaw give firm grasp and clean cut of tissue. Stems are rotatable full 360 degrees. Stainless steel.

Catalog #	Description
204004	10" (25.5 cm) stem only, straight jaw
204016	13-7/8" (35 cm) stem only, angular jaw
204018	Handle only



204016



204018

RECTAL

Retractors and Specula

HILL FERGUSON RECTAL RETRACTORS



730296

Catalog#
730295
730296

Description
Blade 2-3/8" x 1" (6 x 2.5 cm), 8-1/2" (21.5 cm)
Blade 2-3/4" x 1-1/8" (7 x 3 cm), 9-1/2" (24 cm)

SAWYER RECTAL RETRACTORS



202151

Catalog#
202150
202151

Description
Small, blades 2-1/2" x 7/8" (6.5 x 2 cm),
10-5/8" (27 cm)
Medium, blades 3" x 1-1/8" (7.5 x 3 cm), 11" (28 cm)

SMITH RECTAL RETRACTOR



202140

Catalog#
202140

Description
Blade 2-13/16" (7 cm), 8-7/8" (22.5 cm) spread

RECTAL

Retractors and Specula

BODENHAMMER RECTAL SPECULUM



GS63300

Catalog #
GS63300Description
Set screw, solid blades, 6" (15 cm)

BRINKERHOFF RECTAL SPECULA



GS63354

Catalog #
GS63350
GS63352
GS63354Description
Small
Medium
Large

RECTAL

Retractors and Specula

FANSLER OPERATING SPECULUM



202105

Catalog #
202105Description
Slotted tube 2-3/8" (6 cm) long, 1-1/4" (3 cm)

FANSLER-IVES RECTAL SPECULA



GS63319

Catalog #
GS63318
GS63319Description
Chrome speculum with obturator
Rubber obturator only

RECTAL

Retractors and Specula

PRATT RECTAL SPECULA



Catalog #	Description
202060	Large, blades 3-3/8" (8.5 cm) long, 1" (2.5 cm) diameter
202062	Small, blades 3-1/2" (9 cm) long, 3/4" (2 cm) diameter

SIMS RECTAL SPECULUM



Catalog #	Description
202067	Fenestrated blades 3-1/2" (9 cm) long, 3/4" (2 cm) diameter

RECTAL

Retractors and Specula

HIRSCHMAN ANOSCOPES



202095

Catalog #
202095
202096
202097

Description
Small, 5/8" (16 mm) tip diameter, 2-1/2" (6.5 cm)
Medium, 3/4" (19 mm) tip diameter, 2-3/4" (7 cm)
Large, 7/8" (22 mm) tip diameter, 2-3/4" (7 cm)

Miscellaneous

BARR CRYPT HOOK



202623

Catalog #
202623

Description
Double-ended, 10-1/8" (25.5 cm)

MARTIN RECTAL HOOK



732101

Catalog #
732101

Description
Hook 9 x 2 mm, 7" (18 cm)

RECTAL

Miscellaneous

PRATT CRYPT HOOK



202635

Catalog #
202635Description
Small hook, 8-7/8" (22.5 cm)

STEWART RECTAL HOOK

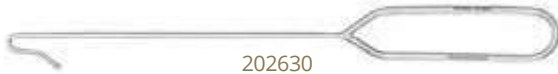

202630

Catalog #
202630Description
7/8" (22 mm) hook, 8-7/8" (22.5 cm)

BUIE SUCTION TUBES



202792

Distal and side openings.

Catalog #
202792Description
Thumb valve control model, 15 Fr. diameter,
17" (43 cm)

LARRY PROBE AND GROOVE DIRECTOR



202600

Catalog #
202600Description
5-7/8" (15 cm)

SCREWDRIVERS

SCREWDRIVERS

Hex Head

ORTHOPEDIC INSTRUMENTS

HEXAGONAL SCREWDRIVERS



GS47952



GS48349

CATALOG #	Description
GS47952	2.5 mm screwdriver with sleeve, 7-7/8" (20 cm)
GS48368	2.5 mm screwdriver with notch, 8-1/4" (21 cm)
GS48349	3.5 mm screwdriver with notch, 9-5/8" (24.5 cm)
GS47955	Screw holding sleeve only for GS47952, 2" (5 cm)
GS48365	Screw holding sleeve only for GS48368, 3" (8 cm)
GS47983	Screw holding sleeve only for GS48349, 5" (12.5 cm)
GS47956	Screwdriver only for GS47952

Autoclavable to 290°F (143°C)

HEXAGONAL SCREWDRIVER SHAFT (PELVIC)



GS47951



GS47961



GS48365

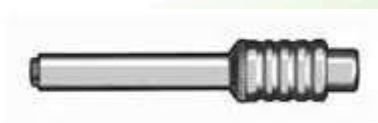

GS47983

CATALOG #	Description
GS47951	2.5 mm with notch, quick coupling end, 6-1/2" (16.5cm)
GS47953	2.5 mm without notch, quick coupling end, 4" (10cm)
GS47961	3.5 mm with notch, quick coupling end, 6-1/2" (16.5 cm)
GS48365	Sleeve only for GS47951, 3" (8 cm)
GS47983	Sleeve only for GS47961, 5" (12.5 cm)

SCREWDRIVERS

Hex Head

SCREWDRIVER SLEEVES



GS48365

CATALOG #	Description
GS48365	Sleeve only for GS47951, GS48348, GS48364, GS48368, 3" (8 cm)
GS47983	Sleeve only for GS48349, GS48353 and GS47961, 5" (12.5 cm)

LARGE HEXAGONAL SCREWDRIVER (PELVIC)

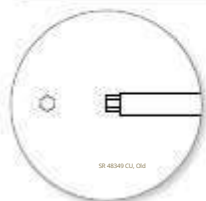

GS48353

CATALOG #	Description
GS48353	3.5 mm screwdriver with notch, 11-3/4" (30 cm)
GS48364	Screwdriver only, 2.5 mm with notch, 11" (27 cm)
GS47983	Sleeve only for GS48353, 5" (12.5 cm)

Autoclavable to 290°F (143°C)

LARGE HEX SCREWDRIVER WITH UNIVERSAL JOINT



GS48396

CATALOG #	Description
GS48396	3.5 mm tip, 11-5/8" (29.5 cm)

LARGE HEXAGONAL SCREWDRIVER



GS47954

CATALOG #	Description
GS47954	3.5 mm, quick coupling end, 3-7/8" (10 cm)

SCREWDRIVERS

Hex Head

MINI HEXAGONAL SCREWDRIVER



CATALOG #	Description
GS47950	1.5 mm, mini quick coupling end, sleeve included, 2-1/4" (5.5 cm)
GS47950B	Shaft only, 1.5 mm with notch, mini quick coupling end, 2" (5 cm)
GS47959	Screw holding sleeve only

HEXAGONAL SCREWDRIVER SHAFT



CATALOG #	Description
GS48348	2.5 mm with notch, quick coupling end, 5-1/2" (14 cm)
GS48365	Sleeve only

SCREWDRIVERS

Hex Head

SCREWDRIVER



CATALOG #	Description
GS48670	1.5 mm hexagonal, 7-7/16" (200 mm)
GS48350	2.5 mm hexagonal, 9-27/32" (250 mm)
GS48352	3.5 mm hexagonal, 9-27/32" (250 mm)
GS48354	Single slot, 9-27/32" (250 mm)
GS48356	Cruciform, 9-27/32" (250 mm)
GS48358	Phillips, 9-27/32" (250 mm)

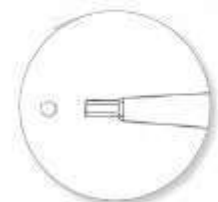

GS48350

Autoclavable to 290°F (143°C)

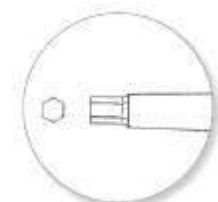

GS48352

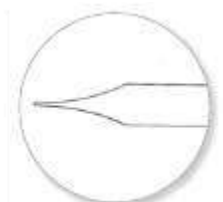

GS48354

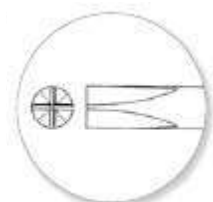

GS48356

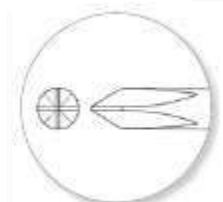

GS48358

SINGLE SLOT SCREWDRIVER



CATALOG #	Description
GS48355	Phenolic handle, 6-3/4" (17 cm)



GS48355

SCREWDRIVERS

Cruciform Head

ORTHOPEDIC INSTRUMENTS

CRUCIFORM SCREWDRIVER



CATALOG #	Description
GS47957	1.5 / 2.0 mm screwdriver with sleeve, 7-1/2" (19 cm)
GS47959	Screw holding sleeve only for GS47957
GS47958	Screwdriver only for GS47957

Autoclavable to 290°F (143°C)

MINI CRUCIFORM SCREWDRIVER BIT



CATALOG #	Description
GS45004	1.5 / 2 mm, mini quick coupling end, 2-1/2" (6.5 cm)

SCREW DRIVERS

T-Handle

LARGE HEX SCREWDRIVER W/ T-HANDLE

CATALOG #	Description
GS48395	3.5 mm, quick coupling end, 6-7/8" (17.5 cm)

Depth Gauge

SCREW DEPTH GAUGES



GS47934

Used to determine screw length required during internal fracture fixation (mm graduated). Snaps apart for easy cleaning. **IMPORTANT NOTE:** When not in use, retract measuring end inside gauge for probe protection.

CATALOG #	Description
GS47934	Mini, up to 30 mm, 4-3/4" (12 cm)
GS47936	Small, up to 50 mm, 6-1/4" (16 cm)
GS47940	Large, up to 100 mm, 8-3/4" (22 cm)
GS47935	Extra-long, up to 120 mm, 11" (28 cm)

SCREWDRIVERS

Screwdriver Sets

ORTHOPEDIC INSTRUMENTS

INTERCHANGEABLE SCREWDRIVER SET



GS48473



GS48474



GS48475



GS48476



GS48477

CATALOG #

GS48473

GS48474

GS48475

GS48476

GS48477

GS48478

GS48478P

GS48479

GS48480

Description

Screwdriver handle. Allows K-Wire and pins to be inserted with Jacobs Universal Chuck GS48478.

Cannulation 1/4" (6.3 mm), includes key, 5-1/2" (14 cm)

Single slot, 5-1/2" (14 cm)

Cruciform, 5-1/2" (14 cm)

Phillips, 5-1/2" (14 cm)

Small Phillips, 5-1/2" (14 cm)

Jacobs Universal Chuck. Allows K-Wire and pins to be inserted with Jacobs Chuck. Cannulation 1/4" (6.3 mm), includes key, 3" (7.5 cm)

Key for GS48478 Jacobs Universal Chuck

3.5 mm diameter, 5-1/2" (14 cm)

2.5 mm diameter, 5-1/2" (14 cm)



GS48478



GS48479



GS48480

SCREW WDRIVERS

Screw Holding Forceps

SELF-RETAINING SCREW HOLDING FORCEPS



GS47930

CATALOG #
GS47930

Description
3-1/2" (9 cm)

SELF-RETAINING SCREW HOLDING FORCEPS



GS45210

CATALOG #
GS45208
GS45210

Description
For 1.5 mm to 2.7 mm screws
For 3.5 mm to 6.5 mm screws

SPECIALTY SETS

SPECIALTY SETS

Micro Vascular Set

MICROVASCULARSETOF11INSTRUMENTS



357651



357652



357653



357654



357655



357656



Catalog #

357650

429594

357651

357652

357653

357654

357655

357656

357657

357658

357659

357660

357661

Description

Tray and Set

Tray only 8" (20.5 cm) x 12 1/2" (31.5 cm)

Micro Scissors, straight, 12 mm blades, 7-3/8" (19 cm)

Micro Scissors, curved, 12 mm blades, 7-1/4" (18.5 cm)

You-Potts Scissors, angled 45 degrees, 12 mm blades, 7-3/8" (18.5 cm)

Micro Needle Holder, straight, no lock, 1.15 mm jaw, 7-3/8" (18.5 cm)

Micro Needle Holder, curved, no lock, 7-3/8" (18.5 cm)

Micro Needle Holder, straight, lock, 1.2 mm jaw, 7-1/2" (19 cm)

Micro Needle Holder, curved, no lock, 0.6 mm jaw, 7-3/8" (18.5 cm)

Micro Tying Forceps, round handle 8 mm diameter, straight 0.5 mm wide tip with platform, 6" (15 cm)

Micro Tying Forceps, round handle 8 mm diameter, curved 0.5 mm wide tip with platform, 6" (15 cm)

Micro Tying Forceps, round handle 8 mm diameter, straight 0.5 cm wide tip with platform, 7-1/8" (18 cm)

Micro Tying Forceps, round handle 8 mm diameter, curved 0.5 mm wide tip with platform, 7-1/8" (18 cm)



357657



357658

SPECIALTY SETS

Micro Vascular Set

MICRO VASCULAR SET OF 11 INSTRUMENTS



357659



357660



357661



357650



429594

SPECIALTY SETS

Vascular Access Set

THE VASCULAR ACCESS SET



355600

COMPLETE SET:

355600 W.G.H. Vascular Access Set

complete with stainless steel storage case

341010 Stainless steel case for Vascular Access Set

Designed for all Angle Access procedures — not just AV. fistula — a logically planned set of instruments suited for:

- End-to-end, end-to-side, AV. fistula — any extremity
- Fistulas with graft
- External shunts



341010

SPECIALTY SETS

Vascular Access Set

Vascular Access Sets suited for:



Brescia AV. fistula side to side

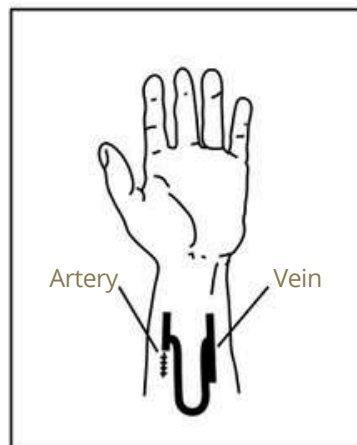

AV. fistula with external shunt

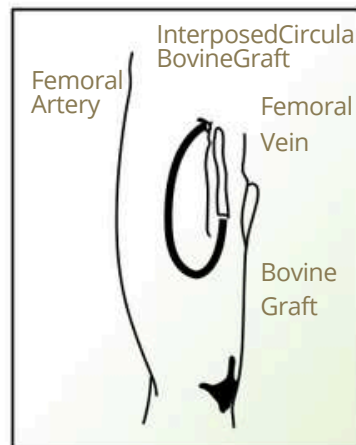

AV. fistula with graft

All instruments are supplied in a stainless steel storage case for protection and easy instrument counts.

SPECIALTY SETS

Vascular Access Set

THE VASCULAR ACCESS SET



Catalog #	Description
353187	Gregory Mini-vascular Clamps, curved, extra-light, 4-1/8" (10.5 cm)
353190	Gregory Mini-vascular Clamps, angled 45 degrees, extra-light, 4-3/8" (11 cm)
165439	Two of the Short Model Gelpi, sharp prongs, 3-1/8" (8 cm) spread, 5-3/8" (13.5 cm)
355275	Hiebert Vascular Dilators, 0.5 mm x 1 mm
355276	Hiebert Vascular Dilators, 1.5 mm x 2 mm
355277	Hiebert Vascular Dilators, 2.5 mm x 3 mm
355278	Hiebert Vascular Dilators, 3.5 mm x 4 mm
152818	Castroviejo Needle Holder, straight, 11 x 1.4 mm jaw, 6" (15 cm), TC
354964	Castroviejo Needle Holder, straight, 13 x 1.4 mm jaw, 7-1/4" (18.5 cm), TC

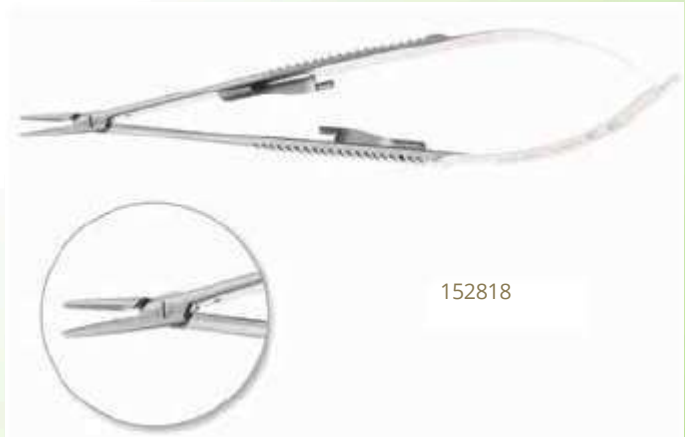

152818



354964

SPECIALTY SETS

Vascular Access Set

THE VASCULAR ACCESS SET (CONTINUED)



352145

Catalog #

352145

Description

Potts-Type Scissors, angled 45 degrees, 9 mm blades, 4-1/8" (10.5 cm)

353600

DeBakey® Aortic Aneurysm Clamp, 3-3/4" (9.5 cm) jaw, 1 x 9 ratchets, 10-3/8" (26.5 cm)

353011

Three of the Johns Hopkins Bulldog® Clamps, curved jaws, 1-1/2" (4 cm)

351830

Gregory Suture "Stay" Clamps, straight, 3-7/8" (10 cm), TC

351575

DeBakey® Heparin Cannula, malleable, 3 mm tip, 2-1/2" (6.5 cm)

351825

Wheeler Pick-up Forceps, DeBakey®-type jaw, 1.6 mm, 5-1/2" (14 cm)

351827

Wheeler Pick-up Forceps, DeBakey®-type jaw, 1.6 mm, 7-1/8" (18 cm)



353600



351830



351575



351827

SUCTION TUBES

SUCTION TUBES

General

FRAZIER SUCTION TUBES

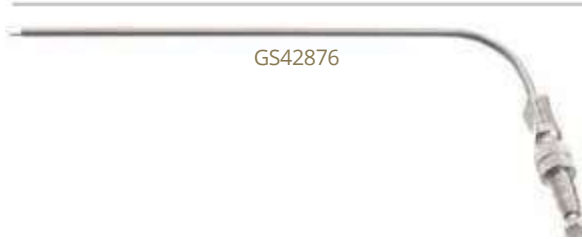

Pattern, satin finish.

Catalog #	Description
GS42863	7 Fr. tip, 4-1/2" (11.5 cm)
GS42864	9 Fr. tip, 4-1/2" (11.5 cm)
GS42866	11 Fr. tip, 4-1/2" (11.5 cm)
GS42873	7 Fr. tip, 7-1/2" (19 cm)
GS42874	9 Fr. tip, 7-1/2" (19 cm)
GS42876	11 Fr. tip, 7-1/2" (19 cm)

PEDIATRIC POOLE SUCTION TUBE



Catalog #	Description
536107	16 Fr., 6 mm tip, 7-1/2" (19 cm)

POOLE ABDOMINAL SUCTION TUBES



Removable inner tube in multi-perforated outer tube.

Catalog #	Description
162210	Large, 30 Fr., straight connector, 9-1/4" (23.5 cm)
162212	Small, 23 Fr., curved connector, 10-1/4" (26 cm)

YANKAUER SUCTION TUBES



Catalog #	Description
162300	Standard adult size, 10 mm diameter. Tip has 2 mm central opening and four 2 mm, side openings. Length 11-1/2" (29 cm)
162301	Tip only for 162300 Yankauer, 1/2" (12.5 mm)



SUCTION TUBES

General

YANKAUER SUCTION TUBE WITH SWITCH VALVE



162345

For use with wall suction. Stopcock-type valve allows reliable "on-off" action. Tube is detachable for cleaning.

Catalog #	Description
162345	11-3/4" (30 cm)

Specialty

BARON SUCTION TUBES



411702

With finger cut-off.

Catalog #	Description
411700	3 Fr. tip
411702	5 Fr. tip
411704	7 Fr. tip

ROSEN SUCTION TUBES

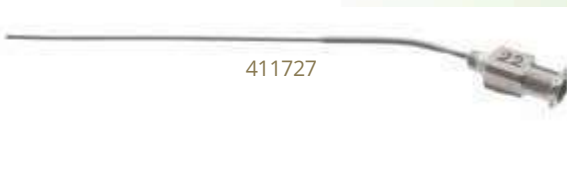

411727

Catalog #	Description
411724	18 Ga. tip, 3-3/4" (9.5 cm)
411726	20 Ga. tip, 3-3/4" (9.5 cm)
411727	22 Ga. tip, 3-3/4" (9.5 cm)
411728	24 Ga. tip, 3-3/4" (9.5 cm)

SUCTION TUBES

Specialty

FUKUSHIMA SUCTION TUBES



Teardrop opening allows surgeon to regulate force of suction.

Catalog #	Description
GS42880	4 Fr. tip, 6-1/4" (16 cm)
GS42881	5 Fr. tip, 6-1/4" (16 cm)
GS42882	6 Fr. tip, 6-1/4" (16 cm)
GS42883	7 Fr. tip, 6-1/4" (16 cm)
GS42884	8 Fr. tip, 6-1/4" (16 cm)
GS42885	9 Fr. tip, 6-1/4" (16 cm)
GS42890	4 Fr. tip, 7" (18 cm)
GS42891	5 Fr. tip, 7" (18 cm)
GS42892	6 Fr. tip, 7" (18 cm)
GS42893	7 Fr. tip, 7" (18 cm)
GS42894	8 Fr. tip, 7" (18 cm)
GS42895	9 Fr. tip, 7" (18 cm)
GS42901	4 Fr. tip, 8" (20.5 cm)
GS42902	5 Fr. tip, 8" (20.5 cm)
GS42903	6 Fr. tip, 8" (20.5 cm)
GS42904	7 Fr. tip, 8" (20.5 cm)
GS42905	8 Fr. tip, 8" (20.5 cm)
GS42906	9 Fr. tip, 8" (20.5 cm)

ANDREWS INFANT SUCTION TUBE



6 mm diameter tip, permanently attached.

Catalog #	Description
162310	9-1/4" (23.5 cm)

ANDREWS PYNCHON SUCTION TUBE



Catalog #	Description
536220	Curved, 6 mm tip, 3 mm diameter removable shaft, 9-5/8" (24.5 cm)

SUCTION TUBES

Specialty

COOLEY SUMP SUCTION TUBE



351547

Long, removable perforated outer tube with internal extension provides for fluid removal by sump-drain principle. Entire tube removable from handle for cleaning and rotatable for convenience.

Catalog #	Description
351547	Curved, 9 mm tip, 12-7/8" (32.5 cm)

DEBAKEY® FIBEROPTIC ILLUMINATED SUCTION TUBE



351508

A modification of the DeBakey®-Yankauer Tube but with a special tip to provide for greater volume of aspirated fluids. Large distal central opening is surrounded by circular perforations and slots in the sides.

Catalog #	Description
351508	9.5 mm tip, 11-3/8" (29 cm)

DEBAKEY® SUCTION TUBES



351500

Catalog #	Description
351500	9.5 mm tip, 11-3/8" (29 cm)
351501	DeBakey® Suction Tube Tip for 351500, 3/8" (9.5 mm)



351501

SUCTION TUBES

Specialty

DEBAKEY® SUCTION TUBE



351502

Distal opening with four side openings 3 mm long, 4 mm diameter.

Catalog #	Description
351502	3 mm diameter tip, 12-1/4" (31 cm)

DEBAKEY®-ADSON CORONARY SUCTION TUBES

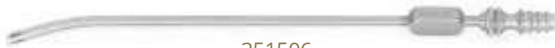

351506

Distal opening with four side openings 3 mm long, 4 mm diameter.

Catalog #	Description
351504	6-1/8" (15.5 cm)
351506	8-1/8" (20.5 cm)

MORSE-ANDREWS SUCTION TUBE



351505

Short length, small 3 mm outside diameter tube, terminating in 6 mm diameter tip which has one distal and four side openings. Handle is ebonized.

Catalog #	Description
351505	10-1/4" (26 cm)

SUCTION TUBES

General

ADSON SUCTION TUBES



See "Scales and Gauges" chart in the beginning of the catalog for French size/mm conversion.

Catalog #	Description
536103	Straight suction with finger valve, 4 mm tip, 8-1/4" (21 cm)

ADSON SUCTION TUBES, CURVED



Curved suction with finger valve. See "Scales and Gauges" chart in the beginning of the catalog for French size/mm conversion.

Catalog #	Description
536100	7 mm, 7-1/4" (18.5 cm)
536104	6 mm, 8-1/4" (21 cm)
536105	5 mm, 6-1/2" (16.5 cm)

FERGUSON-FRAZIER SUCTION TUBES



Stainless steel tubes, block-type finger valve, complete with cleaning stylette. Angled. 4-7/8" (12.5 cm). Pattern, satin finish.

Catalog #	Description
162410	# 0, 6 Fr. tip
162411	# 1, 7 Fr. tip
162412	# 2, 8 Fr. tip
162413	# 3, 9 Fr. tip
162414	# 4, 10 Fr. tip
162415	# 5, 12 Fr. tip
162416	# 6, 14 Fr. tip
162421	Ferguson Stylet # 0

FRAZIER SUCTION TUBES



7" (18 cm). 1 Fr. = .33 mm. Pattern, satin finish.

Catalog #	Description
GS42823	6 Fr. tip
GS42824	7 Fr. tip
GS42825	8 Fr. tip
GS42826	10 Fr. tip
GS42830	12 Fr. tip
GS42825P	Frazier Stylet 8 Fr.

WIRE AND PIN IMPLANTS

STEINMANN PINS (SMOOTH) — PKG/6							
LENGTH	5/64" (2.0 mm)	3/32" (2.4 mm)	7/64" (2.8 mm)	1/8" (3.2 mm)	9/64" (3.5 mm)	5/32" (4.0 mm)	0.177" (4.5 mm)
DOUBLE-END TROCAR 							
4"	—	—	—	—	—	—	—
5"	—	—	—	—	—	—	—
6"	—	—	—	—	—	—	—
9"	GS71450	GS71453	GS71456	GS71459	GS71462	GS71465	GS71468
12"	—	—	—	—	—	—	—
SINGLE TROCAR (ROUND END) 							
4"	—	—	—	—	—	—	—
5"	—	GS71432	—	—	—	—	—
6"	—	—	—	—	—	—	—
7"	—	—	—	GS71434	—	—	—
9"	GS71510	GS71513	GS71516	GS71519	GS71522	GS71525	GS71528
12"	GS71674	GS71676	GS71677	GS71680	GS71681	GS71682	GS71683
DOUBLE-END DIAMOND 							
4"	—	—	—	—	—	—	—
5"	—	—	—	—	—	—	—
6"	—	—	—	—	—	—	—
9"	GS71600	GS71603	GS71606	GS71609	GS71612	GS71615	GS71618
SINGLE DIAMOND (ROUND END) 							
4"	—	—	—	—	—	—	—
9"	GS71660	GS71663	GS71666	GS71669	GS71672	GS71675	GS71678
12"	—	—	—	—	—	—	—
SUTURE PASSER SINGLE DIAMOND WITH SUTURE HOLE (ROUND END) 							
9"	—	—	—	—	—	—	—
SUTURE PASSER SINGLE DIAMOND WITH SUTURE HOLE (3 SHANK END) 							
9"	GS71880	GS71883	GS71886	GS71889	GS71892	GS71895	GS71898
SINGLE TROCAR (3 SHANK END) 							
9"	GS71480	GS71483	GS71486	GS71489	GS71492	GS71495	GS71498
SINGLE DIAMOND (3 SHANK END) 							
9"	GS71630	GS71633	GS71636	GS71639	GS71642	GS71645	GS71648
STEINMANN PINS (FULLY THREADED) — PKG/6							
LENGTH	5/64" (2.0 mm)	3/32" (2.4 mm)	7/64" (2.8 mm)	1/8" (3.2 mm)	9/64" (3.5 mm)	5/32" (4.0 mm)	0.177" (4.5 mm)
DOUBLE-END TROCAR 							
6"	—	—	—	—	—	—	—
9"	GS71750	GS71753	GS71756	GS71759	GS71762	GS71765	GS71768
SINGLE TROCAR (ROUND END) 							
9"	GS71770	GS71773	GS71776	GS71779	GS71782	GS71785	GS71788
DOUBLE-END DIAMOND 							
9"	GS71730	GS71733	GS71736	GS71739	GS71742	GS71745	GS71748
SINGLE DIAMOND (ROUND END) 							
9"	GS71700	GS71703	GS71706	GS71709	GS71712	GS71715	GS71718
10"	—	GS71679	—	—	—	—	—

WIRE AND PIN IMPLANTS

STEINMANN PINS CALIBRATED (GUIDE WIRES) WITH 1/2" GRADUATIONS					
LENGTH	0.062"(1.6mm)	5/64"(2.0mm)	3/32"(2.4mm)	7/64"(2.8 mm)	1/8" (3.2 mm)
SINGLE TROCAR (ROUND END)					
9"	GS71173	—	—	—	—
SINGLE TROCAR 3 SHANK END					
9"	—	—	GS71833	—	—
SINGLE DIAMOND 3 SHANK END					
9"	—	—	GS71853	GS71856	GS71859
SINGLE DIAMOND 3 ROUND END					
9"	—	—	GS71873	—	—



GS71009

K-WIRE, STEINMANN PIN CASES

GS71009

13" x 5-1/4" x 2" (closed)

Holds 9" K-Wires; 9" Steinmann Pins.

K-WIRES - 1 ROW, HOLDS 4 EACH OF THE FOLLOWING:

0.028" (0.7 mm) 0.045" (1.1 mm)
0.035" (0.9 mm) 0.062" (1.6 mm)

STEINMANN PINS - 2 ROWS, HOLDS 4 EACH OF THE FOLLOWING:

5/64" (2.0 mm) 9/64" (3.5 mm)
3/32" (2.4 mm) 5/32" (4.0 mm)
7/64" (2.8 mm) 0.177" (4.5 mm)

1/8" (3.2 mm)

K-WIRE, STEINMANN PIN CASES

GS71010

11-3/4" x 5-1/4" x 2" (closed)

Holds 4", 6" and 9" K-Wires; 9" Steinmann Pins.

K-WIRES - 3 ROWS, HOLDS 4 EACH OF THE FOLLOWING:

0.028" (0.7 mm) 0.045" (1.1 mm)
0.035" (0.9 mm) 0.062" (1.6 mm)

STEINMANN PINS - 1 ROW, HOLDS 2 EACH OF THE FOLLOWING:

5/64" (2.0 mm) 9/64" (3.5 mm)
3/32" (2.4 mm) 5/32" (4.0 mm)
7/64" (2.8 mm) 0.177" (4.5 mm)

1/8" (3.2 mm)

KIRSCHNER WIRES, STEINMANN PIN, VICKERS K-WIRE DISPENSERS

K-WIRE DISPENSER 6-1/4"

CATALOG #	LENGTH	DIAMETER	QTY. HELD
GS71001	up to 6"	0.031" (0.8 mm)	100
GS71002	up to 6"	0.039" (1.0 mm)	50
GS71003	up to 6"	0.047" (1.2 mm)	40
GS71004	up to 6"	0.054" (1.4 mm)	25
GS71006	up to 6"	0.062" (1.6 mm)	20

- Stores and dispenses one size at a time.
- Sharp points are protected by silicone insert in cap.
- To avoid injury, load wire with blunt end down.
- Hexagonal shape of cap prevents unwanted movement of dispenser.
- Diameter is marked for easy identification.

K-WIRE DISPENSER 12-1/4"

GS71012	up to 12"	0.039" (1.0 mm)	50
GS71013	up to 12"	0.047" (1.2 mm)	40
GS71014	up to 12"	0.054" (1.4 mm)	25
GS71016	up to 12"	0.062" (1.6 mm)	20



GS71001 - GS71006
For K-Wire up to 6" long.

STEINMANN PIN DISPENSER 12-1/4"

GS71017	up to 12"	5/64" (2.0 mm)	10
GS71019	up to 12"	3/32" (2.5 mm)	5



GS71012 - GS71019
For K-Wire and pins up to 12" long. Plastic cap.

VICKERS K-WIRE DISPENSER

CATALOG #	LENGTH	CHAMBER #1		CHAMBER #2		CHAMBER #3		CHAMBER #4	
		DIAMETER	QTY. HELD	DIAMETER	QTY. HELD	DIAMETER	QTY. HELD	DIAMETER	QTY. HELD
GS46542	4"	0.039"(1.0mm)	60	0.047"(1.2mm)	40	0.055"(1.4mm)	30	0.063"(1.6mm)	18
GS46538	12"	0.039"(1.0mm)	60	0.047"(1.2mm)	40	0.055"(1.4mm)	30	0.063"(1.6mm)	18
GS46539	12"	0.070"(1.8mm)	15	5/64" (2.0 mm)	12	0.086"(2.2mm)	10	3/32" (2.5 mm)	8



GS46542
For 4" K-Wire.

- Easily stores and dispenses four different size wires.
- Dial on bottom enables for dispensing of one size at a time.
- To avoid injury, load wire with blunt end down.
- Dial can be locked to avoid accidental dispensing.
- Clearly marked chambers help to avoid mix-up.
- Dispenser is available exclusively from Teleflex®.



GS46538 - GS46539
For 12" K-Wire.

WIRE AND PIN IMPLANTS

Wire and Pin Drivers and Benders

ORTHOPEDIC INSTRUMENTS

WIRE BENDER



GS49802

Bends up to 1.6 mm (0.062") K-Wire to 90 degree angle.

CATALOG #	Description
GS49802	3 prong, 5-3/4" (14.5 cm)

K-WIRE AND PLATE BENDER



GS49724

Bends mini plates and up to 1.1 mm (0.045") K-Wire to 90 degree angle.

CATALOG #	Description
GS49724	3 prong, 5" (12.5 cm)

WIRE AND PIN IMPLANTS

Wire and Pin Drivers and Benders

ORTHOPEDIC INSTRUMENTS

STEINMAN PIN CHUCK



For insertion and removal of Steinmann Pins. Includes chuck key. Cannulation accepts wires and pins up to 0.236" (6.0 mm). Chuck accepts wires and pins up to 1/4" (6.35 mm).

CATALOG #	Description
GS48374	Fully cannulated, 4" (10 cm)

UNIVERSAL CHUCK WITH T-HANDLE



No more lost keys! Keyless chuck for insertion and removal of Steinmann Pins. Cannulation accepts wires and pins up to 0.236" (6.0 mm). Chuck accepts wires and pins up to 1/4" (6.35 mm).

CATALOG #	Description
GS47901	Fully cannulated with reverse lock, 4-1/2" (11.5 cm)
GS47903	Fully cannulated, 4" (10 cm)

WIRE AND PIN IMPLANTS

Wire and Pin Drivers and Benders

WIRE AND PIN BENDER



GS48372

Aids in bending pins and wires.

CATALOG #
GS48372

Description
Accepts wires and pins up to 1/8" (3.2 mm), overall
length 5-7/8" (15 cm)

WIRES AND WIRE/PIN/ROD CUTTERS

Wire Twisters

LOUTIE WIRE TIGHTENER

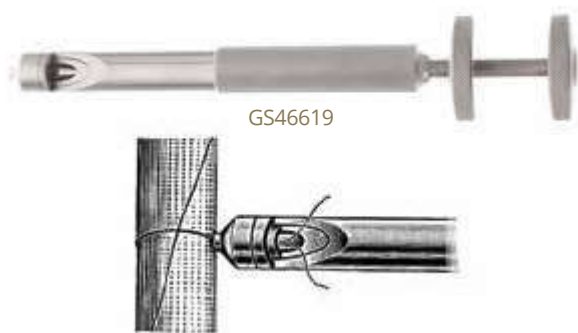

GS46619

CATALOG #
GS46619

Description
Maximum capacity 1.5 mm or 17 gauge cerclage wire, 8-1/2" (21.5 cm)

WIRE TWISTING FORCEPS



GS48322

GS48320

GS48324

Carbide inserts.

CATALOG #
GS48320
GS48322
GS48324

Description
6" (15 cm), TC
4 mm tip, 8" (21 cm), TC
6 mm tip, 7-1/4" (19 cm), TC

WIRES AND WIRE/PIN/ROD CUTTERS

Wire Twisters

ORTHOPEDIC INSTRUMENTS

WIRE PULLING FORCEPS



Facilitates holding and pulling of pins and wires.

CATALOG #	Description
GS46637	Maximum capacity 1 mm, 6-1/2" (17 cm)

CORWIN WIRE TWISTER

HOW TO USE THE CORWIN WIRE TWISTER:

1. Wrap wire around bone and position ends next to each other.
2. Grasp both ends of wire with jaws.
3. Engage the ratchet to enforce solid clamping.
4. Stabilize wiring site.
5. Pull back on center ring repeatedly until wire has reached desired tension.
6. Disengage ratchet.

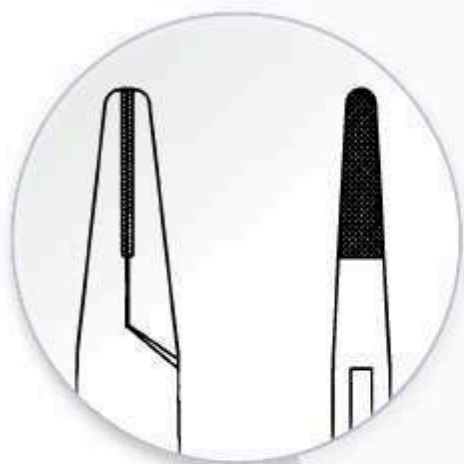

CORWIN WIRE TWISTER
GS46582
6-1/4" (16 cm) with carbide inserts
Maximum capacity 0.8 mm or 21 gauge
cerclage wire



Saves time by semi-automatically twisting soft wire.

P.I. WIRE TWISTER AND TIGHTENER

ORTHOPEDIC INSTRUMENTS



P.I. WIRE TWISTER AND TIGHTENER
GS69846
6-1/4" (16 cm)

FOLLOW THESE EASY STEPS TO TWIST AND TIGHTEN CERCLAGE WIRE:

1. Position wire around bone. Bend the ends of the wire slightly upwards.
2. Feed both twisted wire ends through the tongue and groove jaw and push out and up through the jaw fenestration.
3. Engage the ratchet. This will lock the wire in place. Turn the entire instrument, tightening the wire around the bone.

For more information please refer to the Instructions For Use.



JET WIRE TWISTER



JET WIRE TWISTER
GS49810
11" (28 cm)
10 mm tip

The Jet Wire Twister is designed to provide fast, smooth and even twisting of soft wire, saving time in the OR. Suitable for the entire range of cerclage wire.

HOW TO USE THE JET WIRE TWISTER:

1. Wrap wire around bone and position ends next to each other.
2. Grasp both ends of wire with jaw.
3. Engage the ratchet to enforce solid clamping.
4. Stabilize wiring site.
5. Pull back on t-handle repeatedly until wire has reached desired tension.
6. Disengage ratchet.

Note: Jaws can be customized. Please contact us for details.

For more information please refer to the Instructions For Use.

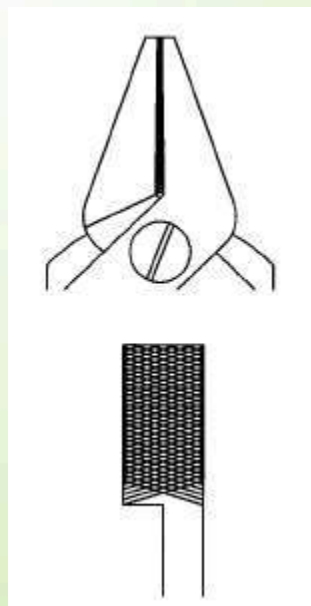

ABOUT WIRE AND PIN CUTTERS

Teleflex® can meet all of your wire and pin cutting requirements with our complete line of Stainless Steel Cutting Instruments.

MADE FROM STAINLESS STEEL

All of our wire cutters are engineered to meet the demanding needs of cutting rods, pins, cables and wires in the Operating Room. Jaws are made from the toughest specially tempered tool steel or have tungsten carbide inserts.

MORE CUTTING POWER

Cutters designed with double action give you more cutting power and help absorb the shock of wire cutting. There is better control and less fatigue for the surgeon.

MOST EXTENSIVE SELECTION

We offer more jaw and handle styles than any other instrument company.

NOTE ON CARBIDE INSTRUMENTS

Instruments with carbide inserts can be replaced; however, welded carbide jaws cannot be replaced.

TO ACHIEVE THE BEST RESULTS WHEN CUTTING WIRES AND PINS, FOLLOW THESE SIMPLE STEPS:

- Choose the appropriate cutter for the wire diameter you want to cut
- Do not exceed the maximum capacity marked on each cutter
- Cut wire in the middle of the jaw—not on the tip or in the corner
- Keep the jaw at right angles to the piece being cut. Do not twist or turn cutter

IMPORTANT NOTE ON MAXIMUM CAPACITIES

All maximum capacities noted in this catalog are based on tests using standard strength implant material. Cutting material which exceeds our recommended maximum capacities may damage or shorten the life of cutting edges and voids the instrument warranty. Please check the size of the material and the maximum capacity of the instrument before using.

For more information, please refer to the Instructions For Use.

WIRE TISSUE SANDWICH/PIN/ROD CUTTERS

Wire Cutters

DELICATE WIRE CUTTER



Delicate side-cutting jaws with carbide inserts. Especially useful for pediatric, foot and hand surgery.

CATALOG #	Description
GS46622	Side cutting with carbide inserts, maximum capacity 0.028" (0.7 mm), 4-7/8" (12.5 cm)

GS46622

STAINLESS STEEL WIRE CUTTING FORCEPS



CATALOG #	Description
142550	6-7/8" (17.5 cm)

142550

WIRE CUTTERS



142519

CATALOG #	Description
142519	Single action, 7-7/8" (20 cm), TC
142520	Angled jaw, double action, 8-1/2" (21.5 cm), TC



142520

WIRES AND WIRE/PIN/ROD CUTTERS

Wire Cutters

SIDE CUTTER



GS46621

CATALOG #
GS46621

Description
Side cutting, welded carbide jaws, maximum capacity 0.062" (1.6 mm), 7-1/4" (18.5 cm)

SIDE CUTTER



GS49736

Welded carbide jaws.

CATALOG #
GS49736

Description
Maximum capacity 3/32" (2.4 mm), 9" (23 cm)

K-WIRE SIDE CUTTER



GS49734

SR 49734 SR 49734 CU, Old

Welded hardened jaws.

CATALOG #
GS49734

Description
Maximum capacity 0.045" (1.1 mm), 6" (15 cm)

WIRE CUTTERS

Wire Cutters

WIRE CUTTER WITH SAFETY INSERTS



Combines maximum leverage and optimum safety. The Wire Cutter with Safety Inserts can help prevent the potentially dangerous occurrence of flying K-Wire pieces in the OR. This instrument is designed to hold the cut piece of wire in its silicon inserts. After cutting, the remnant wire can be safely disposed of, thus preventing cut pieces from falling into the wound site or flying into the air. The silicon inserts are autoclavable and long-lasting. And since inserts are not glued into the jaws, replacement is fast and easy. Simply insert the new ones by pressing them into place. Inserts do not fall out or move under normal circumstances. Front and side cutting, double action.

CATALOG #	Description
GS49740	Maximum capacity 0.062" (1.6 mm), 6-7/8" (17.5 cm)
GS49740P	Set of replacement silicon inserts

DOUBLE ACTION WIRE CUTTERS



GS46623

Narrow jaw makes this cutter a favorite with hand and foot surgeons.

CATALOG #	Description
GS46623	Angled, side cutting with carbide inserts, maximum capacity 0.062" (1.6 mm), 6-5/8" (17 cm)
GS46624	Angled, side cutting with carbide inserts, maximum capacity 3/32" (2.4 mm), 8-1/2" (21.5 cm)

WIRE TIE WISTERS AND WIRE/PIN/ROD CUTTERS

Wire Cutters

ORTHOPEDIC INSTRUMENTS

FRONT AND SIDE WIRE CUTTER



GS46625

CATALOG #
GS46625

Description
Front and side cutting with carbide inserts, double action, maximum capacity 0.062" (1.6 mm), 6-3/4" (17 cm)

FLUSH WIRE CUTTER



GS46631

This improved version of our Front and Side Cutter cuts flush to the bone like no other wire cutter. This is a big advantage in buried wire procedures.

CATALOG #
GS46631

Description
Front and side cutting with carbide inserts, double action, maximum capacity 0.059" (1.5 mm), 6-3/4" (17 cm)

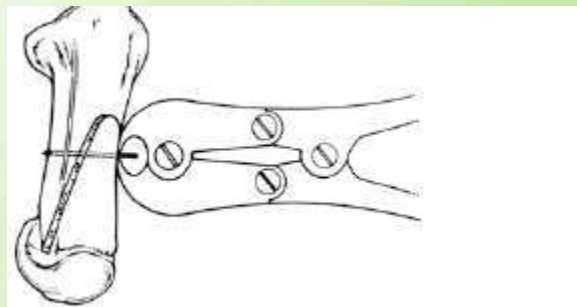

WIRES AND WIRE/PIN/ROD CUTTERS

Wire Cutters

K-WIRE END CUTTER



CATALOG #	Description
GS49735	Maximum capacity 0.045" (1.1 mm), 5-1/2" (14 cm)

END CUTTER



Welded carbide jaws.

CATALOG #	Description
GS49738	Maximum capacity 3/32" (2.4 mm), 8-1/2" (21.5 cm)

Pin Cutters

CANNULATED PIN CUTTER



Cannulation allows you to slide the cutter over the inserted wire. The piece cut off will be held safely inside the channel.

CATALOG #	Description
GS46647	End cutting, maximum capacity 0.062 (1.6 mm), 7-1/4" (18.5 cm)

WIRES AND WIRE/PIN/ROD CUTTERS

Pin Cutters

ORTHOPEDIC INSTRUMENTS

DIAMOND PIN CUTTER



GS46651

Disassembles easily for cleaning.

CATALOG #	Description
GS46651	End cutting, maximum capacity 5/64" (2 mm), 6-3/8" (16 cm)

END CUTTER



GS46649

CATALOG #	Description
GS46649	End cutting, welded carbide jaws, maximum capacity 0.062" (1.6 mm), 5-3/4" (14.5 cm)

DOUBLE ACTION PIN CUTTER



GS49800

Double action handles give more power to cut pins up to 1/8" (3.2 mm). Side cutting.

CATALOG #	Description
GS49800	Maximum capacity 1/8" (3.2 mm), 9-1/2" (24 cm)

WIRE T WISTERS AND WIRE/PIN/ROD CUTTERS

Pin Cutters

SIDE PIN CUTTER



GS46629

Heavy duty cutter for rods up to 4 mm and heavy Steinmann pins. Slightly angled jaws house long-lasting special carbide inserts for cutting hard titanium and stainless steel rods.

CATALOG #	Description
GS46629	Side cutting with carbide inserts, maximum capacity 5/32" (4 mm), 15" (38 cm)

SMALL PIN CUTTER



GS46632

CATALOG #	Description
GS46632	Maximum capacity 1/8" (3.2 mm), 10-1/4" (26 cm)

MEDIUM PIN CUTTER



GS46633

Heavy duty cutters with replaceable jaws.

CATALOG #	Description
GS46633	Maximum capacity 3/16" (4.7 mm), 14-3/8" (36.5 cm)

LARGE PIN CUTTER

Only available from Teleflex®

ORTHOPEDIC INSTRUMENTS

FREE-FLOATING BOLTS
PREVENT STRESS BUILDUP
AND TIGHTENING

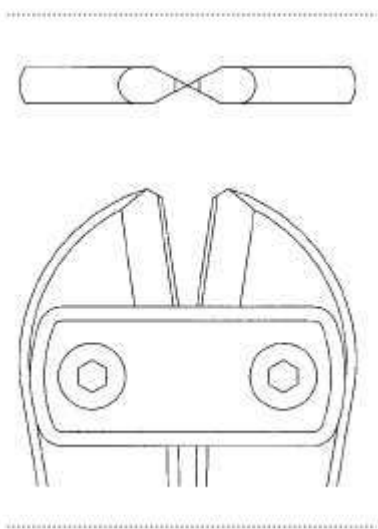

PIN CUTTER (LARGE)
GS46626
22-5/8" (57.5 cm)
Maximum capacity 1/4" (6.3 mm)

Precisely ground jaws are made from the hardest stainless steel available. This redesigned cutter will cut harder spinal rods for a longer period of time.

IMPORTANT: This large cutter is not designed to be used inside the patient's body.



PRECISION-GROUND
CUTTING EDGES
PRODUCE SUPERIOR
CUTTING ABILITY

JAWS ARE MADE OF THE
HARDEST STAINLESS TOOL
STEEL FOR LONG LIFE

STOP ON HANDLE
PREVENTS OVERLOAD
ON JAWS

HOLLOW HANDLES ARE
STRONG BUT LIGHT

COMFORTABLE, NON-
KNURLED HANDLE

WIRET WISTERSANDWIRE/PIN/RODCUT TERS

Pin Cutters

PLATE CUTTING FORCEPS



GS47932

For cutting stainless steel mini plates up to 1 mm.

CATALOG #	Description
GS47932	Straight, 9-1/4" (24 cm)

CABLE CUTTER

Cuts cleanly through cables without fraying

ORTHOPEDIC INSTRUMENTS

DURABLE TUNGSTEN
CARBIDE JAWS CUT
HARD CABLES
SMOOTHLY AND EASILY

STRONG JOINT DESIGN IS
LONG-LASTING AND
ALLOWS PRECISE CUTTING

HANDLE STOP FOR
DEFINED JAW TRAVEL

JAW ANGLE CAPTURES
THE CABLE, THEN CUTS
THROUGH ALL STRANDS
AT ONCE—ELIMINATING
FRAYED ENDS

CUTS THROUGH CABLE
WITH ONE CUT—REDUCING
RISK OF SMALL CABLE
PARTICLES FALLING INTO
OPERATING SITE

CABLE CUTTER
GS48378
7" (18 cm)
Maximum capacity 2.0 mm
Cable jaws can be resharpened and
replaced.

NOTE: This instrument should only be
used for cutting cable. Lubricate joint to
ensure proper function.

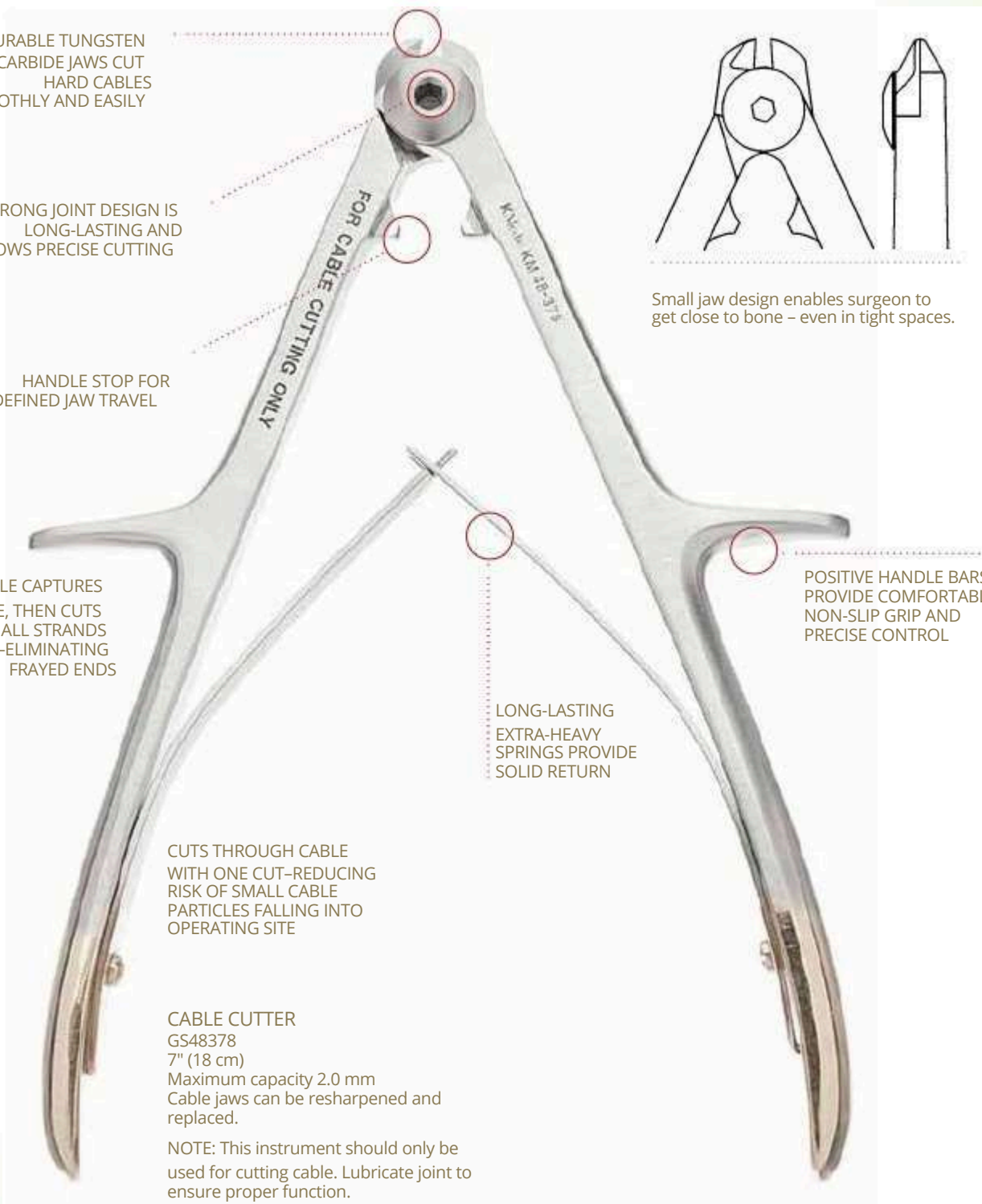

Small jaw design enables surgeon to
get close to bone – even in tight spaces.

POSITIVE HANDLE BARS
PROVIDE COMFORTABLE
NON-SLIP GRIP AND
PRECISE CONTROL

LONG-LASTING
EXTRA-HEAVY
SPRINGS PROVIDE
SOLID RETURN

WIRED WISTERSANDWIRE/PIN/RODCUTTERS

Rod Cutters

HAND-HELD ROD CUTTER

All of the benefits of the table top cutter in a hand-held model. Cuts rods from 4.76 mm (3/16") to 6.35 mm (1/4"). **IMPORTANT:** This large cutter is not designed to be used inside the patient's body.

CATALOG #	Description
GS46635	Stainless steel with silicone handle, 27" (68.5 cm)



TABLE TOP ROD CUTTER

Provides an easy and safe way to cut spinal rods

ORTHOPEDIC INSTRUMENTS



TABLE TOP ROD CUTTER

GS46628

27-1/2" (70 cm)

Cuts rods from 4.76 mm (3/16") to 6.35 mm (1/4")

Powerful double-action jaws enable surgeons to cut 1/4" rods with one hand. Shearing action cuts cleanly - no raised burrs or sharp, jagged edges. Unique cutting process can help prevent the potentially dangerous occurrence of flying rod pieces in the OR.

Ergonomically designed Ortho-Grip™ Silicone Handle provides a comfortable, slip-proof grip. Base and handle are perfectly balanced to ensure stability and prevent lifting. Simple, efficient design has no folding levers, loose parts or bearings that can break down. Cuts rods from 4.76 mm (3/16") to 6.35 mm (1/4").

HOW TO USE THE TABLE TOP ROD CUTTER:

1. Lift handle up.
2. Insert rod in proper diameter hole.
3. Press handle down.

Ortho-Grip is a trademark or registered trademark of Teleflex Corporation or its affiliates.

WIRE GUIDES & DRILL BITS

WIRE GUIDES AND TRACTION BOWS

ORTHOPEDIC INSTRUMENTS

EMEL WIRE GUIDES



CATALOG #	Description
GS48380	30 mm diameter, 10-1/2" (26.5 cm)
GS48382	47 mm diameter, 11-1/2" (29 cm)
GS48384	57 mm diameter, 12-1/2" (32 cm)

WIRE AND PIN TRACTOR (BOEHLER)



Each Wire and Pin Tractor comes with a pack of 6 trocar round-end Steinmann Pins as listed.

CATALOG #	Size	INSIDE LENGTH	INSIDE WIDTH	PIN INCLUDED	PIN SIZE AND DIAMETER
GS48326	Small	90 mm	75 mm	GS71432	5" 2.4 mm
GS48328	Medium	160 mm	90 mm	GS71434	7" 3.2 mm
GS48330	Large	210 mm	150 mm	GS71525	9" 4.0 mm

KIRSCHNER BOWS



Each Kirschner Bow comes with three hooks.

CATALOG #	Description
GS48270	Small, 5-3/4" (14.5 cm)
GS48272	Large, 7-1/2" (19 cm)
GS48274	Extra large, 9-5/8" (24.5 cm)

LIGATURE CARRIERS AND WIRE PASSERS

WIRE PASSERS (CANNULATED)



GS48386

Cannulation allows for easy feeding of wire around the bone.

CATALOG #	Description
GS48386	45 mm diameter, 7" (18 cm)
GS48388	70 mm diameter, 9-1/2" (24 cm)

SUTURE PASSERS



GS46917

GS46918

Used to pass sutures in shoulder surgery. Curved, 9-1/4" (23.5 cm).

CATALOG #	Description
GS46917	With crochet hook
GS46918	With suture hole

Autoclavable to 290°F (143°C)

DRILLS, DRILL BITS AND GUIDES

Drills — Hand Drills

BUNNELL DRILL



GS48392

Accepts wires and pins up to 4.0 mm (5/32"). Store chuck key in handle. Body is made of aluminum.

CATALOG #	Description
GS48392	Cannulated, 3-jaw stainless Jacobs chuck, includes key chuck, 5-3/4" (14.5 cm)
GS48392P	Key only, stored in drill handle

MARTIN DRILL



GS48415

Stainless drill, anodized aluminum handle.

CATALOG #	Description
GS48415	10-1/2" (26.5 cm)

MOORE DRILL AND BIT SET



GS48420

Drill is chrome plated with stainless handle.

CATALOG #	Description
GS48423	Moore Drill and complete set of stainless drill bits
GS48420	Drill only, 11" (28 cm)
GS48421	Drill bit, 70 mm length, 3.2 mm diameter
GS48422	Drill bit, 90 mm length, 3.2 mm diameter

DRILLS, DRILL BITS AND GUIDES

Drills — Hand Drills

RALKS DRILL



Includes key chuck. Accepts wires and pins up to 6.35 mm (1/4"). Offset handle. Body is made of aluminum.

CATALOG #	Description
GS48390	Cannulated, 3-jaw stainless chuck, 5-3/4" (14.5 cm)
GS48390P	Key only

STILLE-SHERMAN DRILL



CATALOG #	Description
GS48469	Drill and complete set of stainless drill bits and burrs
GS48465	Drill only, with quick coupling, chrome plated, stainless handle, 9-1/2" (24 cm)
GS48466	Drill bit, 2.5 mm
GS48467	Drill bit, 3.0 mm
GS48468	Drill bit, 3.5 mm

DRILLS, DRILL BITS AND GUIDES

Drills — Hand Drills

ORTHOPEDIC INSTRUMENTS

UNIVERSAL DRILL



This hand drill has a two-to-one gear ratio to ensure accurate drilling. The comfortable pistol grip offset handle gives the user perfect control. The chuck shaft and the entire length of the drill are cannulated. The cannulated shaft accepts Steinmann Pins, K-Wire, long shank drills and screwdriver bits up to 4 mm (5/32").

CATALOG #	Description
GS48394	Cannulated, stainless chuck, includes key chuck. Chuck accepts wires and pins up to 6.35 mm (1/4"). Body is made of aluminum, 10" (25.5 cm)

HUDSON DRILL BITS



For use with GS48454 Hudson Drill.

CATALOG #	Description
GS48460	Cushing Drill bit, 14 mm
GS48461	Drill bit, 2 mm
GS48462	McKenzie Drill bit, 13 mm
GS48463	D'Errico Drill bit, 16 mm

DRILLS, DRILL BITS AND GUIDES

Drills — Hand Drills

HUDSON DRILL AND BURRS



GS48454

Burrs sold separately.

CATALOG #	Description
GS48454	Drill only, all stainless steel with improved snap-lock chuck, 10-1/2" (26.5 cm)
GS48456	Hudson Burr, 9 mm
GS48457	Hudson Burr, 14 mm
GS48458	Hudson Burr, 16 mm
GS48459	Hudson Burr, 22 mm
GS48455	Extension Piece, 3-7/8" (9.5 cm)



GS48456



GS48457



GS48458



GS48459



GS48455

DRILLS, DRILL BITS AND GUIDES

Drills — Quick Coupling Handles

MINI QUICK COUPLING HANDLE



GS47902

For holding quick coupling drills, countersinks, taps and screwdrivers.

CATALOG #	Description
GS47902	For mini screw set, 4-1/8" (10.5 cm)
GS47908	Rounded phenolic handle, 4-3/8" (11 cm)

QUICK COUPLING T-HANDLE



GS47960

For holding quick coupling drills, countersinks, taps and screwdrivers.

CATALOG #	Description
GS47960	For small and large screw sets, 3-1/2" (8.5 cm)

QUICK COUPLING HANDLE



GS47904

For holding quick coupling drills, countersinks, taps and screwdrivers.

CATALOG#	Description
GS47904	4-1/2" (11.5 cm) Autoclavable to 290°F (143°C)

Drills — Adapters

ADAPTER (POWER DRILL)



GS45002

With quick coupling end.

CATALOG #	Description
GS45002	2-1/2" (6.5 cm)

DRILL BIT CASE

The Drill Bit Case provides easy access and can hold up to 19 5" (127 mm) Jacobs chuck* drill bits.

- Reduce footprint: Lid folds back and holds the case upright
- Prevent drill bit damage: Tray lowers and holds drill bits in place when closing lid
- Prevent accidental opening: Top of case locks when closed
- Quick identification: Drill bit sizes and part numbers are clearly noted on the inside of case

EASY TO CLEAN

- Innovative one-piece design eliminates the risk of losing drill bits
- Anodized aluminum case is lightweight, yet built to withstand abuse

DRILL BIT CASE

GS48100

Drill Bit Case - 5" (127 mm)

Holds 2 each of the 5" Jacob's chuck drill bits (1 each of size 6.0 mm):

5.5" x 4.25" x 1.75" (140 mm x 108 mm x 45 mm)

GS48100

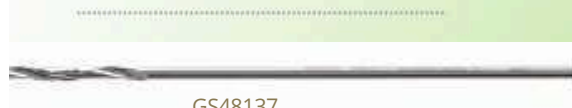

GS48137

5" JACOB'S CHUCK DRILL BITS

CATALOG #	Description	FLUTE LENGTH
GS48129	1.0 mm x 127 mm	22.0 mm
GS48130	1.5 mm x 127 mm	22.0 mm
GS48132	2.0 mm x 127 mm	23.0 mm
GS48134	2.4 mm x 127 mm	22.0 mm
GS48136	2.7 mm x 127 mm	30.0 mm
GS48137	3.2 mm x 127 mm	42.0 mm
GS48138	3.5 mm x 127 mm	42.0 mm
GS48140	4.0 mm x 127 mm	35.0 mm
GS48142	4.7 mm x 127 mm	34.0 mm
GS48143	6.0 mm x 127 mm	37.0 mm

DRILL BIT CASE SET (FULLY LOADED)

GS48144

QUANTITY	INCLUDES	QUANTITY	INCLUDES
2	1.0 mm Drill Bit	2	3.2 mm Drill Bit
2	1.5 mm Drill Bit	2	3.5 mm Drill Bit
2	2.0 mm Drill Bit	2	4.0 mm Drill Bit
2	2.4 mm Drill Bit	2	4.7 mm Drill Bit
2	2.7 mm Drill Bit	1	6.0 mm Drill Bit



GS48144

DRILLS, DRILL BITS AND GUIDES

Drill Bits — Jacobs Chuck End

DRILL BITS



With round drill chuck end. Designed to fit any Jacobs chuck drill.

CATALOG #	DIAMETER	FLUTE LENGTH	OVERALL LENGTH
GS48070	1.0 mm	25mm	2-1/8" (5.5 cm)
GS48072	1.1 mm	11mm	1-3/4" (4.5 cm)
GS48071	1.5 mm	30mm	2-3/4" (7 cm)
GS48073	2.0 mm	38mm	3-3/8" (8.5 cm)
GS48076	2.5 mm	43mm	3-3/4" (9.5 cm)
GS48077	2.7 mm	32mm	3-3/8" (8.5 cm)
GS48080	3.2 mm	40mm	5-1/8" (13 cm)
GS48079	3.2 mm	70mm	7-1/8" (18 cm)
GS48081	3.5 mm	42mm	3-3/4" (9.5 cm)
GS48082	3.5 mm	50mm	7-1/8" (18 cm)
GS48085	4.5 mm	55mm	5-1/8" (13 cm)
GS48086	6.0 mm	70 mm Extra-Long	7-1/8" (18 cm)

Drill Bits — Quick Coupling End

DRILL BITS



With quick coupling ends. To drill gliding and threaded holes. Designed to fit quick coupling handles GS47902, GS47904 and GS47960.

CATALOG #	DIAMETER	FLUTE LENGTH	WORKING LENGTH	OVERALL LENGTH
GS48051	1.1 mm	20 mm	35 mm	2-3/8" (6 cm)
GS48052	1.5 mm	23 mm	60 mm	3-3/8" (8.5 cm)
GS48054	2.0 mm	50 mm	75 mm	3-7/8" (10 cm)
GS48057	2.5 mm	50 mm	85 mm	4-3/8" (11 cm)
GS48058	2.7 mm	50 mm	75 mm	3-7/8" (10 cm)
GS48061	3.2 mm	50 mm	120 mm	5-3/4" (14.5 cm)
GS48060	3.2 mm	50 mm	170 mm Extra-Long	7-5/8" (19.5 cm)
GS48063	3.5 mm	50 mm	85 mm	4-3/8" (11 cm)
GS48050	3.5 mm	50 mm	170 mm Extra-Long	7-5/8" (19.5 cm)
GS48067	4.5 mm	50 mm	120 mm	5-3/4" (14.5 cm)
GS48068	4.5 mm	50 mm	170 mm Extra-Long	7-5/8" (19.5 cm)
GS48069	6.0 mm	60 mm	170 mm Extra-Long	7-5/8" (19.5 cm)

DRILLS, DRILL BITS AND GUIDES

Drill Bits — Three-Fluted Drill Bits

THREE-FLUTED DRILL BITS

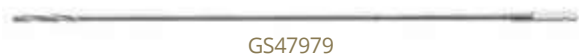

GS47979

With quick coupling ends.



GS47981

CATALOG #	DIAMETER	FLUTE LENGTH	WORKING LENGTH	Overall LENGTH
GS48091	2.5 mm	30 mm not calibrated	85 mm	4-3/8" (11 cm)
GS48092	2.5 mm	28 mm not calibrated	155 mm	7-1/8" (18 cm)
GS47986	2.5 mm	30 mm calibrated	205 mm	9" (23 cm)
GS48093	3.2 mm	38 mm not calibrated	120 mm	5-3/4" (14.5 cm)
GS48094	3.2 mm	38 mm not calibrated	170 mm	7-5/8" (19.5 cm)
GS47979	3.2 mm	30 mm calibrated	205 mm	9" (23 cm)
GS48095	4.5 mm	45 mm not calibrated	120 mm	5-3/4" (14.5 cm)
GS47981	4.5 mm	58 mm not calibrated	170 mm	7-5/8" (19.5 cm)

DRILLS, DRILL BITS AND GUIDES

Drill Bits — Countersinks

MINI COUNTERSINK



For mini screws 1.5/2.0 mm. Mini quick coupling end.

CATALOG #	Description
GS47920	1.1 mm tip, 2-1/4" (5.5 cm)

SMALL COUNTERSINKS



For small screws 2.7/3.5/4.0 mm. Quick coupling end.

CATALOG #	Description
GS47922	2.0 mm tip, 2-7/8" (7 cm)
GS47923	90 degrees, 2.0 mm tip, 2-1/2" (6 cm)

MALLEOLAR COUNTERSINK



For malleolar screws. Quick coupling end.

CATALOG #	Description
GS47924	3.2 mm tip, 4-1/2" (11.5 cm)

DRILLS, DRILL BITS AND GUIDES

Drill Bits — Countersinks

LARGE COUNTERSINK



For large screws 4.5/6.5 mm.

CATALOG #	Description
GS47926	4.5 mm tip, 7-1/8" (18 cm)

Drill Bits — Taps

TAPS



With quick coupling ends, calibrated with cm graduations.

CATALOG #	Description
GS48104	3.5 mm diameter, for cortical screws, 7"
GS48102	Mini quick coupling, 4.5 mm diameter, for cortical screws, 7"
GS48122	6.5 mm diameter, for cancellous screws, 8"

TAPS

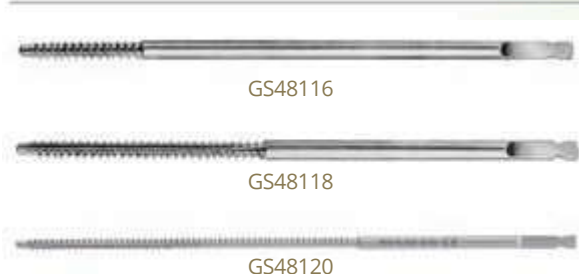

With quick coupling ends, for 4.5 mm cortical and 4.5 mm malleolar (shaft) screws.

CATALOG #	Description
GS48116	5"
GS48118	Long thread, 5"
GS48120	Extra-long thread, 5"

DRILLS, DRILL BITS AND GUIDES

Drill Bits — Taps

TAPS

Taps: Used to prepare thread path for insertion of bone screws. With quick coupling ends.

CATALOG #	Description
GS48106	Mini quick coupling, 1.5 mm diameter, for cortical screws, thread pitch 0.5 mm, 2"
GS48108	Mini quick coupling, 2.0 mm diameter, for cortical screws, thread pitch 0.6 mm, 2-1/8"
GS48110	2.7 mm diameter, for cortical screws, thread pitch 1.0 mm, 4"
GS48112	3.5 mm diameter, fine thread, for cortical screws, thread pitch 1.25 mm, 4-3/8"
GS48114	3.5 mm diameter, coarse thread, for 3.5 and 4.0 mm cancellous screws, thread pitch 1.75 mm, 4-3/8"



GS48106



GS48108



GS48110



GS48112



GS48114

DRILLS, DRILL BITS AND GUIDES

Drill Guides and Sleeves

DRILL GUIDES



Drill guide ends are color coded.

Green = neutral

Gold = load

CATALOG #

Description

GS47977

2.0 mm, neutral and load end, for 2.0 mm drill bit and 2.7 mm cortical screw, 5-3/8" (13.5 cm)

GS48003

2.0 mm, neutral and load end, for 1.5 mm drill bit and 2.0 mm cortical screw, 4-3/8" (11 cm)

GS47978

2.5 mm, neutral and load end, for 2.5 mm drill bit and 3.5 mm cortical screw, 6-1/8" (15.5 cm)

GS47980

3.2 mm, neutral and load end, for 3.2 mm malleolar (shaft) drill bit and 4.5 mm cortical screw, 6-1/2" (16.5 cm)

UNIVERSAL DRILL GUIDE



Can be used as neutral/load drill guide.

CATALOG #

Description

GS48004

For 3.5 mm cortical screws and 3.5 mm malleolar (shaft) screws and 2.5 mm drill bits, 5-1/2" (14 cm)

GS47985

For 4.5 mm cortical screws and 4.5 mm malleolar (shaft) screws and 3.2 mm drill bits, 7-1/8" (18 cm)

DRILLS, DRILL BITS AND GUIDES

Drill Guides and Sleeves

ORTHOPEDIC INSTRUMENTS

PARALLEL DRILL GUIDE AND DRILL SLEEVE



GS47970

CATALOG #
GS47970

Description
2 mm tip, three holes and one hole for 2.0 mm drill bits, 4-1/2" (11.5 cm)

DOUBLE DRILL SLEEVES



GS47972

CATALOG #

GS47968

GS47966

GS48002

GS47972

GS47967

GS47965

Description
For 1.1 mm and 1.5 mm drill bits and tap for 1.5 mm cortical screws
For 1.5 mm and 2.0 mm drill bits and tap for 2.0 mm cortical screws
For 2.0 mm and 2.7 mm drill bits and tap for 2.7 mm cortical screws
For 2.5 mm and 3.5 mm drill bits, tap for 3.5 mm cortical screws and tap for 4.0 mm cancellous screws
For 3.2 mm and 4.5 mm drill bits, tap for 4.5 mm cortical screws and tap for 4.5 mm malleolar (shaft) screws
For 3.2 mm drill bits and tap for 6.5 mm cancellous screws

DRILL SLEEVES



GS47976

CATALOG #
GS47976

GS47982

Description
40 mm long tip, for 3.2 mm drill bits, for round hole and semi-tubular plates, 4-1/2" (11.5 cm)
60 mm long tip, for 3.2 mm drill bits, for round hole plates, 5" (12.5 cm)

DRILLS, DRILL BITS AND GUIDES

Drill Guides and Sleeves

INSERT DRILL SLEEVE



CATALOG #
GS47974

Description
For 2.5 mm drill bits and long 3.5 mm lag screws,
1-5/8" (4 cm)

INSERT DRILL SLEEVE



CATALOG #
GS47973

Description
For 3.2 mm drill bits and 4.5 mm lag screws, 3-1/8"
(8 cm)

TAP SLEEVES



Also can be used as 3.2 mm drill bit guide.

CATALOG #
GS47971

Description
For 3.2 mm drill bits, 4-1/2" (11.5 cm)

DRILLS, DRILL BITS AND GUIDES

Drill Guides and Sleeves

ORTHOPEDIC INSTRUMENTS

TAP SLEEVES



GS47969

Also can be used as 4.5 mm drill bit guide.

CATALOG #	Description
GS47969	4.5 mm diagonal, with toothed tip and tissue protector sleeve for 4.5 mm tap, 5-1/2" (14 cm)

GUIDEWIRE W/DRILLPOINT

CATALOG #	Description
GS48282	2mmx98cm
GS48284	3mmx98cm

POINTED DRILL GUIDE



GS47975

Used with tap sleeve GS47969 or GS47967.

CATALOG #	Description
GS47975	For 4.5 mm cortical screws, 6" (15 cm)

TREPHINES

MICHELE TREPHINE



GS48240

Designed for bone biopsy. Also facilitates removal of broken bone screws. 7-1/2" (19 cm).

CATALOG #	Description
GS48239	Small, 3 mm I.D., 5 mm O.D.
GS48240	Medium, 4 mm I.D., 6 mm O.D.
GS48241	Large, 6 mm I.D., 8.1 mm O.D.

P.I. PLUG CUTTER



GS48252

When removing K-Wire, use the Plug Cutter to extract a tiny cylinder of bone around the tip of the wire.

CATALOG #	Description
GS48252	3 mm I.D., 5 mm O.D., length with obturator 4-1/2" (11.5 cm)

PLUG CUTTER



GS69832

- These cutters are especially useful for arthrodesis of small and large joints by plug cutter graft technique.
- The plug cutters are designed to be used in pairs.
- The smaller diameter instrument will cut the plug opening and the larger one will harvest a bone graft that will fit into the opening. The plug can then be
- tapped into place using the Bone Impactor (GS69980). 6" (15 cm).
-

CATALOG #	Description
GS69830	5 mm I.D., 7 mm O.D.
GS69832	7 mm I.D., 9 mm O.D.
GS69834	10 mm I.D., 12 mm O.D.
GS69836	12 mm I.D., 14 mm O.D.
GS69838	20 mm I.D., 22 mm O.D.
GS69840	22 mm I.D., 24 mm O.D.

MEASURING DEVICES

MEASURING DEVICES

Rulers

FLEXIBLE RULERS



GS39694

Inch and millimeter graduated.

Catalog #	Description
GS39692	6" (152 mm)
GS39694	8" (203 mm)
GS39698	12" (305 mm)
GS39700	20" (508 mm)

KUNTSCHER X-RAY SCALE



GS48299

Ruler for X-rays.

Catalog #	Description
GS48299	Graduated in mm, 19-5/8" (50 cm)

MEASURING DEVICES

Calipers

ORTHOPEDIC INSTRUMENTS

ASTOVIEJO CALIPER



GS53042

Catalog #
GS53042

Description
Graduated in mm up to 40 mm, 6-1/2" (16.5 cm)

TOWNLEY FEMUR CALIPER



GS48314

Takes inside and outside measurements up to 4" (10 cm).

Catalog #
GS48314

Description
4-1/2" (11.5 cm)

NEURO CALIPER



GS48315

Inside measuring faces extra long (60 mm) for neurosurgery. Inside and outside measuring faces and depth bar, stainless steel.

Catalog #
GS48315

Description
Graduated in inch/mm to 5-3/4" (145 mm), 9" (23 cm)

MEASURING DEVICES

Specialty

BONE COMPASS



GS48302

Catalog #
GS48302

Description
8" (20.5 cm)

POLK FINGER GONIOMETER



GS48310

Catalog #
GS48310

Description
Graduated in inch and cm, 6" (15 cm)

SMARTRACKS

CLEANPUNCH® CLEANING SYSTEM

- Hold six CleanPunches® in open position for maximum exposure during cleaning.
- Lightweight anodized aluminum construction.
- Minimize footprint—compact design has removable lid that fits under rack.
- When open, instrument handles are exposed for quick identification and easy access in the OR.
- Silicone-coated brackets prevent metal to metal contact.
- Protects sharp cutting edges during cleaning.
- Fits inside a standard container or can be wrapped separately.

Catalog #	Description
GS59200	Approximately 13-1/2" x 7" x 6"

GS59200

SMARTRACKS FOR OSTEOTOMES

HOKE SMARTRACK

GS98150

8-1/4" x 5" x 2-1/4"

(21 cm x 12.5 cm x 5.5 cm)

Holds eight 5-1/4" (13.5 cm)

LIGHTWEIGHT RACKS FOR STERILIZATION AND STORAGE

- Nylon coated brackets help avoid metal-to-metal contact.
- Plastic plate on underside of top bracket helps protect sharp tips from being damaged.
- Side arm stays locked to help prevent instruments from falling out, even when turned upside down.
- Deep brackets hold instruments in place.
- Custom designed base keeps instruments upright during loading and unloading
- Reinforced, sturdier frames are made from corrosion-resistant anodized aluminum.
- Fully autoclavable to 270°F/132°C.
- Quick reference chart easily identifies the type and size instrument rack holds.
- Manufactured only by Teleflex®.

SMARTRACKS

ORTHOPEDIC INSTRUMENTS

BRUN SMARTRACK FOR 7" CURETTES

Aluminum and stainless steel, nylon coated brackets.

Catalog #	Description
GS98160	Holds 12 7" Brun Currettes

GS98160

COBB SMARTRACK FOR 11" INSTRUMENTS

Aluminum and stainless steel, nylon coated brackets.

Catalog #	Description
GS98170	Holds nine 11" Cobb Currettes, Elevators or Gouges

GS98170

SMARTRACKS

HIBBS AND BRUN SMARTRACK FOR 9" INSTRUMENTS

Aluminum and stainless steel, nylon coated brackets.

Catalog #	Description
GS98180	Holds 12 9" Brun Currettes, or Hibbs Chisels, Gouges or Osteotomes

GS98180

SMARTRACK LAMBOTTE FOR 9" OSTEOTOMES

Catalog #	Description
GS98190	Holds 12 9" (23 cm) Lambotte Osteotomes, 11-3/4" x 5-1/2" x 3-3/8" (30 x 8.5 x 14 cm), nylon coated brackets

GS98190

SMARTRACKS

SMITH PETERSON SMARTRACK

Holds 14 8" Smith Peterson osteotomes or gouges, nylon coated brackets.

Catalog #	Description
GS98195	Approximately 11" x 10" x 4" (28 x 25.5 x 10 cm)

GS98195

MISCELLANEOUS ORTHOPEDIC

Lead Hands

LEAD HANDS



GS49090

Oxidation of lead surfaces is a normal process. To prolong the life of lead hands, autoclave temperatures should not exceed 248° F (120° C). Avoid using chemical sterilization as it can cause severe corrosion.

Catalog #	Description
GS49090	Adult, 14-1/2" (37 cm)
GS49092	Child, 9-1/2" (24 cm)

LEAD HANDS



GS49093

Thinner and more flexible model. Longer fingers wrap on ends, eliminating side tabs.

Catalog #	Description
GS49093	Adult, 2 mm thick, 9-1/2" (24 cm)

MISCELLANEOUS GENERAL

Measuring Devices

POLK FINGER GONIOMETER



GS48310

Graduated in centimeters and inches.

Catalog #	Description
GS48310	6" (15 cm)

CASTROVIEJO CALIPERS



GS53042

Catalog #	Description
GS53042	Graduated to 40 mm, 6-1/2" (16.5 cm)
428630	Straight, 0-20 mm scale, 3-3/8" (8.5 cm)



428630

BONE COMPASS



GS48302

Catalog #	Description
GS48302	8" (20.5 cm)

MISCELLANEOUS GENERAL

Measuring Devices

TOWNLEY FEMUR CALIPER



GS48314

Catalog #
GS48314

Description
Takes inside and outside measurements
up to 4" (10 cm)

FOX CURETTES



GS29498

Round, 5-1/2" (14 cm).

Catalog #
GS29495
GS29496
GS29497
GS29498
GS29499
GS29500

Description
1mm
2mm
3mm
4mm
5mm
6mm

Dissecting set – 1 Student Dissecting Kit (Set of 14 Pcs)



Catalog#	Description
11-100	111-2200 Glow Pipe = 1 Pce 111-2210 Probe Needle Str = 1 Pce 111-2220 Probe Needle Angled Tip = 1 Pce 111-2222 Arrow Needle Str = 1 Pce 111-2232 Flexible Spatula = 1 Pce 352950KNIFE HANDLE - (B.P HANDLE) Size 3, 352953KNIFE HANDLE - (B.P HANDLE)Size 4, 996666 Razor = 1 Pce 111-2242 Probe Round Str = 1 Pce 144300 Iris Scissor Str = 1 Pce 101140 Operating Scissor Str = 1 Pce 465110 Thumb Dressing Forceps = 1 Pce 996565 Chain Hook = 1 Pce Scalpel Blades = 1 Set (2 Pcs)

BLOW PIPE



Catalog#	Description
111-2200	BLOW PIPE - 5"
111-2210	PROBE NEEDLE - STR 5"
111-2220	PROBE NEEDLE - ANGLED - 5"

ARROW NEEDLE

C#atolog#	Description
111-2220	ARROW NEEDLE - 5"

FLEXIBLE SPATULA



Catalog#	Description
111-2232	FLEXIBLE SPATULA

RAZOR



Catalog#	Description
996666	RAZOR

PROBE ROUND



Catalog	Description
111-2242	PROBE ROUND - STR 5"

Chain hook



Catalog	Description
996565	Chain hook

Universal ENT set



Catalog#
F1-500

Description
Universal ENT set

Diagnostic -Otoscope set



Catalog#
F1-501

Description
Diagnostic -Otoscope set

Diagnostic -Ophthalmoscope Set



Catalog#	Description
F1-5011	Diagnostic -Ophthalmoscope Set

Diagnostic -Plastic Stick hammer



Catalog#	Description
6-1-016	Diagnostic -Plastic Stick hammer 12"

Diagnostic - PEDI Size Mc Intosh Type (Curved Blades) Set



Catalog#
3-150 P

Description

Diagnostic - PEDI Size
Mc Intosh Type (Curved Blades)
Set of 3 Blades (00,0,1) + 1 Handle

CONTAINS:

33150-H - HANDLE

33150-00 - BLADE

33150-0 - BLADE

33150-1 - BLADE

Laryngoscope Handles



Catalog#
33150-H

Description

Laryngoscope Handles - Adult

Laryngoscope Handles



Catalog#
33150-PH

Description

Laryngoscope Handles - Pedia

Laryngoscope Handles – Optical Fiber



Catalog#
33150-OF

Description
Laryngoscope Handles – Optical Fiber

Mcintosh Blade

Catalog#
33150-00

Description
Mcintosh Blade size 00 - 6.9 CM

Mcintosh Blade



Catalog#
33150-0

Description
Mcintosh Blade size 0 – 8 CM

Mcintosh Blade



Catalog#
33150-1

Description
Mcintosh Blade size 1 – 10.5 CM

Mcintosh Blade



Catalog#
33150-3

Description
Mcintosh Blade size 3 – 19.5 CM

Mcintosh Blade



Catalog#
33150-4

Description
Mcintosh Blade size 4 - 20.5 CM

Mcintosh Blade



Catalog#
33150-5

Description
Mcintosh Blade size 00 - 6.9 CM

Mcintosh Blade

Catalog#
33150-00 OF

Description
Mcintosh Blade size 00 OPTICAL FIBER

Mcintosh Blade



Catalog#
33150-0 OF

Description
Mcintosh Blade size 0 OPTICAL FIBER

Mcintosh Blade



Catalog#	Description
33150-1 OF	Mcintosh Blade size 1 OPTICAL FIBER

Mcintosh Blade



Catalog#	Description
33150-2 OF	Mcintosh Blade size 2 OPTICAL FIBER

Mcintosh Blade



Catalog#	Description
33150-3 OF	Mcintosh Blade size 3 OPTICAL FIBER

Mcintosh Blade



Catalog#	Description
33150-4 OF	Mcintosh Blade size 4 OPTICAL FIBER

Mcintosh Blade



Catalog#
33150-5 OF

Description
Mcintosh Blade size 5 OPTICAL FIBER

Diagnostic - Adult Size Mc Intosh Type (Curved Blades) Set



Catalog#
3-150

Description
Diagnostic - Adult Size Mc Intosh Type (Curved Blades)
Set of 3 Blades (1,2,3) + 1 Handle
CONTAINS:
33150-H - HANDLE
33150-1 - BLADE
33150-2 - BLADE
33150-3 - BLADE

Diagnostic - Adult Size Mc Intosh Type (Curved Blades)



Catalog#
3-150-5

Description
Diagnostic - Adult Size Mc Intosh Type (Curved Blades)
Set of 5 Blades (0,1,2,3,4) + 1 Handle
CONTAINS:
33150-H - HANDLE
33150-1 - BLADE
33150-2 - BLADE
33150-3 - BLADE
33150-4 - BLADE
33150-5 - BLADE

Diagnostic - Adult Size Miller Type (STR Blades)



Catalog#
3-160

Description
Diagnostic - Adult Size Miller Type (STR Blades)
Set of 3 Blades (1,2,3) + 1 Handle
CONTAINS:
33150-H - HANDLE
93160-1 - BLADE
93160-2 - BLADE
93160-3 - BLADE

MILLER BLADE



Catalog#
93160-00

Description
MILLER BLADE SIZE 00 - 6.9 CM

MILLER BLADE



Catalog#
93160-0

Description
MILLER BLADE SIZE 0 - 8 CM

MILLER BLADE



Catalog#
93160-1

Description
MILLER BLADE SIZE 1 - 10.5 CM

MILLER BLADE



Catalog#
93160-2

Description
MILLER BLADE SIZE 2 - 15.5 CM

MILLER BLADE



Catalog#
93160-3

Description
MILLER BLADE SIZE 3 - 19.5 CM

MILLER BLADE



Catalog#
93160-4

Description
MILLER BLADE SIZE 4 - 20.5 CM

MILLER BLADE



Catalog#
93160-5

Description
MILLER BLADE SIZE 5 - 22 CM

Diagnostic -Ear Wash Syringe



Catalog #	Description
37-0548	Diagnostic -Ear Wash Syringe 50 ml – 2Oz
37-0549	Diagnostic -Ear Wash Syringe 75 ml – 3 Oz
37-0550	Diagnostic -Ear Wash Syringe 100 ml – 4 Oz

BUNT'S HOLDER FOR STERILIER FCP (Mayo Clip)

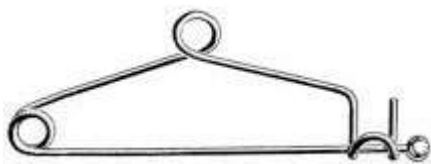

Catalog #	Description
88-1015	BUNT'S HOLDER FOR STERILIER FCP 14 CM (CLIP)

Hollow ware- Kidney basin tray



Catalog #	Description
709006	Hollow ware- Kidney basin tray – small – 6"
710008	Hollow ware- Kidney basin tray – medium – 8"
711010	Hollow ware- Kidney basin tray – Large – 10"

Hollow ware- Instrument tray with cover



Catalog #	Description
719068	Hollow ware- Instrument tray with cover – Small – 6x8"
720810	Hollow ware- Instrument tray with cover – Medium – 8x10"
721012	Hollow ware- Instrument tray with cover – Large – 10x12"

Hollow ware- Tray without Cover



Catalog #
722000

Description

Hollow ware- Tray without Cover 1.5 x 20x30 cm without Cover (mayo tray)

Hollow ware- Scalar tray



Catalog #
728555

Description

Hollow ware- Scalar tray 8.5x5x0.5 "

Hollow ware- Sterilization Drum



Catalog #

Description

- 711030 Hollow ware- Sterilization Drum XS – 5x5"
- 711030 Hollow ware- Sterilization Drum – Small – 6x6"
- 711030 Hollow ware- Sterilization Drum – Med – 8x8"
- 711060 Hollow ware- Sterilization Drum – Large – 10x10"

Hollow ware- Cotton container



Catalog#	Description
734000	Hollow ware- Cotton container with lid XS – 3x3
735000	Hollow ware- Cotton Container with lid Small – 4x4
736000	Hollow ware- Cotton Container with lid Med – 5x5
737000	Hollow ware- Cotton Container with lid Large – 5x7
738000	Hollow ware- Cotton Container with lid XL – 7x7

Hollow ware- Gallipot



Catalog#	Description
711002	Hollow ware- Gallipot XS – 2 Oz
711003	Hollow ware- Gallipot Small – 3 Oz
711004	Hollow ware- Gallipot Medium – 4 Oz
711005	Hollow ware- Gallipot Large – 5 Oz

KELLY PROCTOSCOPE



Catalog#	Description
53-134XS	KELLY PROCTOSCOPE XS 22X50
53-134S	KELLY PROCTOSCOPE S 22X100
53-134 M	KELLY PROCTOSCOPE M 22X140
53-134L	KELLY PROCTOSCOPE L 22X200

#

TILLEY NASAL DRESSING FORCEPS

Catalog #
43-0581

Description
TILLEY NASAL DRESSING FORCEPS 13.2 CM



TILLEY NASAL DRESSING FORCEPS 2,2MM 132MM

THUDICULUM NASAL SPECULA

Catalog #
41-0573

Description
THUDICULUM NASAL SPECULA SET/3

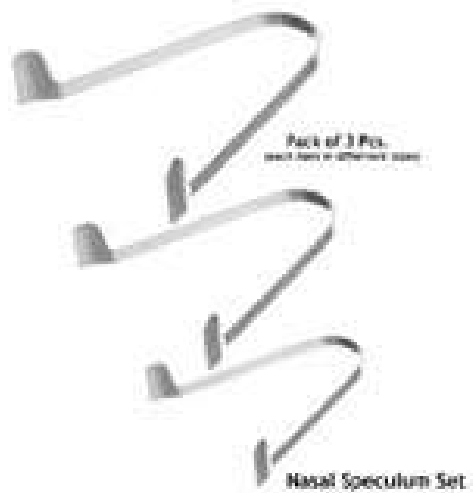

TELESCOPIC HAMMER



Catalog #
F1-524

Description
TELESCOPIC HAMMER

BECKMAN NASAL SPECULUM



Catalog #
431113

Description
BECKMAN NASAL SPECULUM 6"

#

BECKMAN NASAL SPECULUM



Catalog #
37-0542

Description
TROELTSCH EAR DRESSING FCP 13 CM

BECKMAN NASAL SPECULUM



Catalog #
452552

Description
MAGILL FORCEPS - infant 15 cm

EAR POLYPUS FORCEPS

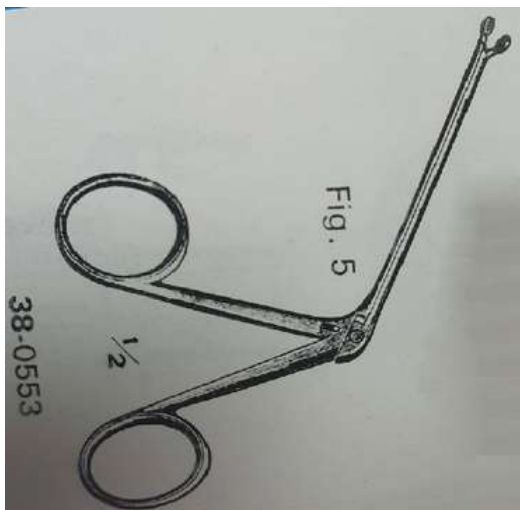

Catalog #
38-0553

Description
EAR POLYPUS FORCEPS FIG 5

HARTMANN ALLIGATOR FORCEPS



Catalog #

Description

GS55164-9	HARTMANN ALLIGATOR FORCEPS shaft size 9 cm
GS55164-12	HARTMANN ALLIGATOR FORCEPS Shaft size 12 cm
GS55164-14	HARTMANN ALLIGATOR FORCEPS Shaft size 14Cm
GS55164-18	HARTMANN ALLIGATOR FORCEPS Shaft size 18Cm
GS55164-20	HARTMANN ALLIGATOR FORCEPS Shaft size 20Cm
GS55164-24	HARTMANN ALLIGATOR FORCEPS Shaft size 24Cm
GS55164-28	HARTMANN ALLIGATOR FORCEPS Shaft size 28Cm
GS55164-30	HARTMANN ALLIGATOR FORCEPS Shaft size 30Cm
GS55164-36	HARTMANN ALLIGATOR FORCEPS Shaft size 36 cm

HARTMANN EAR HOOK



Catalog #
39-0562

Description
HARTMANN EAR HOOK - SHARP 16 CM

BISHOP EAR SPOON CURETTE



Catalog #	Description
40-0566-1	BISHOP EAR SPOON CURETTE SIZE 1
40-0566-2	BISHOP EAR SPOON CURETTE SIZE 2
40-0566-3	BISHOP EAR SPOON CURETTE SIZE 3
40-0566-4	BISHOP EAR SPOON CURETTE SIZE 4
GS47414	LISTON BONE CUTTER 25 CM

YOUNG TOUNGE HOLDING FCP



Catalog #	Description
68-0838	YOUNG TOUNGE HOLDING FCP 16 CM

TUNING FORK



Catalog ##	Description
2021003	TUNING FORK # 128

#

TUNING FORK



Catalog #	Description
2021004	TUNING FORK # 256

TUNING FORK



Catalog #
2021005

Description
TUNING FORK # 512

SUTURE PRACTICE KIT



Catalog # #
2021006

Description
SUTURE PRACTICE KIT

CONSISTS:

2021007 SUTURE PAD

- # 182310 Mosquito forceps Curved, 5-1/8" (13 cm)
- 460110 Operating Scissors S/B STR
- 181220 ADSON DRESSING FORCEPS 4-3/4" (12 cm)
- 181223 ADSON TISSUE FORCEPS x 2 teeth, 4-3/4" (12 cm)
- 352950 KNIFE HANDLE # 3
- GS41272 MAYO HEGAR NEEDLE HOLDERS 6" (15 cm)

SUTURE PAD



Catalog#	Description
2021007	SUTURE PAD

OPERATING SCISSORS



Catalog#	Description
460116	OPERATING SCISSORS, Sharp/Blunt, Curved, 6-3/4" (17 cm)
460117	OPERATING SCISSORS, Sharp/Blunt, Straight, 8-3/4" (22 cm)
460118	OPERATING SCISSORS, Sharp/Blunt, Curved, 8-3/4" (22 cm)

OPERATING SCISSORS, S/S



Catalog#	Description
460246	OPERATING SCISSORS, Sharp/Sharp, Straight, 6-3/4" (17 cm)
460247	OPERATING SCISSORS, Sharp/Sharp, ,Curved, 6-3/4" (17 cm)
460248	OPERATING SCISSORS, Sharp/Sharp, ,Straight, 8-3/4" (22 cm)
460249	OPERATING SCISSORS, Sharp/Sharp, ,Curved, 8-3/4" (22 cm)

CUSCO VAGINAL SPECULUM WITH FOLDING HANDS



Catalog #	Description
77-0906 XS	CUSCO VAGINAL SPECULUM WITH FOLDING HANDS - CENTER SCREW- DUCK BILL- (EXTRA NARROW) 1.9X8.3 CM
77-0906	CUSCO VAGINAL SPECULUM WITH FOLDING HANDS - CENTER SCREW- DUCK BILL- SMALL - 3.2X8.9 CM
77-0907	CUSCO VAGINAL SPECULUM WITH FOLDING HANDS - CENTER SCREW- DUCK BILL- MEDIUM - 3.5X10.2 CM
77-0908	CUSCO VAGINAL SPECULUM WITH FOLDING HANDS - CENTER SCREW- DUCK BILL- LARGE 3.5X11.4 CM

Ovum Forcep Smellie Patron

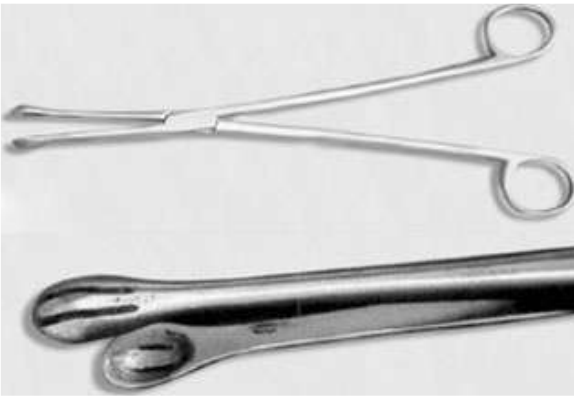

Catalog #
74-0886

Description

Ovum Forcep Smellie Patron S.S. 25 cm

MOLT Mouth Gag CHILD



Catalog #

66-0823M
66-0823L
66-0823S

Description #

MOLT Mouth Gag CHILD, WITH SILICONE TUBING 11.4 CM
MOLT Mouth Gag ADULT, WITH SILICONE TUBING 14 CM
MOLT Mouth Gag PEDIATRIC, WITH SILICONE TUBING 10.7 CM

DENTAL INSTRUMENTS

#

#

TOOTH EXTRACTING FORCEPS



Catalog #	Description
786	TOOTH EXTRACTING FORCEPS Lower premolars - Fig 1
787	TOOTH EXTRACTING FORCEPS lower premolars - Fig 2
788	TOOTH EXTRACTING FORCEPS upper molars, right - Fig 3
789	TOOTH EXTRACTING FORCEPS upper molars, left - Fig 4
790	TOOTH EXTRACTING FORCEPS upper molars - Fig 4 A
791	TOOTH EXTRACTING FORCEPS upper wisdoms - Fig 5
792	TOOTH EXTRACTING FORCEPS lower wisdoms - Fig 6
793	TOOTH EXTRACTING FORCEPS lower molars - Fig 7
794	TOOTH EXTRACTING FORCEPS lower molars - Fig 8
795	TOOTH EXTRACTING FORCEPS lower molars - Fig 8 A
796	TOOTH EXTRACTING FORCEPS lower roots - Fig 9
797	TOOTH EXTRACTING FORCEPS lower roots - Fig 9 A
798	TOOTH EXTRACTING FORCEPS lower roots - Fig 9 L
799	TOOTH EXTRACTING FORCEPS lower roots - Fig 9 L
800	TOOTH EXTRACTING FORCEPS lower roots, for children - Fig 9 S
801	TOOTH EXTRACTING FORCEPS upper roots - Fig 10
802	TOOTH EXTRACTING FORCEPS lower roots - Fig 11
803	TOOTH EXTRACTING FORCEPS upper roots - Fig 12
804	TOOTH EXTRACTING FORCEPS upper roots - Fig 12 A
805	TOOTH EXTRACTING FORCEPS upper roots - Fig 12 L
806	TOOTH EXTRACTING FORCEPS upper roots - Fig 1 Relax
807	TOOTH EXTRACTING FORCEPS upper roots - Fig 1 A Relax
808	TOOTH EXTRACTING FORCEPS upper roots - Fig 1 L Relax
809	TOOTH EXTRACTING FORCEPS upper wisdoms - Fig 2 Relax
810	TOOTH EXTRACTING FORCEPS upper wisdoms - Fig 2 A Relax
811	TOOTH EXTRACTING FORCEPS upper incisors and bicuspid - Fig 1
812	TOOTH EXTRACTING FORCEPS upper roots, anterior - Fig 1 B
813	TOOTH EXTRACTING FORCEPS lower wisdoms - Fig 2 Physick
814	TOOTH EXTRACTING FORCEPS lower molars, splitting forceps - Fig 3
815	TOOTH EXTRACTING FORCEPS upper molars - Fig 4 H
816	TOOTH EXTRACTING FORCEPS lower molars - Fig 13 Klein
817	TOOTH EXTRACTING FORCEPS upper incisors - Fig 14 Klein
818	TOOTH EXTRACTING FORCEPS lower incisors - Fig 15 Klein
819	TOOTH EXTRACTING FORCEPS upper premolars - Fig 16 Klein
820	TOOTH EXTRACTING FORCEPS Fractured or decayed upper teeth - with serrated tips
821	TOOTH EXTRACTING FORCEPS Upper roots - with serrated tips
822	TOOTH EXTRACTING FORCEPS Lower roots - with serrated tips
823	TOOTH EXTRACTING FORCEPS Lower roots - with serrated tips
824	TOOTH EXTRACTING FORCEPS Lower roots - with serrated tips
825	TOOTH EXTRACTING FORCEPS Upper roots - with serrated tips
826	TOOTH EXTRACTING FORCEPS Upper roots - with serrated tips
827	TOOTH EXTRACTING FORCEPS Upper roots - with serrated tips
828	TOOTH EXTRACTING FORCEPS Upper roots - with serrated tips
829	TOOTH EXTRACTING FORCEPS Upper roots - with serrated tips
830	TOOTH EXTRACTING FORCEPS Upper roots - with serrated tips

TOOTH EXTRACTING FORCEPS



Catalog #

Description

831	TOOTH EXTRACTING FORCEPS Upper roots and canines -
832	TOOTH EXTRACTING FORCEPS For separating upper molars
833	TOOTH EXTRACTING FORCEPS For separating upper molars
834	TOOTH EXTRACTING FORCEPS For separating lower molars
835	TOOTH EXTRACTING FORCEPS Lower roots with serrated tips
836	TOOTH EXTRACTING FORCEPS Lower incisor roots -
837	TOOTH EXTRACTING FORCEPS Lower roots with serrated tips
838	TOOTH EXTRACTING FORCEPS Upper molars, left serrated tips
839	TOOTH EXTRACTING FORCEPS Upper molars, right - with serrated tips
840	TOOTH EXTRACTING FORCEPS Upper molars, left - with serrated tips
841	TOOTH EXTRACTING FORCEPS Upper molars, right - with serrated tips
842	TOOTH EXTRACTING FORCEPS Upper third molars - with serrated tips
843	TOOTH EXTRACTING FORCEPS Upper third molars - with serrated tips
844	TOOTH EXTRACTING FORCEPS Lower roots - with serrated tips
845	TOOTH EXTRACTING FORCEPS Upper third molars, left -
846	TOOTH EXTRACTING FORCEPS Upper third molars, right -
847	TOOTH EXTRACTING FORCEPS Lower molars - with serrated tips
848	TOOTH EXTRACTING FORCEPS Lower roots - with serrated tips
849	TOOTH EXTRACTING FORCEPS Lower roots - with serrated tips
850	TOOTH EXTRACTING FORCEPS Lower roots - with serrated tips
851	TOOTH EXTRACTING FORCEPS Lower canines and premolars -
852	TOOTH EXTRACTING FORCEPS Lower third molars - with serrated tips
853	TOOTH EXTRACTING FORCEPS Lower third molars - with serrated tips
854	TOOTH EXTRACTING FORCEPS Lower third molars - with serrated tips
855	TOOTH EXTRACTING FORCEPS Lower third molars, left
856	TOOTH EXTRACTING FORCEPS Lower third molars, right
857	TOOTH EXTRACTING FORCEPS Lower molars
858	TOOTH EXTRACTING FORCEPS Lower third molars
859	TOOTH EXTRACTING FORCEPS Lower decayed molars or broken-down crowns
860	TOOTH EXTRACTING FORCEPS Upper molars, right - with serrated tips
861	TOOTH EXTRACTING FORCEPS Upper molars, left - with serrated tips
862	TOOTH EXTRACTING FORCEPS Broken-down lower molars -
863	TOOTH EXTRACTING FORCEPS Upper canines - with serrated tips
864	TOOTH EXTRACTING FORCEPS Upper third molars - with serrated tips
865	TOOTH EXTRACTING FORCEPS Lower roots - with serrated tips
866	TOOTH EXTRACTING FORCEPS Upper roots - with serrated tips

TOOTH EXTRACTING FORCEPS



Catalog #	Description
867	TOOTH EXTRACTING FORCEPS Universal extracting for upper teeth, in particular molars and premolars
868	TOOTH EXTRACTING FORCEPS Universal extracting for lower teeth, in particular molars and premolars
869	TOOTH EXTRACTING FORCEPS Upper roots - with serrated tips
869	TOOTH EXTRACTING FORCEPS Lower canines - with serrated tips
870	TOOTH EXTRACTING FORCEPS Lower roots - with serrated tips
871	TOOTH EXTRACTING FORCEPS Upper roots - with serrated tips
872	TOOTH EXTRACTING FORCEPS Lower roots - with serrated tips
873	TOOTH EXTRACTING FORCEPS Universal extracting forcep for upper
874	incisors and canines
875	TOOTH EXTRACTING FORCEPS Upper molars - with serrated tips
876	TOOTH EXTRACTING FORCEPS Lower incisors, premolar and roots -
877	TOOTH EXTRACTING FORCEPS Lower molars - with serrated tips
878	TOOTH EXTRACTING FORCEPS Upper incisors and canines - with serrated tips
879	TOOTH EXTRACTING FORCEPS Upper incisors and canines - with serrated tips
880	TOOTH EXTRACTING FORCEPS Lower incisors and canines - with serrated tips
881	TOOTH EXTRACTING FORCEPS Upper premolars - with serrated tips
882	TOOTH EXTRACTING FORCEPS Lower premolars - with serrated tips
883	TOOTH EXTRACTING FORCEPS Upper molars, right
884	TOOTH EXTRACTING FORCEPS Upper molars, left - with serrated tips
885	TOOTH EXTRACTING FORCEPS Lower molars - with serrated tips
886	TOOTH EXTRACTING FORCEPS Lower molars - with serrated tips
887	TOOTH EXTRACTING FORCEPS Lower roots - with serrated tips
888	TOOTH EXTRACTING FORCEPS Lower roots - with serrated tips
889	TOOTH EXTRACTING FORCEPS Upper roots - with serrated tips
890	TOOTH EXTRACTING FORCEPS Upper third molars - with serrated tips

TOOTH EXTRACTING FORCEPS

Catalog #	Description
921	TOOTH EXTRACTING FORCEPS Upper molars - with serrated tips
922	TOOTH EXTRACTING FORCEPS Upper molars, right - with serrated tips
923	TOOTH EXTRACTING FORCEPS Upper molars, left - with serrated tips
924	TOOTH EXTRACTING FORCEPS Upper roots - with serrated tips
925	TOOTH EXTRACTING FORCEPS Lower premolars - with serrated tips
926	TOOTH EXTRACTING FORCEPS Lower molars
927	TOOTH EXTRACTING FORCEPS Upper incisors and roots
928	TOOTH EXTRACTING FORCEPS Lower roots - with serrated tips
929	TOOTH EXTRACTING FORCEPS Lower incisors and canines - with serrated tips
930	TOOTH EXTRACTING FORCEPS Upper incisors - with serrated tips
931	TOOTH EXTRACTING FORCEPS Upper incisors - with serrated tips
932	TOOTH EXTRACTING FORCEPS Upper molars - with serrated tips
933	TOOTH EXTRACTING FORCEPS Upper roots - with serrated tips
934	TOOTH EXTRACTING FORCEPS Lower incisors - with serrated tips
935	TOOTH EXTRACTING FORCEPS Lower molars - with serrated tips
936	TOOTH EXTRACTING FORCEPS Lower roots - with serrated tips
937	TOOTH EXTRACTING FORCEPS Contents:0112-1, 0112-2, 0112-3, 0112-4, 0112-5, 01
938	TOOTH EXTRACTING FORCEPS Lower roots - with serrated tips
939	TOOTH EXTRACTING FORCEPS Upper roots - with serrated tips
940	TOOTH EXTRACTING FORCEPS Roots fragments
941	TOOTH EXTRACTING FORCEPS Roots fragments
994111	Tooth forceps Set/10 pcs (adult) (consists 914,915,916,917,918,919,920,921,922,923
994222	Tooth forceps Set/7 pcs (pedia) (consists 930,931,932,933,934,935,936)



Dental Elevators

Catalog #	Description
942	Elevators - lower jaw, left side - root elevator
943	Elevators - lower jaw, right side - root elevator
944	Elevators - Fig 1 - Bein- root elevator
945	Elevators - Fig 2 - Bein- root elevator
946	Elevators - Fig 0 - Bein
947	Elevators - Fig 3 - Bein
948	Elevators - Fig 4 - Bein
949	Elevators - Fig 5 - Bein
950	Elevators - Fig 6 - Bein
951	Elevators - Fig 1L - Seldin
952	Elevators - Fig 1R - Seldin
953	Elevators - Fig 2 Seldin
954	Elevators - Fig 3 Seldin
955	Elevators - Fig 4L Seldin
956	Elevators - Fig 4R Seldin
957	Elevators - Fig 3 Cryer
958	Elevators - Fig 4 Cryer
959	Elevators - Fig 12 Cryer
960	Elevators - Fig 27 Cryer

#

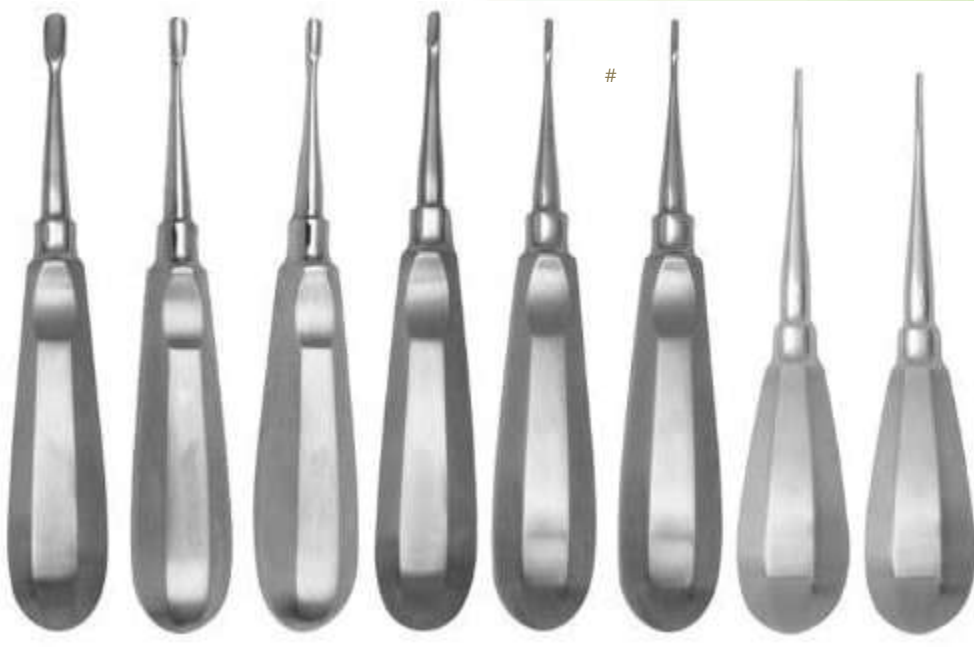

Dental Elevators

Catalog #	Description#
961	Elevators - Fig 28 Cryer
962	Elevators - Fig 27 S Cryer
963	Elevators - Fig 28 S Cryer
964	Elevators - Fig 1 Apical
965	Elevators - Fig 2 Apical
966	Elevators - Fig 3 Apical
967	Elevators - Fig 4 Apical
968	Elevators - Fig 1 Cryer
969	Elevators - Fig 2 Cryer
970	Elevators - Fig 1 Coupland
971	Elevators - Fig 2 Coupland
972	Elevators - Fig 3 Coupland
973	Root Elevator Fine Grove Tip
974	Root Elevator Wide Grove Tip
975	Root Elevator Serrated Grove Tip
976	Elevators - Fig 1 Flohr
977	Elevators - Fig 2 Flohr
978	Elevators - Fig 3 Flohr
979	Elevators - Fig 1 Kopp
980	Elevators - Fig 2 Kopp

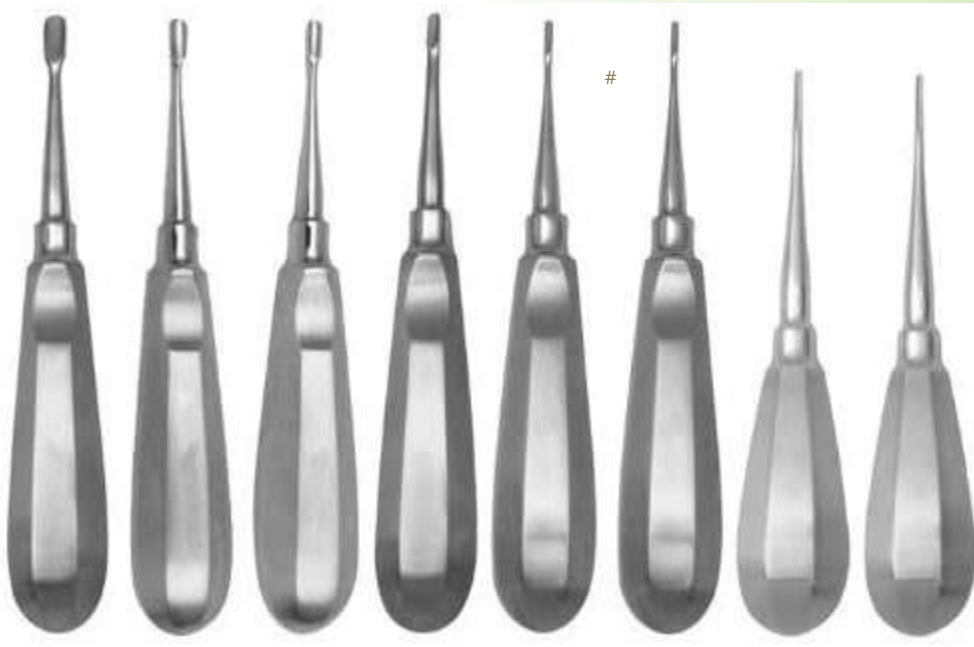

Dental Elevators

Catalog #	Description #
981	Elevators - Fig 3 Kopp
982	Elevators - Fig 4 Kopp
983	Elevators - Fig 5 Kopp
984	Elevators - Fig 6 Kopp
985	Elevators - Fig 1 Kopp
986	Elevators - Fig 2 Kopp
987	Elevators - Fig 3 Kopp
988	Elevators - Fig 4 Kopp
989	Elevators - Fig 1 Hylin
990	Elevators - Fig 2 Hylin
991	Elevators - Fig 1 Bein
992	Elevators - Fig 2 Bein
993	Elevators - Fig 3 Bein
994	Elevators - Fig 4 Bein
995	Elevators - Fig 1 Warwick-James
996	Elevators - Fig 2 Warwick-James
997	Elevators - Fig 3 Warwick-James
998	Elevators - Fig 1 London Hospital
999	Elevators - Fig 2 London Hospital
1000	Elevators - Fig 3 London Hospital



Dental Elevators

Catalog #	Description#
1001	Elevators - Ott
1002	Elevators - Fig 1 Pott
1003	Elevators - Fig 2 Pott
1004	Root Elevator With Grip Handle Patron Right
1005	Root Elevator With Grip Handle Patron Left
1006	Elevators - MD 1 Mead
1007	Elevators - MD-5 A Mead
1008	Elevators - MD-6 A Mead
1009	Elevators - MD-7 A Mead
1010	Elevators - MD-8 Mead
1011	Elevators - Lecluse
1012	Elevators - Fig 1 Chompret
1013	Elevators - Fig 2 Chompret
1014	Elevators - Fig 3 Chompret
1015	Elevators - Fig 4 Chompret
1016	Elevators - Apical
1017	Root Tip Elevator Pincel Patron Str Type
1018	Root Tip Elevator Pincel Patron Left
1019	Root Tip Elevator Pincel Patron Right
1020	Elevators - Fig 1 Heidbrink
1021	Elevators - Fig 2 Heidbrink
1022	Elevators - Fig 3 Heidbrink
1023	Elevators - Fig 1L Winter
1024	Elevators - Fig 1R Winter
1025	Elevators - Fig 2L Winter



Dental Elevators

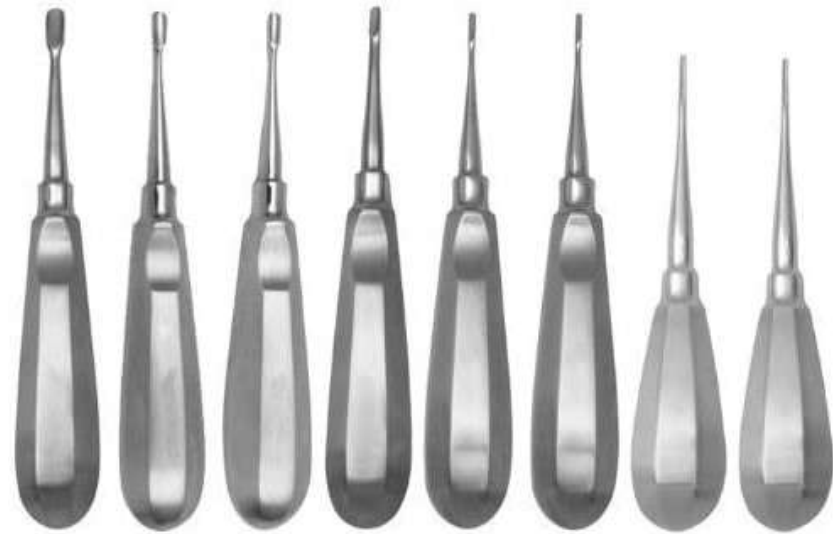

Catalog #	Description
1026	Elevators - Fig 2R Winter
1027	Elevators - Fig 11 L Winter
1028	Elevators - Fig 11 R Winter
1029	Elevators - Fig 12 L Winter
1030	Elevators - Fig 12 R Winter
1031	Elevators - Fig 14 L Winter
1032	Elevators - Fig 14 R Winter
1033	Elevators - Fig 1 Barry
1034	Elevators - Fig 2 Barry
1035	Elevators - Fig 3 Barry
1036	Elevators - Fig 4 Barry
1037	Elevators - Fig 11 Barry
1038	Elevators - Fig 12 Barry
1039	Elevators - Fig 17 Barry
1040	Elevators - Fig 18 Barry
1041	Handle For Elevator
1042	Elevators - Fig 22 Cryer
1043	Elevators - Fig 23 Seldin
1044	Elevators - Fig 26 Cryer
1045	Elevators - Fig 27 Cryer
1046	Elevators - Fig 28 Heidbrink
1047	Elevators - Fig 29 Heidbrink
# 1049	Elevators - Fig 31 Kopp
1050	Elevators - Fig 32 Kopp
1051	Elevators - Fig 33 Kopp
1052	Elevators - Fig 34 Kopp
1053	Elevators - Fig 35 Kopp
1054	Elevators - Fig 44 Kopp
1055	
# 1056	Elevators - Fig 10 Heidbrink
1057	Elevators - Fig 11 Winter
1058	Elevators - Fig 12 Winter
1059	Elevators - Fig 17 Barry
1060	Elevators - Fig 18 Barry
1061	Root Tip Elevator Pincel Patron Str Type Fig 20
1062	Grip Handle Elevator
1063	Tip Part For Grip Handle Elevator
1064	Grip Handle Elevator With Screw Part
1536	Ivory 160mm - ELEVATOR
1618	Mershon - ELEVATOR

FILLING INSTRUMENTS



Catalog #	Description
1118	Williams - FILLING INSTRUMENTS
1119	Williams- FILLING INSTRUMENTS
1120	Williams- FILLING INSTRUMENTS
1121	Williams- FILLING INSTRUMENTS
1122	Williams- FILLING INSTRUMENTS
1123	Williams- FILLING INSTRUMENTS
1124	Williams- FILLING INSTRUMENTS
1125	Williams- FILLING INSTRUMENTS
1126	White- FILLING INSTRUMENTS
1127	White- FILLING INSTRUMENTS
1128	White- FILLING INSTRUMENTS
1129	White- FILLING INSTRUMENTS
1130	White- FILLING INSTRUMENTS
1131	White- FILLING INSTRUMENTS
1132	White- FILLING INSTRUMENTS
1133	FILLING INSTRUMENTS
1134	FILLING INSTRUMENTS
1135	FILLING INSTRUMENTS
1136	FILLING INSTRUMENTS
1137	FILLING INSTRUMENTS
1138	FILLING INSTRUMENTS
1139	FILLING INSTRUMENTS
1140	FILLING INSTRUMENTS
# 1141	FILLING INSTRUMENTS
1142	Ash - FILLING INSTRUMENT
1143	Ash- FILLING INSTRUMENT
1144	Ash- FILLING INSTRUMENT
1145	Ash- FILLING INSTRUMENT
1146	Ash- FILLING INSTRUMENT
# 1147	Elliott- FILLING INSTRUMENT
1148	Bennett- FILLING INSTRUMENT

FILLING INSTRUMENTS



Catalog #	Description #
1149	Filling Instrument With Burnisher Double End
1150-1	Filling Instrument With Burnisher Double End
1151-2	Filling Instrument With Burnisher Double End
1152-3	Filling Instrument With Burnisher Double End
1153-4	Filling Instrument With Burnisher Double End
1154-5	Filling Instrument With Burnisher Double End
1155-6	Filling Instrument With Burnisher Double End
1156-7	Filling Instrument With Burnisher Double End
1157-8	Filling Instrument With Burnisher Double End
1158	Woodson - FILLING INSTRUMENT
1159-1	Woodson - FILLING INSTRUMENT
1160-2	Woodson - FILLING INSTRUMENT
1161	Dental Probe Single End- FILLING INSTRUMENT
1162-1	Dental Probe Single End- FILLING INSTRUMENT
1163-2	Dental Probe Single End- FILLING INSTRUMENT
1164-3	Dental Probe Single End- FILLING INSTRUMENT
1165-4	Dental Probe Single End- FILLING INSTRUMENT
1166-5	Dental Probe Single End- FILLING INSTRUMENT
1167-6	Dental Probe Single End- FILLING INSTRUMENT
1168-7	Dental Probe Single End- FILLING INSTRUMENT
1169-8	Dental Probe Single End- FILLING INSTRUMENT
1170-9	Dental Probe Single End- FILLING INSTRUMENT
1171-10	Dental Probe Single End- FILLING INSTRUMENT
1172-11	Dental Probe Single End- FILLING INSTRUMENT
1173-12	Dental Probe Single End- FILLING INSTRUMENT

FILLING INSTRUMENTS

Catalog #	Description
1174	Dental Bunisher Egg Style Single End White Patron- FILLING INSTRUMENT
1175-1	Dental Bunisher Egg Style Single End White Patron- FILLING INSTRUMENT
1176-2	Dental Bunisher Egg Style Single End White Patron- FILLING INSTRUMENT
1177-3	Dental Bunisher Egg Style Single End White Patron- FILLING INSTRUMENT
1178-4	Dental Bunisher Egg Style Single End White Patron- FILLING INSTRUMENT
1179-5	Dental Bunisher Egg Style Single End White Patron- FILLING INSTRUMENT
1180-6	Dental Bunisher Egg Style Single End White Patron- FILLING INSTRUMENT
1188	Heidemann - FILLING INSTRUMENT
1189-1	Heidemann - FILLING INSTRUMENT
1190-2	Heidemann - FILLING INSTRUMENT
1191	Filling Instrument With Ball Patron Double End
1192-1	Filling Instrument With Ball Patron Double End
1193-2	Filling Instrument With Ball Patron Double End
1194-3	Filling Instrument With Ball Patron Double End
1195-4	Filling Instrument With Ball Patron Double End
1196	Filling Instrument With Flat Tipl Patron Double End
1197-1	Filling Instrument With Flat Tipl Patron Double End
1198-2	Filling Instrument With Flat Tipl Patron Double End
1206	Filling Instrument With Flat Tipl Patron Double End
1207-1	Filling Instrument With Flat Tipl Patron Double End
1208-2	Filling Instrument With Flat Tipl Patron Double End
1209-3	Filling Instrument With Flat Tipl Patron Double End
1210-4	Filling Instrument With Flat Tipl Patron Double End
1211-5	Filling Instrument With Flat Tipl Patron Double End
1212-6	Filling Instrument With Flat Tipl Patron Double End
1213-7	Filling Instrument With Flat Tipl Patron Double End
1214-8	Filling Instrument With Flat Tipl Patron Double End



DENTAL CURETTE



Catalog #	Description
1199	Perionontan Curette With Gracey Tip Single End
1200-1	Perionontan Curette With Gracey Tip Single End
1201-2	Perionontan Curette With Gracey Tip Single End
1202-3	Perionontan Curette With Gracey Tip Single End
1203-4	Perionontan Curette With Gracey Tip Single End
1204-5	Perionontan Curette With Gracey Tip Single End
1205-6	Perionontan Curette With Gracey Tip Single End
1235	Fig HU 1/2 - Curette
1236	Fig 2R/2L Columbia- Curette
1237	Fig 4R/4L Columbia- Curette
1238	Fig 13/14 Columbia- Curette
1239	Fig 413/412- Curette
1240	Fig 411/414- Curette Zerfing- Curette
1241	Fig HU 1/2 - Curette
1248	Fig 2R/2L Columbia- Curette
1249	Fig 4R/4L Columbia- Curette
1250	Fig 13/14 Columbia- Curette
1251	Fig 413/412- Curette
1252	Fig 411/414 - - Curette
1253	Zerfing-- Curette
1254	Fig 1/2 Gracey Curette
1255	Fig 3/4 GraceyCurette
1256	Fig#5/6 GraceyCurette
1257	Fig 7/8 GraceyCurette
1258	Fig 9/10 Gracey Curette
1259	Fig 11/12 Gracey Curette
1260	Fig 13/14 Gracey Curette
1261	Fig 11/14 Gracey Mesial Distal Curette
1262	Fig 12/13 Gracey Mesial Distal Curette
1263	Fig #1/2 Gracey AF/type Curette
1264	Fig 3/4 Gracey AF/type Curette
1265	Fig 5/6 Gracey AF/type Curette
1266	Fig 7/8 Gracey AF/type Curette
1267	Fig 11/12 Gracey AF/type Curette
1268	Fig 13/14 Gracey AF/type Curette
1269	Fig 15/16 Gracey AF/type Curette
1270	Fig 1/2 Gracey MF/type Curette
1271	Fig 3/4 Gracey MF/type Curette
1272	Fig 5/6 Gracey MF/typeCurette
1273	Fig 7/8 Gracey MF/typeCurette
1274	Fig 11/12 Gracey MF/type Curette
1275	Fig 11/12 Gracey MF/type Curette

DENTAL CURETTE



Catalog #	Description
1276	Fig 13/14 Gracey MF/type Curette
1277	Fig 15/16 Gracey MF/type Curette
1278	Gracey AF/type - CURETTE
1279	Fig 1/2 Gracey AF/type- CURETTE
1280	Fig 3/4 Gracey AF/type- CURETTE
1281	Fig 5/6 Gracey AF/type- CURETTE
1282	Fig 7/8 Gracey AF/type- CURETTE
1283	Fig 11/12 Gracey AF/type- CURETTE
1284	Fig 13/14 Gracey AF/type- CURETTE
1285	Fig 15/16 Gracey AF/type- CURETTE
1286	Fig 1/2 Gracey MF/type- CURETTE
1287	Fig 3/4 Gracey MF/type- CURETTE
1288	Fig 5/6 Gracey MF/type- CURETTE
1289	Fig 7/9 Gracey MF/type- CURETTE
1290	Fig 11/12 Gracey MF/type- CURETTE
1291	Fig 13/14 Gracey MF/type- CURETTE
1292	Fig 15/16 Gracey MF/type- CURETTE
1293	Fig 1 Goldman - Fax- CURETTE
1294	Fig 2 Goldman - Fax- CURETTE
1295	Fig 3 Goldman - Fax- CURETTE
1296	Fig 4 Goldman - Fax- CURETTE
1297	Fig 21 Goldman - Fax- CURETTE
1298	Fig 5 Goldman - Fax- CURETTE
1299 #	Fig 13S/14S Mc Call- CURETTE
1300	Fig 7/8 Younger-Good- CURETTE
1301	Fig U15 Towner- CURETTE
1302	Fig 6 Crane - Kaplan - CURETTE
1303	Fig 6S Crane - Kaplan - CURETTE
1304	Fig 2/3 Taylor- CURETTE
1305	Fig 204S- CURETTE
1306 #	Fig U15/33 Towner Jaquette- CURETTE
1307	Fig 2R/2L Columbia - CURETTE
1308	Fig 4R/4L Columbia- CURETTE
1309	Fig 13/14 Columbia - CURETTE
1310	Fig 1 Jaquette- CURETTE
1311	Fig 2 Jaquette- CURETTE
1312	Fig 3 - CURETTE
1422	Hemingway Fig 1 - BONE CURETTE
1423	Hemingway Fig 2- BONE CURETTE
1424	Hemingway Fig 3- BONE CURETTE
1425	Lucas Fig 85- BONE CURETTE
1426	Lucas Fig 86- BONE CURETTE
1427	Lucas Fig 87- BONE CURETTE

Dental Pliers

Catalog #	Description
1428	Adams pliers for bending wires up to 0.7 mm. (.28")
1429	Adams pliers for bending wires up to 0.7 mm. (.28")
1430	Tweed loop forming pliers. For forming loop in wires up to 0.56mm (.22")
1431	Aderer three jaws bending pliers. For wires up to 0.7mm (.28")
1432	Aderer three jaws bending pliers. For wires up to 0.7mm (.28")
1433	Micro-miniature light wire cutter.
1434	Wire cutter. - PLIERS
1435	Wire cutter. - PLIERS
1436	Wire cutter. - PLIERS
1437	Flat nose pliers with smooth beaks for bending wires up to 0.7mm (.028")
1438	Bending wires up to 0.7 mm (.028") - PLIERS
1439	Bending wires up to 0.7 mm (.028") - PLIERS
1440	Bending wires up to 0.7 mm (.028") - PLIERS
1441	Nance loop closing pliers,
1442	Universal pliers for bending wires up to 0.9mm (.035") or cutting up to 0.7mm (.028")
1443	Stainless steel pliers tray standard dimensions
1444	Universal pin roughening, cutting and bending pliers.
1445	Reynolds contouring pliers
1446	"Lingual arch pliers" Weingart pliers with serrated points
1447	De La Rosa arch forming pliers
1448	Arch forming pliers
1449	Waldsachs universal pliers
1450	Round and Concave pliers
1451	Tweed loop forming pliers. #
1452	Tweed Loop Forming Pliers
1453	Single diameter loop forming pliers.
1454	Distal end cutter-- - PLIERS
1455	Mico - distal end cutter - - PLIERS
1456	Direct bonding bracket remover-- - PLIERS
1457	Direct bond attachment remover (angeled). - PLIERS
1458	Wire bending pliers. For wires up to 0.9mm (.036")
1459	Wire bending pliers. For wires up to 0.9mm (.036")
1460	Bird Beak Angle pliers



Dental Pliers

Catalog #	Description
1461	Double rounded jaw wire bending pliers. For wires up to 0.7mm (.028")
1462	Bird beak pliers
1463	Double rounded jaw wire bending pliers. For wires up to 0.7mm (.028")
1464	USA Model 125mm - PLIERS
1465	Waldron 125mm - PLIERS
1466	How 140mm - PLIERS
1467	How 145mm - PLIERS
1468	Adams 125mm - PLIERS
1469	Angle 125mm - PLIERS
1470	young 130mm - PLIERS
1471	Nance 130mm - PLIERS
1472	Weingart 140mm - PLIERS
1473	Johnson 130mm - PLIERS
1474	Mc Kellops 155mm - PLIERS
1475	Universal 150mm - PLIERS
1476	Waldsachs 155mm - PLIERS
1477	Aderer 125mm - PLIERS
1478	Nance 130mm - PLIERS
1479	Langenbeck 140mm - PLIERS
1480	Langenbeck 130mm - PLIERS
1481	Langenbeck 130mm - PLIERS
1482	Peeso 125mm - PLIERS
1483	Goslee 125mm - PLIERS
1484	Fischer 140mm - PLIERS
1485	Andresen 130mm - PLIERS
1486	Schwarz 130mm - PLIERS
1487	MSY 130mm - PLIERS
1488	Langenbeck 125mm - PLIERS
1489	End Cutter Plier W/Out TC 140mm
1490	Orthodontic Plier With Screw Patron

#

#



Dental Pliers

Catalog #	Description#
1491	Orthodontic Plier With Screw Patron
1492	Orthodontic Plier With Screw Patron
1493	Orthodontic Plier With Screw Patron
1494	Orthodontic Plier With Screw Patron
1495	Orthodontic Plier With Screw Patron
1496	Orthodontic Plier With Screw Patron
1497	Orthodontic Plier With Screw Patron
1498	Orthodontic Plier With Screw Patron
1499	Orthodontic Plier With Screw Patron
1500	Orthodontic Plier With Screw Patron
1501	Orthodontic Plier With Screw Patron
1502	Orthodontic Plier With Screw Patron
1503	Orthodontic Plier With Screw Patron
1504	Orthodontic Plier With Screw Patron
1505	Orthodontic Plier With Screw Patron
1506	Orthodontic Plier With Screw Patron
1507	Orthodontic Plier With Screw Patron
1508	Orthodontic Plier With Screw Patron
1509	Orthodontic Plier With Screw Patron
1510	Orthodontic Plier With Screw Patron
1511	Orthodontic Plier With Screw Patron
1512	Orthodontic Plier With Screw Patron
1513	Orthodontic Plier With Screw Patron
1514	Orthodontic Plier With Screw Patron
1636	Bohm 11.5cm - PLIERS
1637	Bohm 14.5cm - PLIERS
1638	Furrer 16cm - PLIERS
1639	Furrer 16cm - PLIERS
1519	Orthodontic Plier With Screw Patron



Dental probe



Catalog #	Description
1343	Diagnostic Probe Round Handle Patron Single End Fig 23
1344	Diagnostic Probe Round Handle Patron Single End Fig 6
1345	Diagnostic Probe Round Handle Patron Single End Fig 8
1346	Diagnostic Probe Round Handle Patron Single End Fig 9
1347	Diagnostic Probe Round Handle Patron Single End Fig 17
1348	Diagnostic Probe Round Handle Patron Single End Fig 3 Rein
1349	Diagnostic Probe Round Handle Patron Double End Fig 23/17
1350	Diagnostic Probe Round Handle Patron Double End Fig 17
1351	Periodontal Pocket Probe With Lazer Marked Tip Single End Fig CP-C
1352	Periodontal Pocket Probe With Lazer Marked Tip Single End Fig CP-11
1353	Periodontal Pocket Probe With Lazer Marked Tip Single End Fig CP-12
1354	Periodontal Pocket Probe With Lazer Marked Tip Single End Fig CP-12S O.M.S
1355	Williams - PERIODONTAL PROBE
1356	Merrit A- PERIODONTAL PROBE
1357	Merrit B- PERIODONTAL PROBE
1358	Goldman Fox- PERIODONTAL PROBE
1359	University of Michigon - PERIODONTAL PROBE
1360	Periodontal Pocket Probe With Lazer Marked Tip Single End
1375	Fig O.M.S O.M.S - PROBE
1376	Fig 2N Nabers - PERIODONTAL PROBE
1377	Fig 23 Williams - PERIODONTAL PROBE
1378	Williams- PERIODONTAL PROBE
1379	Fig 1 Luks- PERIODONTAL PROBE
1380	Fig 2 Luks- PERIODONTAL PROBE
1381	Fig 3 Luks- PERIODONTAL PROBE
1382	Fig 4 Luks- PERIODONTAL PROBE
1398	Endodontic Probe Double End Hollow Handle Fig 6/1
1399	Endodontic Probe Double End Hollow Handle Fig 6/17
1400	Endodontic Probe Double End Hollow Handle Fig 6/23
1401	Endodontic Probe Double End Hollow Handle Fig 31L
1402	Endodontic Probe Double End Hollow Handle Fig 32L
1403	Endodontic Probe Double End Hollow Handle Fig 33L
1515	Scalar Probe
1516	Scalar Probe
1517	Scalar Probe
1518	Scalar Probe

Dental Impression Trays



Catalog #	Description #
1065	Dental Impression Tray
1066	Dental Impression Tray
1067	Dental Impression Tray
1068	Dental Impression Tray
1069	Dental Impression Tray
1070	Dental Impression Tray
1071	Dental Impression Tray
1072	Dental Impression Tray
1073	Dental Impression Trays Set of 10 Pcs
1074	Dental Impression Tray
1075	Dental Impression Tray
1076	Dental Impression Tray
1077	Dental Impression Tray
1078	Dental Impression Tray
1079	Dental Impression Tray
1080	Dental Impression Tray
1081	Dental Impression Tray
1082	Dental Impression Tray
1083	Dental Impression Tray
1084	Dental Impression Tray
1085	Dental Impression Tray
1086	Dental Impression Tray
1087	Dental Impression Tray
1088	Dental Impression Tray
1089	Dental Impression Tray
1090	Dental Impression Tray
1091	Dental Impression Tray
1092	Dental Impression Tray
1093	Dental Impression Tray
1094	Dental Impression Tray
1095	Dental Impression Tray
1096	Dental Impression Tray
1097	Dental Impression Tray
1098	Dental Impression Tray
1099	Dental Impression Tray
1100	Dental Impression Tray

Dental Impression Trays



Catalog #	Description #
1101	Dental Impression Tray
1102	Dental Impression Tray
1103	Dental Impression Tray
1104	Dental Impression Tray
1105	Dental Impression Tray
1106	Dental Impression Tray
1107	Dental Impression Tray
1108	Dental Impression Tray
1109	Dental Impression Tray
1110	Dental Impression Tray
1111	Dental Impression Tray
1112	Dental Impression Tray
1113	"Dental Impression Tray SET OF 6 TRAYS: REGULAR PERFORATED S.M.L....UPPER S.M.L....LOWER SET OF 8 TRAYS: XS.S.M.L....UPPER XS.S.M.L....LOWER SET OF 8 TRAYS: S.M.L.XL....UPPER S.M.L.XL....LOWER SET OF 10 TRAYS: XS.S.M.L.XL....UPPER XS.S.M.L.XL....LOWER"
1114	"Dental Impression Tray SET OF 6 TRAYS: REGULAR NON PERFORATED- S.M.L....UPPER S.M.L....LOWER SET OF 8 TRAYS: XS.S.M.L....UPPER XS.S.M.L....LOWER SET OF 8 TRAYS: S.M.L.XL....UPPER S.M.L.XL....LOWER SET OF 10 TRAYS: XS.S.M.L.XL....UPPER XS.S.M.L.XL....LOWER"
1114A	"Dental Impression Tray SET OF 8 TRAYS: PERFORATED WITHOUT RIM - XS.S.M.L....UPPER XS.S.M.L...LOWER"
1115	Dental Impression Tray SET OF 3 TRAYS - PARTIAL PERFORATED
1116	"Dental Impression Tray SET OF 8 TRAYS: FULL DENTURE PERFORATED- S.M.L.XL....UPPER S.M.L.XL...LOWER"
1117	"Dental Impression Tray SET OF 6 TRAYS: ORTHODONTIAL PERFORATED- S.M.L...UPPER S.M.L...LOWER"

AMALGAM CARRIER



Catalog #	Description
1645	Medium-Large - AMALGAM CARRIER
1646	Medium-Jumbo- AMALGAM CARRIER
1647	Large-Jumbo- AMALGAM CARRIER
1648	Jumbo-Jumbo- AMALGAM CARRIER
1649	Medium - AMALGAM CARRIER
1650	Large- AMALGAM CARRIER
1651	Jumbo- AMALGAM CARRIER
1652	14cm - AMALGAM GUN CARRIER
1653	14cm- AMALGAM GUN CARRIER
1654	Amalgam Gun 90 Agnled Tip CARRIER
1655	Amalgam Well Non Skid Base CARRIER

Articulator



Catalog #	Description
1656	Dental Articulator
1657	Dental Articulator
1658	Plate For Dental Articulator
1659	Disc For Dental Articulator
1660	Dental Articulator
1661	Dental Articulator
1662	Dental Articulator
1663	Dental Articulator

CHISELS



#Catalog	Description
1702	Ochsenbein Fig 1 - CHISELS
1703	Ochsenbein Fig 2 - CHISELS
1704	Gardner Fig 1 - CHISELS
1705	Gardner Fig 2- CHISELS
1706	Gardner Fig 5- CHISELS
1707	Gardner Fig 5R- CHISELS
1708	Gardner Fig 6- CHISELS
1709	Wakefield Fig 1W- CHISELS
1710	Wakefield Fig 2W- CHISELS
1711	Buckley Fig 3- CHISELS
1712	mm 3 - Partsch cm 13.5- CHISELS
1713	mm 4 - Partsch cm 13.5- CHISELS
1714	mm 5 - Partsch cm 13.5- CHISELS
1715	mm 6 - Partsch cm 13.5- CHISELS
1716	mm 3 - Partsch cm 13.5- CHISELS
1717	mm 4 - Partsch cm 13.5- CHISELS
1718	mm 5 - Partsch cm 13.5- CHISELS
1719	mm 6 - Partsch cm 13.5- CHISELS
1720	mm 3 - Partsch cm 17- CHISELS
1721	mm 4 - Partsch cm 17- CHISELS
1722	mm 5 - Partsch cm 17- CHISELS
1723	mm 6 - Partsch cm 17- CHISELS
1724	mm 3 - Partsch cm 17- CHISELS
1725	mm 4 - Partsch cm 17- CHISELS
1726	mm 5 - Partsch cm 17- CHISELS
1727	mm 6 - Partsch cm 17 - CHISELS
1731	3mm - Buckley 15cm , 6" - CHISELS
1732	4mm - Buckley 15cm , 6"- CHISELS
1733	5mm - Buckley 15cm , 6"- CHISELS
1734	4mm - Buckley 15cm , 6"- CHISELS
1735	4mm - Buckley 15cm , 6"- CHISELS
1736	Killian - CHISELS
1737	Killian-Claus- CHISELS
1738	Obwegeser - 2.5mm- CHISELS
1739	Obwegeser - 4mm- CHISELS
1740	Miller- CHISELS
1741	Miller- CHISELS
1742	Miller- CHISELS
1743	Miller- CHISELS

condensers

Catalog #	Description
1383	Fig 1 Vertical condenser
1384	Fig 2 Vertical condenser
1385	Fig 3 Vertical condenser
1386	Fig 4 Vertical condenser
1387	Endodontic set - Measuring Plate Vertical condenser
1388	Fig 7 1/2 Schilder - CONDENSER
1389	Fig 8 Schilder- CONDENSER
1390	Fig 8 1/2 Schilder- CONDENSER
1391	Fig 9 Schilder- CONDENSER
1392	Fig 9 1/2 Schilder- CONDENSER
1393	Fig 10 Schilder- CONDENSER
1394	Fig 10 1/2 Schilder- CONDENSER
1395	Fig 11 Scilder- CONDENSER
1396	Fig 11 1/2 Schilder- CONDENSER
1397	Fig 12 Schilder- CONDENSER



CROWN REMOVER

Catalog #	Description#
1619	Morell - CROWN REMOVER
1620	Morell- CROWN REMOVER
1621	Morell- CROWN REMOVER
1622	Morell- CROWN REMOVER
1623	Treymann- CROWN REMOVER
1624	Automatic Crown Remover With 2points
1625	Crown Remover Tip Round Pin Patron
1626	Crown Remover Tip Pointed Patron
1627	Crown Remover
1628	Tip Part of Crown Remover Tip Pointed Patron
1629	Tip Part of Crown Remover Tip Serrated Patron
1630	Tip Part of Crown Remover Tip Round Pin Patron
1632	Crown Remover
1633	Tip Part of Crown Remover Tip Pointed Patron
1634	Tip Part of Crown Remover Tip Angled Patron
1635	Crown Remover



DENTAL FILES

Catalog #	Description
1383	Wiliger 16cm, 6 1/4" - BONE FILES
1384	Henahan 17cm, 6 3/4"- BONE FILES
1385	Freer 19cm, 7 1/2"- BONE FILES
1386	Bennet 17cm, 6 3/4"- BONE FILES
1387	Seldin 19cm, 7 1/2"- BONE FILES
1388	Seldin 19.5cm, 7 3/4"- BONE FILES
1389	Fig.1S/2S Sugaraman - PERIODONTIA INSTRUMENT - FILES
1390	Fig. 3S/4S Sugaraman - PERIODONTIA INSTRUMENT- FILES
1391	Fig. 9/10 Sugaraman - PERIODONTIA INSTRUMENT- FILES
1392	Fig. 11/12 Buck- PERIODONTIA INSTRUMENT- FILES
1393	Fig. 3 Ochsendein- PERIODONTIA INSTRUMENT- FILES
1394	Fig. 4 Ochsendein- PERIODONTIA INSTRUMENT- FILES
1395	Fig. 36/37 Rhodes Back - Action- PERIODONTIA INSTRUMENT- FILES
1396	Fig. 1S/2S Sugarman- PERIODONTIA INSTRUMENT- FILES
1397	Fig 3S/4S Sugarman- PERIODONTIA INSTRUMENT- FILES
	Fig 9/10 Schluger- PERIODONTIA INSTRUMENT- FILES
	Fig. 11/12 Buck- PERIODONTIA INSTRUMENT- FILES
	Fig 3 Ochsenbein- PERIODONTIA INSTRUMENT- FILES
	Fig 4 Ochsenbein- PERIODONTIA INSTRUMENT- FILES
	Fig 36/37 Rhodes Back - Action - PERIODONTIA INSTRUMENT- FILES



Dental Syringes

Catalog #	Description#
1526	1.8ml - Catridge Syringe complete with 2 tips and without needles
1527	2.2ml - Catridge Syringe complete with 2 tips and without needles
1528	Tip Only, short - Syringe
1529	Tip Only, long- Syringe
1530	Water Syringe complete with 1 cannula (Lure-Lock)
1531	Metal water syringe, self-filling, with 1 cannula (Lure-Lock)
1532	Sparrel Barrel with plunger suitable for syringes - Syringe
1533	Cannula, only, with Luer-Lock connector suitable for syringes - Syringe
1534	Aspirating Syringe
1535	Aspirating Syringe
1536	Aspirating Syringe
1537	Dental Syringe Steel Made (injected Syring Enthesia)
1538	Aspirating Syringe
1539	Dental Syring Gun Patron
1521	Breech Loading Syringe
1522	Aspirating & Breech Syringe
1525	Aspirating Syringe



Excavator

Catalog #	Description #
1404	Excavator Double End Fig 5 - 1mm
1405	Excavator Double End Fig 14 - 1.2mm
1406	Excavator Double End Fig 17 - 1mm
1407	Excavator Double End Fig 18 - 1.2mm
1408	Excavator Double End Fig 19 - 1.6mm
1409	Excavator Double End Fig 20 - 2mm
1410	Excavator Double End Fig 243 ASH - 1mm
1411	Fig G2 ASH - 1.4mm - EXCAVATOR
1412	Excavator Double End Fig 1 - 0.8mm
1413	Excavator Double End Fig 2 - 0.8mm
1414	Excavator Double End Fig 11 - 1mm
1415	Excavator Double End Fig 12 - 1mm
1416	Excavator Double End Fig 21 - 1.2mm
1417	Excavator Double End Fig 22 - 1.2mm
1418	Excavator Double End Fig 31 - 1.6mm
1419	Excavator Double End Fig 32 - 1.6mm
1420	Excavator Double End Fig 41 - 2mm
1421	Excavator Double End Fig 42 - 2mm



HANDLE

Catalog #	Description#
1318	Mirror Handle Round Patron Satin Finish
1319	Mirror Handle Round Patron Black Coated
1320	Mirror Handle Round Patron Black Coated
1321	Mirror Handle Round Patron Shiny Finish Learning Patron
1322	Mirror Handle Round Patron Black Coated Finish Learning Patron
1323	Parallelometer mouth mirror handle
1324	Parallelometer mouth mirror + handle code 2101
1325	Plane handle - with cone-socket Fig 5 - 24 mm - MOUTH MIRROR
1326	Plane handle - with cone-socket Fig 4 - 22 mm- MOUTH MIRROR
1327	Magnifying handle - with cone-socket Fig 5 - 24 mm - MOUTH MIRROR
1328	Magnifying handle - with cone-socket Fig 4 - 22 mm - MOUTH MIRROR
1329	Cone - socket - HANDLE
1330	Cone - socket - HANDLE
1331	Cone - socket - HANDLE
1332	Set of 5 pieces - HANDLE
1333	Set of 5 pieces - HANDLE
1334	Set of 5 pieces Hollow, stainless steel - HANDLE



KNIFES



Catalog #	Description#
1229	Fig 7 Goldman - Fox - Gingivectomy Knives
1230	Fig 8 Goldman - Fox- Gingivectomy Knives
1231	Fig 9 Goldman - Fox- Gingivectomy Knives
1232	Fig 11 Goldman - Fox- Gingivectomy Knives
1233	Fig 3/4 Buck - Gingivectomy Knives
1234	Fig 5/6 Buck - Gingivectomy Knives
1242	Fig 7 Goldman - Fox - Gingivectomy Knives
1243	Fig 8 Goldman - Fox- Gingivectomy Knives
1244	Fig 9 Goldman - Fox- Gingivectomy Knives
1245	Fig 11 Goldman - Fox- Gingivectomy Knives
1246	Fig 3/4 Buck - Gingivectomy Knives
1247	Fig 5/6 Buck - Gingivectomy Knives
1569	Fahnenstock Fig 1, cm 12.5 - WAX KNIVES
1570	Fahnenstock Fig 2, cm 17- WAX KNIVES
1571	Lessmann Fig 1, cm 12.5- WAX KNIVES
1572	Lessmann Fig 2, cm 17- WAX KNIVES
1573	Con scodellino Fig 1, cm 12.5- WAX KNIVES
1574	Con scodellino Fig 2, cm 17- WAX KNIVES
1575	Plastes Knife Fig 1, cm 17- PLASTER KNIVES
1576	Gritman Fig 2, cm 17- PLASTER KNIVES
1577	Plastes Knife Fig 3, cm 16- PLASTER KNIVES
1578	Plastes Knife Fig 4, cm 16- PLASTER KNIVES
1579	Plastes Knife 18cm, 7 1/8"
1580	Plastes Knife 18cm, 7 1/8"
1581	17cm, 6 3/4" Gritman - - PLASTER KNIVES
1582	17cm, 6 3/4" Medicon- PLASTER KNIVES
1584	Antkoviak - KNIVES
1585	Ermert- KNIVES
1586	Ermert- KNIVES

MATRIX BAND



Catalog #	Description#
1551	"Matrix Band Strip Round Patron 1750-5mm x 100cm 1750-6mm x 100cm 1750-7mm x 100cm"
1552-7	Matrix Band Strip
1553-8	Matrix Band Strip
1554-9	Matrix Band Strip
1555-10	Matrix Band Strip
1556-11	Matrix Band Strip For Molars and Premolars
1557-12	Matrix Band Strip For Molars and Premolars
1558-13	Matrix Band Strip For Molars and Premolars
1559	Matrix Band Strip
1560	Molar Matrix Band Strip Molar
1561	Matrix Band Strip Molar
1562	Matrix Band Strip Molar
1563	Matrix Band Strip Tofflemire
1564	Matrix Band Strip Tofflemire
1565	Matrix Band Strip Tofflemire
1566	Matrix Band Strip Bicuspid
1567	Matrix Band Strip Bicuspid
1568	Matrix Band Strip Bicuspid
1569	Matrix Band Strip Bicuspid
1570	Matrix Band Strip Bicuspid
1571	Matrix Band Strip Bicuspid
1572	# Matrix Band Strip Molar
1573	Matrix Band Strip Molar
1574	Matrix Band Strip Molar
1575	Matrix Band Strip Round Patron

MIRRORS



Catalog #	Description#
1335	Plane Fig 6 26 mm - MIRRORS
1336	Plane Fig 5 24 mm- MIRRORS
1337	Plane Fig 4 22 mm- MIRRORS
1338	Fig 4 Rhodium 22 mm - Front surface mouth mirrors
1339	Magnifying - Fig 6 26mm- MIRRORS
1340	Magnifying - Fig 5 24 mm- MIRRORS
1341	Magnifying - Fig 4 22 mm- MIRRORS
1342	Fig 3 24 mm - Front surface mouth mirrors

RUBBER DAM CLAMPS

Catalog #	Description
1576-9	Winged - Labial Clamp
1577-9T	Winged - Edged Labial
1578-212	Clamp Winged - Cervical Clamp
1579-210	Winged - Labial Clamp
1580-00	Winged - For small teeth, elongated or with narrow collars - CLAMPS
1581-0	Winged - For small teeth, elongated or with narrow collars- CLAMPS
1582-WO	Wingless - For small teeth, elongated or with narrow collars- CLAMPS
1583-1	Winged - For general use with adjustable jaws according to gingival line shapes- CLA
1584-1T	Winged - For general use with adjustable jaws according to gingival line shapes- CLA
1585-W1	Wingless - For general use with adjustable jaws according to gingival line shapes- CL
1586-2A	Winged - For Premolars, With Elongated Collar- CLAMPS
1587-2AT	Edged, Winged - For Premolars, With Elongated Collar- CLAMPS
1588-W2A	Wingless - For Premolars, With Elongated Collar- CLAMPS
1589-2	Winged - For Premolars, With Elongated Collar- CLAMPS
1590-2T	Edged, Winged - For Premolars, With Elongated Collar- CLAMPS
1591-W2	Wingless - For Premolars, With Elongated Collar- CLAMPS
1592-29	Wingless- CLAMPS
1593-60	Wingless- CLAMPS
1594-3	Winged - For Small Lower Molars- CLAMPS
1595-W3	Wingless - For Small Lower Molars- CLAMPS
1596-4	Winged - For Small Lower Molars With Round clamps
1597-W4	Wingless - For Small Lower Molars With Round clamps
1598-7	Winged - For square lower molars- CLAMPS
1599-W7	Wingless-For square lower molars- CLAMPS
1600-8	Winged - For round upper molars- CLAMPS
1601-W8	Wingless - For round upper molars- CLAMPS
1602-8A	Winged - For Molar Roots- CLAMPS
1603-W8A	Wingless - For Molar Roots- CLAMPS
1604-12A	Winged - For partially broken molars- CLAMPS
1605-13A	Wingless - For partially broken molars- CLAMPS
1606-14	Winged - For round molars, partially broken, undersized or inclined- CLAMPS
1607-14T	Edged Winged - For round molars, partially broken, undersized or inclined- CLAMPS
1608-W14	Wingless - For round molars, partially broken, undersized or inclined- CLAMPS
1609-14A	Winged - For round molars, partially broken, undersized or inclined- CLAMPS
1610-W14A	Wingless - For round molars, partially broken, undersized or inclined- CLAMPS
1611-26	Wingless - For upper molars- CLAMPS
1612-51	Wingless - For upper molars- CLAMPS
1613-202	Winged - For big upper molars- CLAMPS
1614-205	Winged - For big upper molars - CLAMPS



Dental Spatulas



Catalog #	Description#
1541	Rigid Fig 1, cm 18.5 - WAX SPATULA
1542	Rigid Fig 2, cm 18- WAX SPATULA
1543	Flexible Fig 3, cm 18.5 - WAX SPATULA
1544	Flexible Fig 4, cm 19.5- WAX SPATULA
1545	Flexible Fig 5, cm 21.5- WAX SPATULA
1546	Flexible Fig 6, cm 20.5- WAX SPATULA
1547	Flexible Fig 7, cm 19.5 - - WAX SPATULA
1548	Rigid Fig 8, cm 20- WAX SPATULA
1549	Rigid Fig 9, cm 22.5- WAX SPATULA
1550	Le Cron - SPATULA
1551	Le Cron- SPATULA
1552	Le Cron- SPATULA
1553	MSY- SPATULA
1554	MSY- SPATULA
1555	Le Cron- SPATULA
1556	Hylin- SPATULA
1557	Hylin- SPATULA
1558	Hylin- SPATULA
1559	Zahle- SPATULA
1560	Zahle- SPATULA
1561	Zahle- SPATULA
1562	Gritman - SPATULA
1563	Beale- SPATULA
1564	Roach- SPATULA
1565	Vehe- SPATULA
1583	Spatula with wooden handle 22cm, 8 3/4"

SPREADER



Catalog #	Description#
1361	Fig 1 Spreader
1362	Fig 2 Spreader
1363	Fig 3 Spreader
1364	Fig 4 Spreader
1365	Fig 5 Spreader
1366	Fig 6 Spreader
1367	Fig 7 Spreader
1368	Fig 1 Machtou - Spreader
1369	Fig 2 Machtou- Spreader
1370	Fig 3 Machtou- Spreader
1371	Fig 4 Machtou- Spreader
1372	Fig 1 Spreader
1373	Fig 2 Spreader
1374	Fig 3 Spreader
1631	Crown Spreader, Crown Remove.

Dental Tweezer FORCEPS

Catalog #	Description
1587	College 15cm - smooth - TWEEZER FORCEPS
1588	College 15cm - serrated- TWEEZER FORCEPS
1589	College 15cm - smooth- TWEEZER FORCEPS
1590	College 15cm - serrated- TWEEZER FORCEPS
1591	College 15cm - smooth- TWEEZER FORCEPS
1592	College 15cm - serrated- TWEEZER FORCEPS
1593	College 15cm - smooth- TWEEZER FORCEPS
1594	College 15cm - serrated- TWEEZER FORCEPS
1595	Meriam 16cm - smooth- TWEEZER FORCEPS
1596	Meriam 16cm - serrated- TWEEZER FORCEPS
1597	Meriam 16cm - smooth- TWEEZER FORCEPS
1598	Meriam 16cm - serrated- TWEEZER FORCEPS
1599	Meriam 16cm - smooth- TWEEZER FORCEPS
1600	Meriam 16cm - serrated- TWEEZER FORCEPS
1601	Meriam 16cm - smooth- TWEEZER FORCEPS
1602	Meriam 16cm - serrated- TWEEZER FORCEPS
1603	College 14.5cm, 5 3/4" - serrated- TWEEZER FORCEPS
1604	Flagg 16cm, 6 1/4" - serrated- TWEEZER FORCEPS
1605	Flagg 16cm, 6 1/4" - smooth- TWEEZER FORCEPS Landgraf 15cm,
1606	6" - serrated, smooth- TWEEZER FORCEPS
1607	15, 5cm, 6 1/8" - smooth- TWEEZER FORCEPS
1608	15, 5cm, 6 1/8" - con cierre- TWEEZER FORCEPS
1609	London-College 15cm, 6" - serrated- TWEEZER FORCEPS
1610	London-College 15cm, 6" - smooth- TWEEZER FORCEPS
1611	London-College 15cm, 6" - serrated- TWEEZER FORCEPS
1612	London-College 15cm, 6" - smooth- TWEEZER FORCEPS
1613	CK1, 15cm, 6"- TWEEZER FORCEPS
1614	CK2, 15cm, 6"- TWEEZER FORCEPS
1615	GF2, 16cm, 6 1/4"- TWEEZER FORCEPS
1616	Gf1, 16cm, 6 1/4"- TWEEZER FORCEPS
1617	Kopp 15.5cm, 6 1/8"- TWEEZER FORCEPS
1618	Kopp 15.5cm, 6 1/8"- TWEEZER FORCEPS
1619	15cm, 6"- TWEEZER FORCEPS
1620	16, 5cm, 6 1/2"- TWEEZER FORCEPS



Dental Tweezer FORCEPS

Catalog #	Description
1621	15, 5cm, 6 1/8"- TWEEZER FORCEPS
1622	15, 5cm, 6 1/8"- TWEEZER FORCEPS
1623	London-College 15cm, 6"- TWEEZER FORCEPS
1624	London-College 15cm, 6"- TWEEZER FORCEPS
1625	Meriam 16cm, 6 1/4"- TWEEZER FORCEPS
1526	Allen 18cm, 7 1/8"- TWEEZER FORCEPS
1527	Albrecht 16cm, 6 1/4"- TWEEZER FORCEPS
1528	Albrecht 16cm, 6 1/4"- TWEEZER FORCEPS
1529	Cross Angled Dental Tweezer With Fiber Hanlde Angled Tip 16cm, 6 1/4" FORCEPS
1530	Cross Angled Dental Tweezer With Fiber Hanlde Str Flat Tip 16cm, 6 1/4" FORCEPS
1531	Cross Angled Dental Tweezer With Fiber Hanlde Str Sharp Pointed Tip FORCEPS
1640	Miller 15cm - ARTICULATOR FORCEPS
1641	Miller 15cm - - ARTICULATOR FORCEPS
1642	Kelly 14cm - FORCEPS
1643	Halstead-Mosquito 12cm- FORCEPS
1644	Micro-Mosquito 10cm- FORCEPS
1532	Young 105x95 Inox - RUBBER DAM FRAME FORCEPS
1533	Ivory 160mm - RUBBER DAM PUNCH FORCEPS
1534	Ainsworth 160mm - - RUBBER DAM PUNCH FORCEPS
1535	Ainsworth 160mm- RUBBER DAM PUNCH FORCEPS
1537	Stockes 175mm - RUBBER DAM CLAMP FORCEPS
1538	Brewer 175mm- RUBBER DAM CLAMP FORCEPS
1539	Washington 175mm- RUBBER DAM CLAMP FORCEPS
1540	White 175mm- RUBBER DAM CLAMP FORCEPS
1541	Ivory 170mm- RUBBER DAM CLAMP FORCEPS

